

# THE NEW ZOO AT ELK GROVE

## Schematic Plans



Sacramento Zoological Society  
3800 W. Land Park Drive  
Sacramento, CA USA



SHR Studios  
250 Madonna Way N.E. #270  
Bainbridge Island, WA 98110  
phone (206) 842 8332  
shrstudios.com



Date: September 22, 2023  
Project Location: Elk Grove, CA  
Prepared For: Sacramento Zoological Society



### Sheet Index:

**Cover Sheet**  
G101 COVER SHEET

**Civil**  
C-000 INDEX SHEET  
C-001 ALTA SURVEY  
C-002 ALTA SURVEY  
C-100 VEHICULAR ACCESS - CIRCULATION  
C-200 PARKING LOT LAYOUT PLAN  
C-300 FIRE PLAN  
C-400 OVERALL UTILITY PLAN  
C-401 UTILITY PLAN  
C-402 UTILITY PLAN  
C-500 OVERALL STORMWATER PLAN  
C-501 STORMWATER PLAN  
C-502 STORMWATER PLAN  
C-601 STORMWATER QUALITY PLAN  
C-602 STORMWATER QUALITY PLAN  
C-603 STORMWATER QUALITY PLAN  
C-700 MASS GRADING EXHIBIT - PHASE 1B

**Architecture**  
A1-0.01 RENDERS  
A1-0.02 RENDERS  
A1-0.03 RENDERS  
A1-0.11 3D VIEWS  
A1-2.21 ENTRY - FLOOR PLAN  
A1-2.33 ENTRY - ROOF PLAN  
A1-3.11 ENTRY - EXTERIOR ELEVATIONS  
A1-3.11 ENTRY-EXTERIOR FINISH LEGEND  
A2-0.01 RENDERS  
A2-0.02 RENDERS  
A2-0.11 3D VIEWS  
A2-2.31 LODGE - FLOOR PLAN  
A2-2.33 LODGE - ROOF PLAN  
A2-3.11 LODGE - EXTERIOR ELEVATIONS  
A2-3.12 EVENT PAVILIONS - EXTERIOR ELEVATIONS  
A2-3.12 LODGE-EXTERIOR FINISH LEGEND  
A3-0.01 GELADA, ANIMAL CARE RENDERS  
A3-0.02 GELADA, ANIMAL CARE RENDERS  
A3-0.11 GELADA, ANIMAL CARE 3D VIEWS  
A3-2.31 GELADA, ANIMAL CARE - FLOOR PLAN  
A3-2.33 GELADA, ANIMAL CARE - ROOF PLAN  
A3-3.11 GELADA, ANIMAL CARE - EXTERIOR ELEVATIONS  
A3-3.12 GELADA, ANIMAL CARE - EXTERIOR FINISH LEGEND

**Exhibits**  
PLANS AND DIAGRAMS  
X010 PHASE 1A SITE PLAN  
X011 PHASE 1A COST ZONES PLAN  
X012 PHASE 1A BUILDING PLAN  
X013 PHASE 1A HABITAT PLAN  
X014 PHASE 1A ZOO ART DIAGRAM  
X015 PHASE 1A PERIMETER FENCE, SERVICE & TRASH PLAN  
X020 PHASE 1B SITE PLAN  
X021 PHASE 1B COST ZONES PLAN  
X022 PHASE 1B BUILDING PLAN  
X023 PHASE 1B HABITAT PLAN  
X030 MASTER SITE PHASING PLAN  
X031 MASTER SITE PLAN  
X032 MASTER BUILDING PLAN  
X033 MASTER HABITAT PLAN  
X034 ANIMAL AND POOL PROGRAM INFORMATION  
X110 PHASE 1A AND 1B OVERALL MATERIALS PLAN AND LEGEND  
X111 MATERIALS PLAN - AREA A  
X112 MATERIALS PLAN - AREA B  
X113 MATERIALS PLAN - AREA C  
X114 MATERIALS PLAN - AREA D  
X120 PHASE 1a AND 1b OVERALL GRADING PLAN AND LEGEND  
X121 GRADING PLAN - AREA A  
X122 GRADING PLAN - AREA B  
X123 GRADING PLAN - AREA C  
X124 GRADING PLAN - AREA D  
X130 OVERALL BARRIERS PLAN AND LEGEND  
X131 BARRIERS DIAGRAM - AREA A  
X132 BARRIERS DIAGRAM - AREA B  
X133 BARRIERS DIAGRAM - AREA C  
X134 BARRIERS DIAGRAM - AREA D  
X140 PHASE 1a AND 1b OVERALL LANDSCAPE STRATEGY PLAN  
X141 LANDSCAPE STRATEGY - AREA A  
X142 LANDSCAPE STRATEGY - AREA B  
X143 LANDSCAPE STRATEGY - AREA C  
X144 LANDSCAPE STRATEGY - AREA D

**LSS**  
LS001 SHEET INDEX, SYMBOLS, ABBREVIATIONS AND NOTES  
LS002 EQUIPMENT SCHEDULES  
LS-SAV-021 SAVANNA HABITAT - PROCESS FLOW DIAGRAM  
LS-FLA-021 FLAMINGO - PROCESS FLOW DIAGRAM  
LS-GEL-021 GELADA - PROCESS FLOW DIAGRAM  
LS-ALL-021 ALLIGATOR - PROCESS FLOW DIAGRAM  
LS101 LSS SITE PLAN  
LS301 ENLARGED LSS PLAN  
LS302 ENLARGED LSS PLAN  
LS303 ENLARGED LSS PLAN  
LS304 ENLARGED LSS PLAN  
LS305 ENLARGED LSS PLAN

**PHASE 1A AND 1B SECTIONS**  
X300 VIEWS FROM LOTZ PARKWAY - PHASE 1  
X301 VIEWS FROM LOTZ PARKWAY - FULL BUILD-OUT  
X310 SECTIONS - ENTRY TO LION  
X311 SECTIONS - GIRAFFE LODGE TO LION  
X312 SECTIONS - SAVANNA WEST VIEW  
X313 SECTIONS - SAVANNA TUNNEL  
X314 SECTIONS - LION  
X315 SECTIONS - MEERKAT  
X316 SECTIONS - FLAMINGO  
X317 SECTIONS - OKAPI, COLOBUS  
X318 SECTIONS - GELADA  
X319 SECTIONS - GELADA AND TORTOISE  
X320 SECTIONS - CHEETAH AND RHINO  
X321 SECTIONS - LEMUR  
X322 SECTIONS - ALLIGATOR AND SQUIRREL MONKEY  
X323 SECTIONS - PLAY  
X324 SECTIONS - GREEN CORRIDOR

**PHASE 1A AND 1B BARRIER SECTIONS**  
X330 BARRIER DETAILS - OKAPI, TORTOISE, LION  
X331 BARRIER DETAILS - SAVANNA  
X332 BARRIER DETAILS - CHEETAH, RHINO, AND ALLIGATOR  
X333 BARRIER DETAILS - GELADA  
X334 BARRIER DETAILS - PERIMETER FENCE

**PHASE 1A AND 1B ARTISTIC LANDSCAPE SKETCH VIEWS**  
X350 MODEL VIEWS  
X351 MODEL VIEWS

**IMAGE BOARDS**  
X401 SITE CHARACTER ZONE PLAN  
X402 IMAGE BOARD - CITY WALK  
X403 IMAGE BOARD - AFRICA  
X404 IMAGE BOARD - GREEN CORRIDOR  
X405 IMAGE BOARD - ARRIVAL PLAZA  
X406 IMAGE BOARD - BEER GARDEN  
X407 IMAGE BOARD - THE PLAY ZONE  
X408 IMAGE BOARD - OKAPI  
X409 IMAGE BOARD - GELADA

**PHASE 1 TIER 2 BUILDINGS AND CARE QUARTERS**  
X701 PHASE 1 CARE QUARTERS PLANS  
X702 PHASE 1 CARE QUARTERS PLANS  
X703 PHASE 1 CARE QUARTERS PLANS  
X704 PHASE 1 CARE QUARTERS PLANS  
X705 PHASE 1 CARE QUARTERS PLANS  
X706 PHASE 1 CARE QUARTERS PLANS  
X707 PHASE 1 CARE QUARTERS PLANS  
X708 PHASE 1 CARE QUARTERS PLANS

### Consultants:

**SHR STUDIOS**  
Jason Hill  
206.842.8332  
jhill@shrstudios.com

**TJP ENGINEERING**  
Terri Johnson  
619.423.8700  
tjohnson@tjpengeering.com

**KIMLEY-HORN**  
Sheetal Bhatt  
916.859.3609  
sheetal.bhatt@kimley-horn.com

**EXP ENGINEERING**  
Walter Brennan  
818.539.1113  
walter.brennan@exp.com

**NOLL AND TAM**  
Janet Tam  
510.542.2212  
janet.tam@nollandtam.com

REV DATE	DESCRIPTION
1	09/22/2023 For Review
2	10/06/2023 For Pricing

NOT FOR CONSTRUCTION

The New Zoo at Elk Grove

COVER SHEET

SHEET SIZE: ARCH E (36" x 48")  
DATE: 06 October 2023  
SCALE: 1/2" = 1'-0"  
CHECKED: SMKM/c  
SHEET:

**G101**

Schematic Plans

NOT DATE TIME

PROPERTY OF SHR STUDIOS. ALL RIGHTS RESERVED. PROJECTS AND PRODUCTS ARE THE PROPERTY OF SHR STUDIOS. ALL RIGHTS RESERVED.





SHR Studios  
250 Madison Way N.E. #220  
Bainbridge Island, WA 98110  
phone (206) 842-8332  
shrstudios.com

**NOLL & TAM**  
ARCHITECTS

Kimley Horn



**1** Phase 1A Site Plan  
1" = 80'-0"

**Site Plan Legend**

- Building
- Exhibit
- Service Area
- Visitor Path
- Water
- Lawn
- Planting Area



REV	DATE	DESCRIPTION
1	09/22/2023	For Review
2	10/06/2023	For Pricing

NOT FOR CONSTRUCTION

The New Zoo at Elk Grove

**PHASE 1A SITE PLAN**

SHEET SIZE:	ARCH E (36" x 48")
DATE:	06 October 2023
SCALE:	As indicated
CHECKED:	SMK/mc
SHEET:	

**X010**

Schematic Plans





2 Phase 1A Cost Zones Plan  
1" = 80'-0"

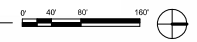

**ZONE 1: ENTRANCE OUTSIDE OF ZOO PERIMETER**

1C: PEDESTRIAN PATH AND DROP-OFF ZONE, RESTAURANT SERVICE ROAD

**ZONE 2: ENTRANCE INSIDE OF ZOO PERIMETER**

2A: ADMINISTRATION / OFFICE BUILDING, RESTROOMS, GUEST SERVICES BUILDING, RETAIL BUILDING, EXHIBIT & CARE QUARTERS, PARKING & SERVICE AREA  
2B: EDUCATION ENTRY & OFFICE, EDUCATION LAWN  
2CA: LODGE (INDOOR & OUTDOOR DINING, BAR, KITCHEN, GAMES LAWN)  
2CB: EVENTS LAWN, PATH TO ZOO, COVERED EVENTS ENTRY, RESTROOMS AND DRESSING ROOMS IN LODGE BUILDING

**ZONE 3: SAVANNA**

3A: SOUTH SAVANNA & RHINO HABITATS & CARE QUARTERS & FILTRATION  
3C: LION HABITAT & CARE QUARTERS  
3D: CHEETAH HABITAT & CARE QUARTERS  
3E: SCREEN PLANTINGS  
3H: OKAPI HABITAT & CARE QUARTERS

**ZONE 4: GREEN CORRIDOR**

4A: MAIN PATHWAY, MONGOOSE HABITAT & CARE QUARTERS, SOUTH PLAY AREA, LAWN, TRAIN STATION, CAROUSEL  
4B: MEERKAT EXHIBIT & CARE QUARTERS  
4C: FLAMINGO EXHIBIT, CARE QUARTERS & FILTRATION

**ZONE 4: GREEN CORRIDOR**

4F: LAWN  
4G: CANOPY PLAY, THICK BILLED PARROT NETTED ENCLOSURE & CARE QUARTERS  
4H: LAWN  
4J: ANIMAL CARE CENTER & GUEST PAVILION, OFF EXHIBIT ANIMAL CARE, SERVICE YARD  
4K: GELADA CAFÉ KITCHEN, ORDER & PICKUP COUNTER & OUTDOOR SEATING, RESTROOMS  
4LA: GELADA EXHIBIT, CARE QUARTERS, FILTRATION & CLASSROOMS  
4LB: MULTIPURPOSE ROOMS, DECK AND PARKING

**ZONE 5: PERIMETER SERVICE ROAD**

5A: WEST SERVICE ROAD  
5B: SERVICE ROAD, MAINTENANCE BUILDING AND GARBAGE COLLECTION  
5C: EAST SERVICE ROAD

REV	DATE	DESCRIPTION
1	09/22/2023	For Review
2	10/06/2023	For Pricing

NOT FOR CONSTRUCTION

The New Zoo at Elk Grove

PHASE 1A COST ZONES PLAN

SHEET SIZE: ARCH E (36" x 48")  
DATE: 06 October 2023  
SCALE: 1" = 80'-0"  
CHECKED: SMK/mc  
SHEET:

**X011**

Schematic Plans

NOT DATE TIME: 10/06/2023 10:27 AM

PROPERTY OF SHR STUDIOS, INC. USE OF THIS DOCUMENT FOR ANY OTHER PROJECT WITHOUT THE WRITTEN PERMISSION IS STRICTLY PROHIBITED.



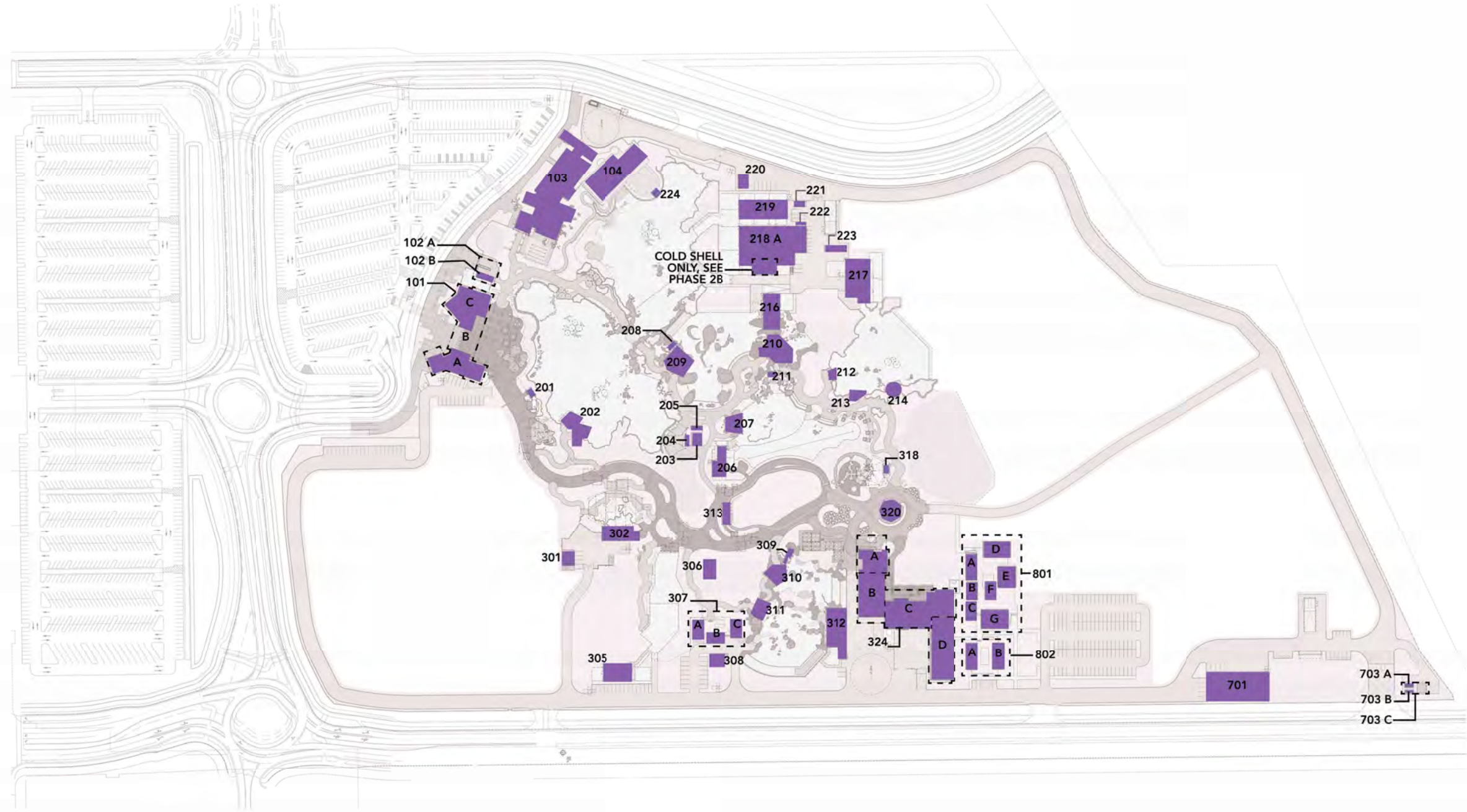

1 Phase 1A Building Plan  
1" = 80'-0"

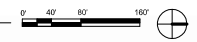

#	Building Name	Size (sf)	#	Building Name	Size (sf)	#	Building Name	Size (sf)	#	Building Name	Size (sf)
101 A	Guest Services/Restrooms/Ticketing	4,700	208	Fennec Fox Care Quarters	300	223	Event Lawn Giraffe Feeding Shelter	150	801 G	Admin Modular 6	2,500
101 B	Breezeway	3,900	209	Lion View Shelter 1	2,600	302	Flamingo Care Quarters/Brooder	2,200	802 A	Animal Staff Modular 1	1,800
101 C	Retail	5,900	210	Lion View Shelter 2	4,600	305	Okapi Care Quarters	2,200	802 B	Animal Staff Modular 2	1,800
102 A	Education Entry Canopy	2,500	211	Meerkat Care Quarters	150	306	Giant Tortoise Care Quarters	1,100			
102 B	Education Entry Restrooms	500	212	Rhino View Shelter 1	420	307 A	Multipurpose Room	1,000			
103	The Lodge (interior)	12,000	213	Rhino View Shelter 2	720	307 B	Multipurpose Room	1,000			
103	The Lodge (exterior)	3,000	214	Rhino Encounter Shelter	900	307 C	Multipurpose Room	1,000			
201	Dwarf Mongoose Care Quarters	200	216	Lion Care Quarters	3,200	308	Gelada LSS	550			
202 A	Giraffe Feeding Shelter Canopy	2,200	217	Rhino Care Quarters	4,400	309	Klipspringer/Hyax Holding	430			
202 B	Giraffe Feeding Shelter Sales Room	150	218 A	Giraffe Care Quarters	11,500	310	Gelada View Shelter 2	1,500			
203	Beer Garden Restrooms	800	219	Hoofstock Care Quarters	4,200	311	Gelada View Shelter 1	1,300			
204	Beer Service	250	220	Savanna LSS	3,800	312	Gelada Care Quarters	4,500			
205	Beer Service	250	221	Walk In Browse Cooler	200	313	Train Depot	1,100			
206	Cheetah Care Quarters	1,800	222	Containerized Fodder System	8 ft x 20 ft	318	Parrot Care Quarters	250			
207	Cheetah View Shelter	1,400	222	Hay Storage	500	320	Carousel Pavilion	1,500			

REV	DATE	DESCRIPTION
1	09/22/2023	For Review
2	10/06/2023	For Pricing

NOT FOR CONSTRUCTION

The New Zoo at Elk Grove

PHASE 1A BUILDING PLAN

SHEET SIZE: ARCH E (36" x 48")  
DATE: 06 October 2023  
SCALE: 1" = 80'-0"  
CHECKED: SMK/mc  
SHEET:

X012

Schematic Plans





















2 Phase 1B Cost Zones Plan  
1" = 80'-0"



**ZONE 2: ENTRANCE INSIDE OF ZOO PERIMETER**  
2CB: EVENTS PAVILION

**ZONE 3: SAVANNA**  
3E: GUEST OVERNIGHT ACCOMMODATIONS  
3H: IMPROVEMENTS TO OKAPI PADDOCK (ADDITION OF EARTH BANK PLANTERS), MULTISPECIES HABITAT (NETTED ENCLOSURE) FOR OKAPI & AFRICA BIRDS, AFRICA BIRDS CARE QUARTERS, COLOBUS HABITAT (NETTED ENCLOSURE) AND CARE QUARTERS

**ZONE 4: GREEN CORRIDOR**  
4E: ALLIGATOR HABITAT, CARE QUARTERS & LSS; SQUIRREL MONKEY HABITAT & CARE QUARTERS  
4F: TORTOISE HABITAT & CARE QUARTERS  
4G: CANOPY PLAY FAMILY RESTROOMS  
4H: LEMUR HABITATS (2 NETTED ENCLOSURES) & CARE QUARTERS

REV DATE	DESCRIPTION
1 09/22/2023	For Review
2 10/06/2023	For Pricing

NOT FOR CONSTRUCTION

The New Zoo at Elk Grove

PHASE 1B COST ZONES PLAN

SHEET SIZE: ARCH E (36" x 48")  
DATE: 06 October 2023  
SCALE: 1" = 80'-0"  
CHECKED: SMK/Mc  
SHEET:

**X021**

Schematic Plans























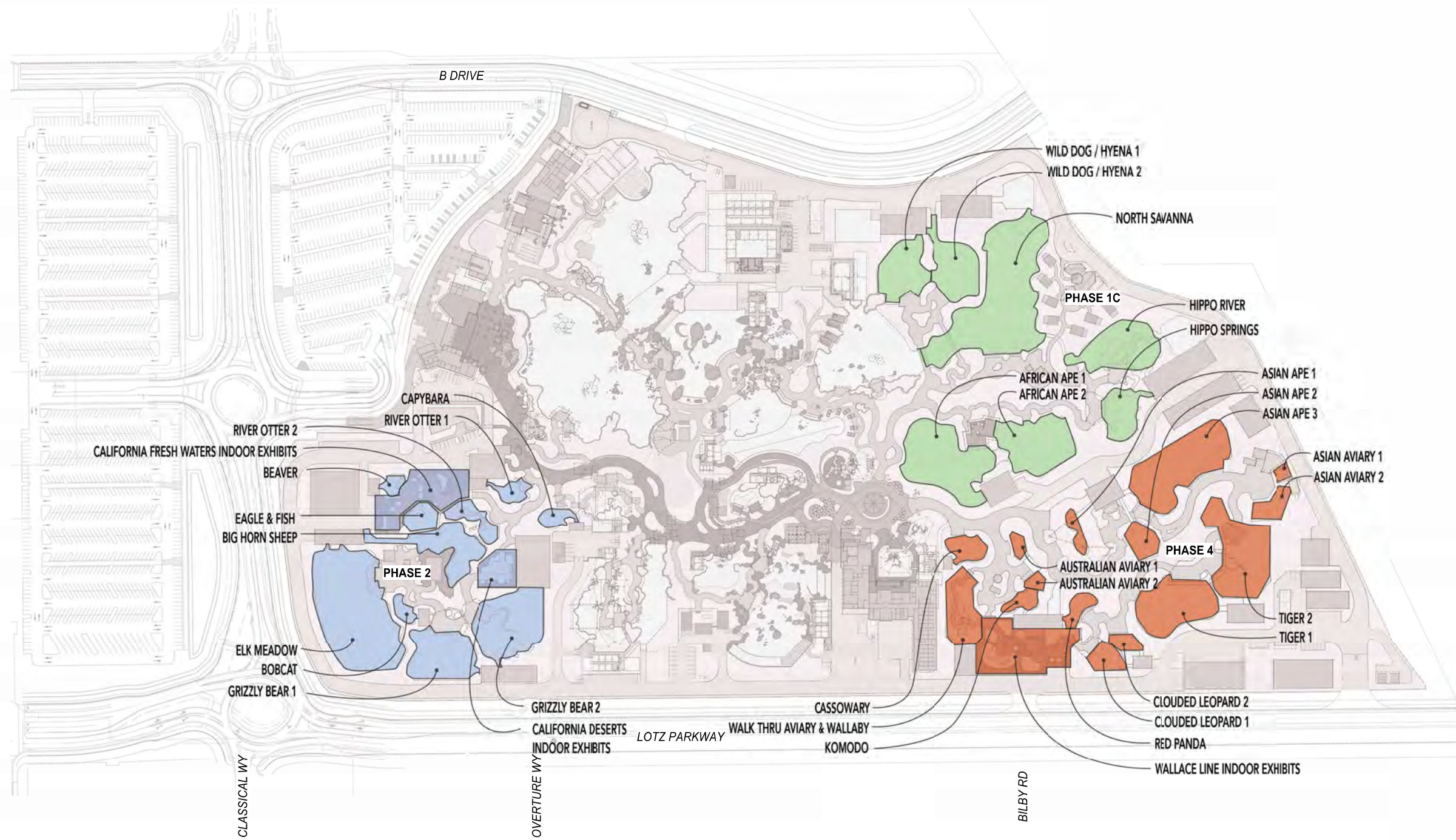

REV DATE	DESCRIPTION
1 09/22/2023	For Review
2 10/06/2023	For Pricing

1 Master Habitat Plan  
1" = 80'-0"



- Master Habitat Plan Legend**
- PH 1C Habitats
  - PH 3 Habitats - California
  - PH 4 Habitats - Australasia

\*\* See Sheet 1/X034 for Animal and Pool Program

NOT FOR CONSTRUCTION

The New Zoo at Elk Grove

MASTER HABITAT PLAN

SHEET SIZE:	ARCH E (36" x 48")
DATE:	06 October 2023
SCALE:	As indicated
CHECKED:	SMK/mc
SHEET:	

**X033**

Schematic Plans

NOT DATE TIME 10/10/2023 11:28:10 AM

PROPERTY OF SHR STUDIOS, INC. USE OF THIS DOCUMENT WITHOUT WRITTEN PERMISSION IS STRICTLY PROHIBITED.



Animal Program

Phase 1A	
<b>Dwarf Mongoose</b>	
Habitat Size (sf):	215 sf
Species (numbers):	Dwarf Mongoose (#?) Rock Hyrax (#?)
<b>Savanna East &amp; West</b>	
Habitat Size (sf):	Savanna West: 52,330 sf Savanna East: 73,575 sf Creep: 5,150 sf Total Savanna:
Species (numbers):	Small antelope (0.0.12) Medium Antelope (0.0.9) Common Eland (1.2.0) Ostrich (0.0.4) Giraffe (2.18.0) Grey Crowned Crane (0.0.4) Zebra (1.3.0)
<b>Lion</b>	
Habitat Size (sf):	Lion 1: 16,340 sf Lion 2: 6,000 sf Total Lion:
Species (numbers):	Lion (1.3.8)
<b>Cheetah</b>	
Habitat Size (sf):	15,230 sf
Cheetah Run Length (ft)	300 ft
Cheetah Run Width (ft)	22 ft
Species (numbers):	Cheetah (#?)
<b>Fennec Fox</b>	
Habitat Size (sf):	430 sf
Species (numbers):	TBD
<b>Meerkat</b>	
Habitat Size (sf):	Meerkat 1: 1,000 sf Meerkat 2: 600 sf Total:
Species (numbers):	Meerkat (#?)
<b>Rhino</b>	
Habitat Size (sf):	28,380 sf
Species (numbers):	White Rhino (1.3.2)
<b>Flamingo Aviary and Flighted Birds</b>	
Habitat Size (sf):	8615 sf
Species (numbers):	Flamingo (#?)
<b>Okapi</b>	
Habitat Size (sf):	Okapi 1a: 4,925 sf Okapi 1b: 7,220 sf Total: 12,145 sf
Species (numbers):	Black Crowned Crane (1.1.0)
<b>Gelada + Hyrax</b>	
Habitat Size (sf):	Gelada 1: 15,500 sf Gelada 2: 8,500 sf Total: 24,000 sf
Species (numbers):	Gelada (0.0.30) Kilpspringer (1.1.0) Hyrax (0.0.6)
<b>Thick Billed Parrot</b>	
Habitat Size (sf):	Habitat 1: 1,290 sf Habitat 2: 1,185 sf
Species (numbers):	Thick Billed Parrot

Phase 1B (Add Alternates)	
<b>Africa Aviary: Okapi &amp; Birds</b>	
Habitat Size (sf)	Aviary and Okapi accessible area: 14,300 sf Okapi accessible area: 7,400 sf
Species (numbers):	Okapi (1.1.1) Black Crowned Crane (1.1.0) Vulturine Guinea Fowl (#?) Turaco (#?) Bee Eaters (#?)
<b>Africa Aviary: Primates</b>	
Habitat Size (sf):	Colobus 1: 2,560 sf
Species (numbers):	Colobus (1.3.2) Guenon (1.3.2)
<b>Giant Tortoise</b>	
Habitat Size (sf):	6,820 sf
Species (numbers):	Giant Tortoise (#?)
<b>Alligator</b>	
Habitat Size (sf):	2,500 sf
Species (numbers):	North American Alligator (#?)
<b>Squirrel Monkey</b>	
Habitat Size (sf):	2,190 sf
Species (numbers):	Squirrel Monkey (#?)
<b>Lemur</b>	
Habitat Size:	Lemur 1: 2,800 sf Lemur 2: 2,200 sf
Species (numbers):	Lemur (#?)

Future Africa	
<b>Wild Dog/Hyena</b>	
Habitat Size:	Hyena 1: 12,000 sf Hyena 2: 12,500 sf Wild Dog (0.0.5) Hyena (#)
Species (numbers):	
<b>North Savanna</b>	
Habitat Size:	45,500 sf
Species (numbers):	Ostrich (0.0.4) White Rhino (1.3.2) Zebra (1.3.0)
<b>African Ape</b>	
Habitat Size:	Ape 1: 24,000 sf Ape 2: 17,000 sf
Species (numbers):	TBD
<b>Hippo</b>	
Habitat Size:	Hippo 1 (Hippo Springs Habitat): 7,980 sf Hippo 2 (Hippo River Habitat): 16,490 sf Hippo Encounter: 760 sf
Species (numbers):	Hippopotamus (1.6.0)

Future California	
<b>Beaver</b>	
Habitat Size:	2,070 sf
Species (numbers):	American Beaver (#?)
<b>Big Horn Sheep</b>	
Habitat Size:	12,670 sf
Species (numbers):	Big Horn Sheep (#?)
<b>Bobcat</b>	
Habitat Size:	2,135 sf
Species (numbers):	Bobcat (#?)
<b>California Deserts Interior Exhibits</b>	
Habitat Size:	Total Building: 6,410sf Area 1: 100 sf Area 2: 100 sf Area 3: 355 sf Area 4: 50 sf Area 5: 50 sf Area 6: 55 sf Area 7: 340 sf Area 8: 600 sf
Species (numbers):	TBD
<b>California Fresh Waters Interior Exhibits</b>	
Habitat Size:	Total Building: 16,535 sf Area 1: 80 sf Area 2: 115 sf Area 3: 120 sf Area 4: 155 sf Area 5: 315 sf Area 6: 80 sf Area 7: 55 sf Area 8: 145 sf Area 9: 135 sf
Species (numbers):	TBD
<b>Capybara</b>	
Habitat Size:	2,855 sf
Species (numbers):	Capybara (#?)
<b>Eagle &amp; Fish</b>	
Habitat Size:	3,960 sf
Species (numbers):	TBD
<b>Elk Meadow</b>	
Habitat Size:	41,975 sf
Species (numbers):	North American Elk (#?)
<b>Grizzly Bear</b>	
Habitat Size:	Grizzly Bear 1: 15,435 sf Grizzly Bear 2: 20,610 sf
Species (numbers):	North American Brown Bear (#?)
<b>River Otters</b>	
Habitat Size:	River Otter 1: 3,050 sf River Otter 2: 5,265 sf
Species (numbers):	North American River Otter (#?)
<b>Sturgeon</b>	
Habitat Size:	490 sf in California Fresh Waters Building
Species (numbers):	Sturgeon (#?)
<b>TBD California Sierra Nevada Mountains Exhibits</b>	
Habitat Size:	Area 1: 110 sf Area 2: 165 sf Area 3: 170 sf
Species (numbers):	TBD

Future Australasia	
<b>Australia Avia-ries</b>	
Habitat Size:	Aviary 1: 1,650 sf Aviary 2: 1,340
Species (numbers):	TBD
<b>Cassowary</b>	
Habitat Size:	4,480 sf
Species (numbers):	Cassowary (#?)
<b>Aviary &amp; Wallaby</b>	
Habitat Size:	11,190 sf
Species (numbers):	TBD
<b>Komodo Dragon</b>	
Habitat Size:	Total Building: 2,745 sf
Species (numbers):	TBD
<b>Fish in Play Area</b>	
Habitat Size:	10 sf
Species (numbers):	TBD
<b>Wallace Line Gallery</b>	
Habitat Size:	Total building: 22,435 sf Little Blue Penguin: 2,795 sf Komodo Dragon: 915 sf Australian Reptile 1: 770 sf Australia Reptile 2: 145 sf Australia Reptile 3: 440 sf Red Panda: 1,770 sf Asian Reptile 1: 1,130 sf Asian Reptile 2: 130 sf Asian Reptile 3: 130 sf Asian Reptile 4: 30 sf
Species (numbers):	TBD
<b>Asian Ape</b>	
Habitat Size:	Asian Ape 1: 2,350 sf Asian Ape 2: 4,995 sf Asian Ape 3: 24,640 sf
Species (numbers):	TBD
<b>Asia Avia-ries</b>	
Habitat Size:	Aviary 1: 1,230 sf Aviary 2: 4,250 sf
Species (numbers):	Hornbill (#?) Pheasant (#?)
<b>Blood Python</b>	
Habitat Size:	170 sf
Species (numbers):	Blood Python (#?)
<b>Clouded Leopard</b>	
Habitat Size:	Clouded Leopard 1: 4,125 sf Clouded Leopard 2: 2,455 sf
Species (numbers):	Clouded Leopard (1.1.1)
<b>Red Panda</b>	
Habitat Size:	3,105 sf
Species (numbers):	Red Panda (#?)
<b>Tiger</b>	
Habitat Size:	Tiger 1: 17,690 sf Tiger 2: 19,930 sf
Species (numbers):	Tiger (#?)

Pool Program

	Filtered?	Salt or Fresh	Avg. Depth	Max. Depth	Surface Area	Volume	Surface Elevation	Heated Temp. Range	Cooled Temp. Range	Fish?	
<b>Base Phase Pools</b>											
<b>Savanna 1 &amp; 2</b>											
1.1.1	Water Hole	Yes	Fresh	4.63 ft	8 ft	3,600 gal	125,800 gal	34	No Heat	NA	No
<b>Flamingo Aviary</b>											
1.2.1	Flamingo Habitat Pool	Yes	Fresh	2 ft	4 ft	1,580 sf	24,900 gal	38	No Heat	NA	No
1.2.2	Flamingo Holding Pool in Care Quarters	Yes	Fresh	1.5 ft	3 ft	400 sf	4,500 gal	36	No Heat	NA	No
<b>Gelada</b>											
1.3.1	Gelada Moat Barrier	Yes	Fresh	1.92 ft	4 ft	2370 sf	35,900 gal	35	No Heat	NA	No
1.3.2	Gelada Upper Pool	Yes	Fresh	3.21 ft	4 ft	2092 sf	51,900 gal	35	No Heat	NA	No
1.3.3	Gelada Lower Pool	Yes	Fresh	1 ft	1 ft	830 sf	6,300 gal	33	No Heat	NA	No
<b>Aviary Pools - Add Alternative Pools</b>											
<b>Alligator</b>											
2.1.1	Alligator Habitat Pool	Yes	Fresh	3 ft	5 ft	1,010 sf	22,700 gal	36	45-50 degrees	NA	No
2.1.2	Alligator Holding Pool in Care Quarters	Yes	Fresh	2 ft	2 ft	195 sf	3,900 gal	37	45-50 degrees	NA	No
<b>Tortoise</b>											
2.2.1	Tortoise Habitat Pool	No	Fresh	1 ft	1 ft	100 sf	1,800 gal	36.5	No Heat	NA	No
2.2.2	Tortoise Holding Pool in Care Quarters	No	Fresh	1 ft	1 ft	45 sf	340 gal	38.5	No Heat	NA	No
2.2.3	Tortoise Holding Pool in Care Quarters	No	Fresh	1 ft	1 ft	45 sf	340 gal	38.5	No Heat	NA	No
<b>Okapi</b>											
2.3.1	Okapi Aviary Pool	No	Fresh	1 ft	2 ft	90 sf	680 gal	39.5	No Heat	NA	No



Sacramento Zoological Society  
3800 W. Land Park Drive  
Sacramento, CA USA



SHR Studios  
250 Madison Way N.E. #220  
Bainbridge Island, WA 98110  
phone (206) 843-8332  
shrstudios.com

**NOLL & TAM**  
ARCHITECTS

Kimley-Horn



REV	DATE	DESCRIPTION
1	09/22/2023	For Review
2	10/06/2023	For Pricing

NOT FOR CONSTRUCTION

The New Zoo at Elk Grove

ANIMAL AND POOL PROGRAM INFORMATION

SHEET SIZE: ARCH E (36" x 48")  
DATE: 06 October 2023  
SCALE: 1" = 100'-0"  
CHECKED: SMK/Mc  
SHEET:

X034

Schematic Plans



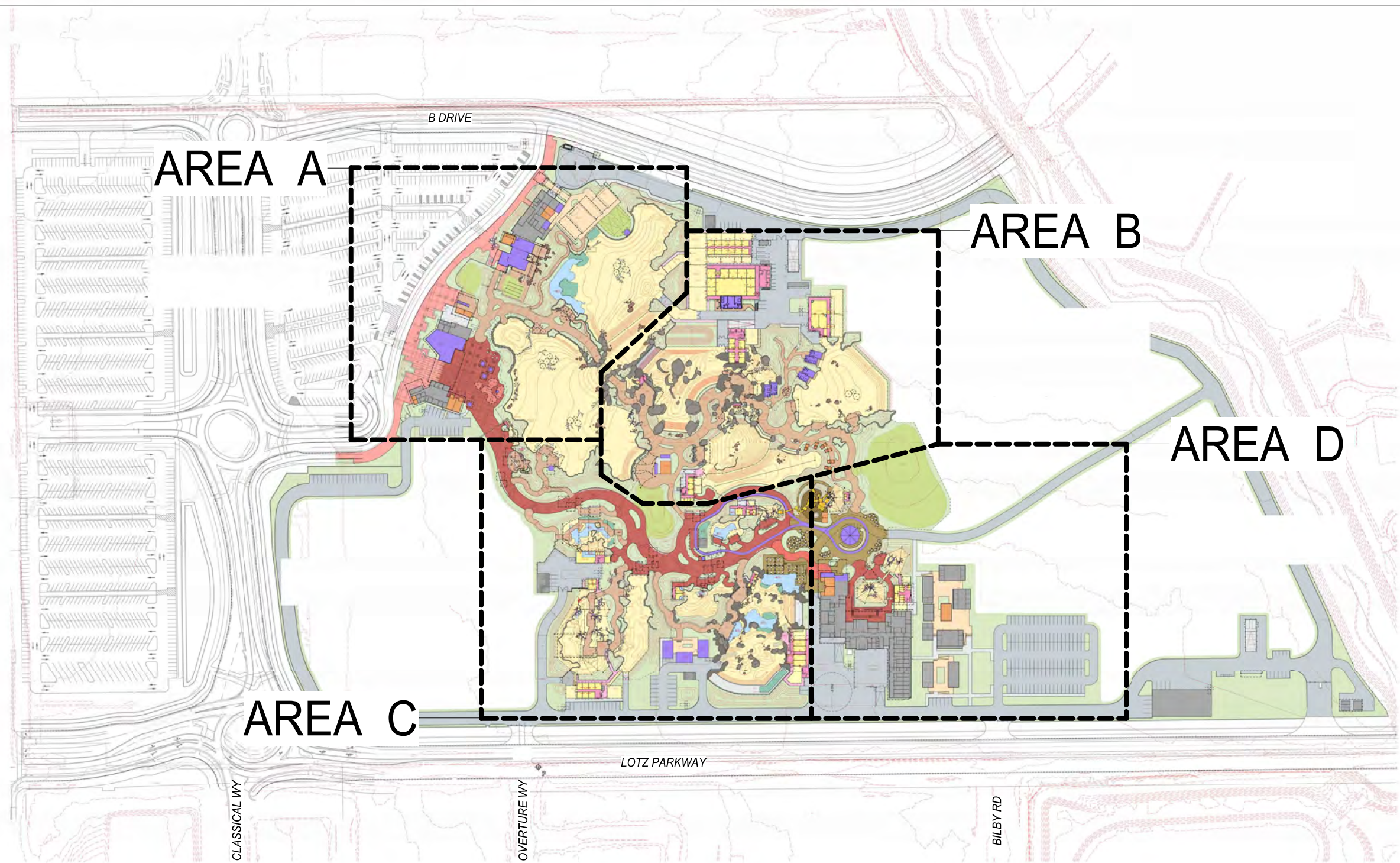

1 Phase 1a and 1b Overall Materials Key Plan  
1" = 80'-0"

Materials Plan Legend

Fencing and Barriers (see diagram):	Paving Types:	Paving Types:	Symbols:	Symbols:
Zoo Perimeter Wall	Asphalt	Integral Colored Concrete Paving w/ Broom Finish	Water	Shotcrete Wall - Graded Mud Bank
Animal Barrier	Typical Concrete Paving w/Broom Finish	Exterior Animal Area - Substrates Vary Per Animal Program	Lawn	Shotcrete Wall - Boulder/Kopje Texture
Guest Barrier	Integral Colored Concrete Paving w/ Broom Finish and Artistic Joint Pattern	Interior Animal Area - Substrates Vary Per Animal Program	Shrubs and Trees	Natural Boulders
Reed Barrier	Integral Colored Concrete Paving w/ Broom Finish	Exterior Keeper Area - Typ. Sealed Concrete w/ Broom Finish	Building - See Arch for Tier 1 and LSS Plans	Artificial Deadfall/Branches
Roof Edge Above	Integral Colored Concrete Paving w/ Broom finish	Interior Keeper Area - Typ. Sealed Concrete w/ Broom Finish	Revenue Opportunities	Natural Deadfall/Branches
Water Edge	Rubber Play Surface	Filtration Support Wetland	Restrooms	Gate
Mesh				C/P Site Wall/Sculptural Element
				Shade Canopy
				Tree Grate
				Cafe Table and Chairs with Umbrella
				Cheetah Habitat 'Jeep' Seating (Open-Sided Safari Jeep w/4 Rows of Seating and Canopy, non functioning)
				Playground Climbing Element

REV DATE	DESCRIPTION
1 09/22/2023	For Review
2 10/06/2023	For Pricing

NOT FOR CONSTRUCTION

The New Zoo at Elk Grove

PHASE 1A AND 1B  
OVERALL MATERIALS  
PLAN AND LEGEND

SHEET SIZE:	ARCH E (36" x 48")
DATE:	06 October 2023
SCALE:	As indicated
CHECKED:	SMK/Mc
SHEET:	

X110

Schematic Plans



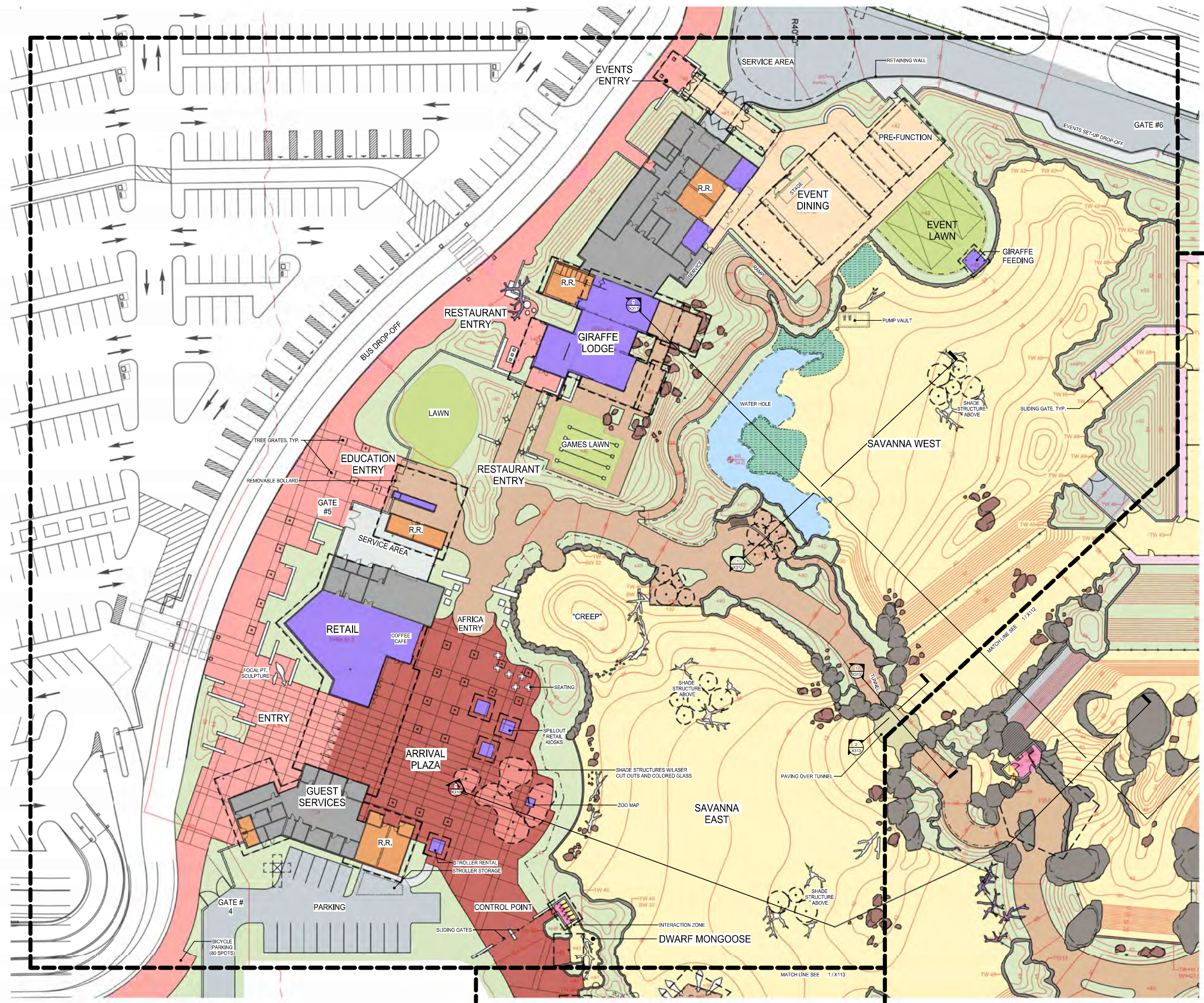

Sacramento Zoological Society  
3500 W. Land Park Drive  
Sacramento, CA USA



SHR Studios  
250 Madison Way N.E. #220  
Bainbridge Island, WA 98110  
phone (206) 842-8332  
shrstudios.com

**NOLL & TAM**  
ARCHITECTS

Kimley **Horn**



exp.

REV. DATE	DESCRIPTION
1 09/22/2023	For Review
2 10/06/2023	For Pricing

NOT FOR CONSTRUCTION

The New Zoo at Elk Grove

MATERIALS PLAN - AREA A

SHEET SIZE: ARCH E (36" x 48")  
DATE: 06 October 2023  
SCALE: 1" = 20'-0"  
CHECKED: SMK/mc  
SHEET:

**X111**

Schematic Plans

1 Materials Plan - Area A  
1" = 20'-0"



PROPERTY OF SHR STUDIOS, INC. USE OF THIS DOCUMENT IS PROHIBITED WITHOUT THE WRITTEN CONSENT OF SHR STUDIOS, INC.







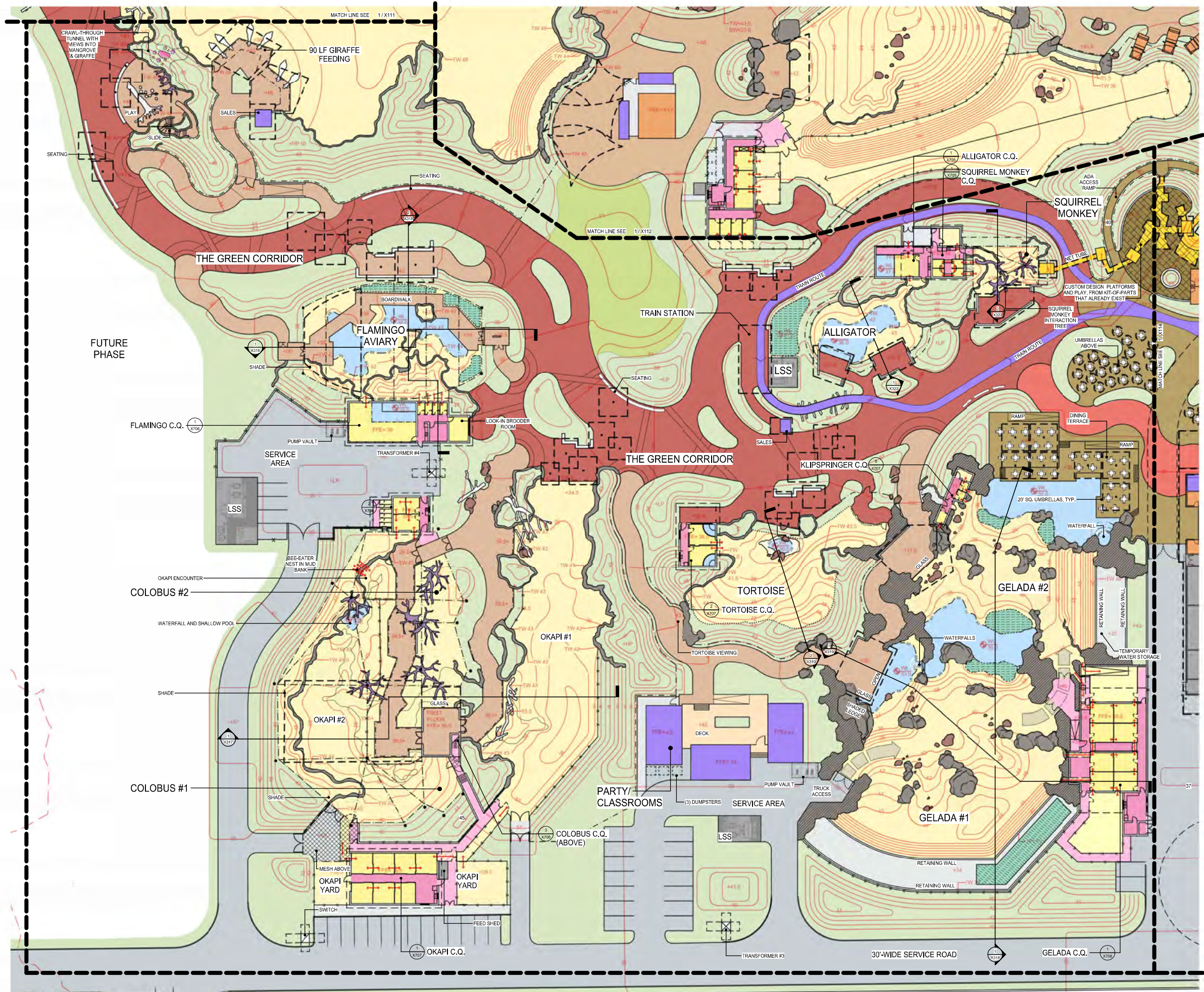

REV. DATE	DESCRIPTION
1 09/22/2023	For Review
2 10/06/2023	For Pricing

NOT FOR CONSTRUCTION

The New Zoo at Elk Grove

MATERIALS PLAN - AREA C

SHEET SIZE: ARCH E (36" x 48")  
DATE: 06 October 2023  
SCALE: 1" = 20'-0"  
CHECKED: SMK/mc  
SHEET:

**X113**

Schematic Plans

1 Materials Plan - Area C  
1" = 20'-0"

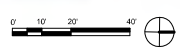

NOT DATE TIME: 10/06/2023 11:28 AM

PROPERTY OF SHR STUDIOS, INC. USE OF THIS DOCUMENT IS PROHIBITED WITHOUT WRITTEN PERMISSION. ALL RIGHTS RESERVED.



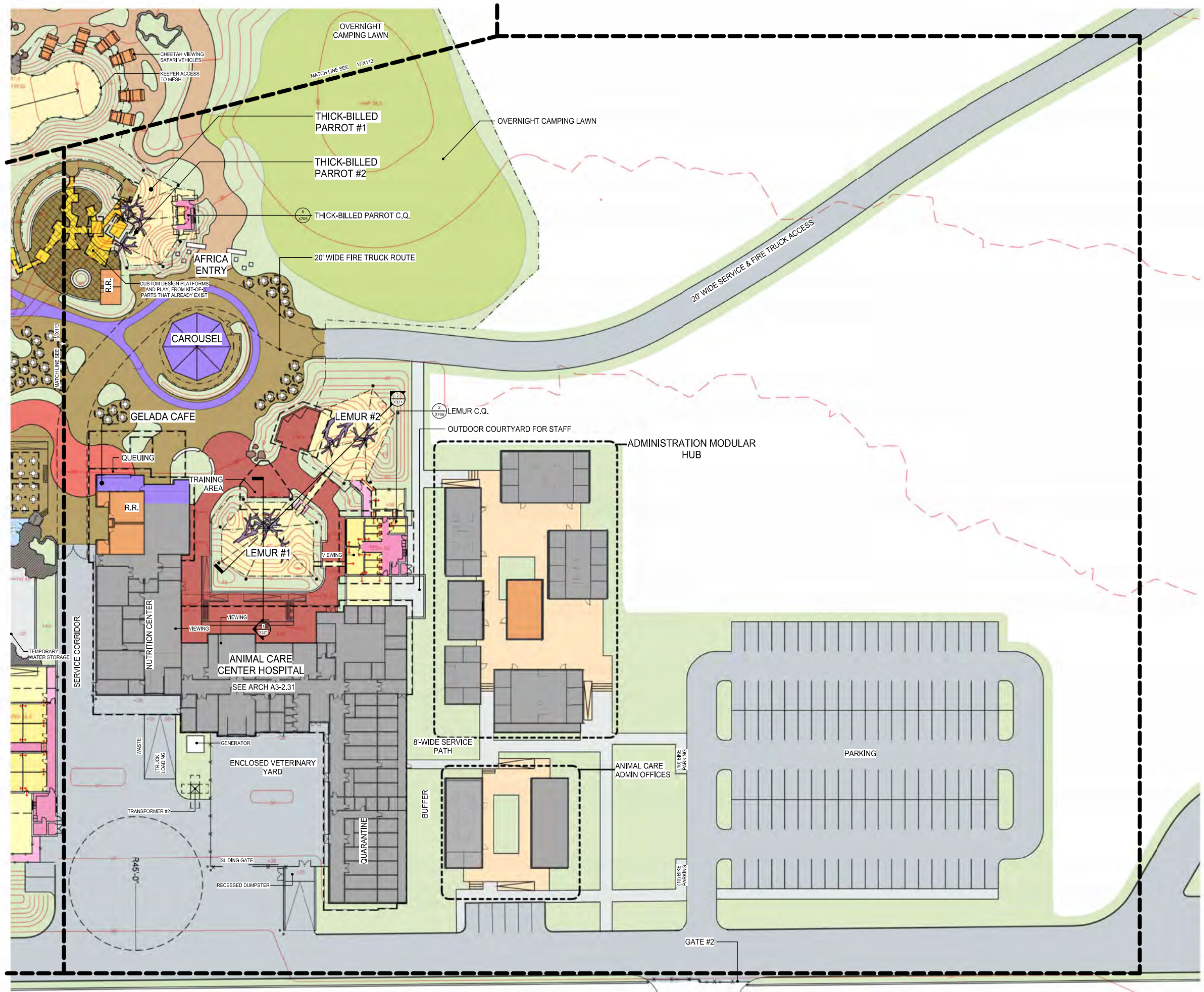

REV	DATE	DESCRIPTION
1	09/22/2023	For Review
2	10/06/2023	For Pricing

NOT FOR CONSTRUCTION

The New Zoo at Elk Grove

MATERIALS PLAN - AREA D

SHEET SIZE: ARCH E (36" x 48")  
DATE: 06 October 2023  
SCALE: 1" = 20'-0"  
CHECKED: SMK/mc  
SHEET:

**X114**

Schematic Plans

1 Materials Plan - Area D  
1" = 20'-0"

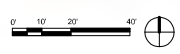

NOT DATE TIME: 10/06/2023 10:00 AM

PROPERTY OF SHR STUDIOS, INC. USE OF THIS DOCUMENT IS PROHIBITED WITHOUT THE WRITTEN CONSENT OF SHR STUDIOS, INC.













Sacramento Zoological Society  
3920 W. Land Park Drive  
Sacramento, CA USA



SHR Studios  
250 Madison Way N.E. #220  
Bainbridge Island, WA 98110  
phone (206) 842 8332  
shrstudios.com

NOLL  
& TAM  
ARCHITECTS

Kimley Horn



REV	DATE	DESCRIPTION
1	09/22/2023	For Review
2	10/06/2023	For Pricing

NOT FOR CONSTRUCTION

The New Zoo at Elk Grove

GRADING PLAN - AREA B

SHEET SIZE: ARCH E (36" x 48")  
DATE: 06 October 2023  
SCALE: 1" = 20'-0"  
CHECKED: SMK/mc  
SHEET:

X122

Schematic Plans

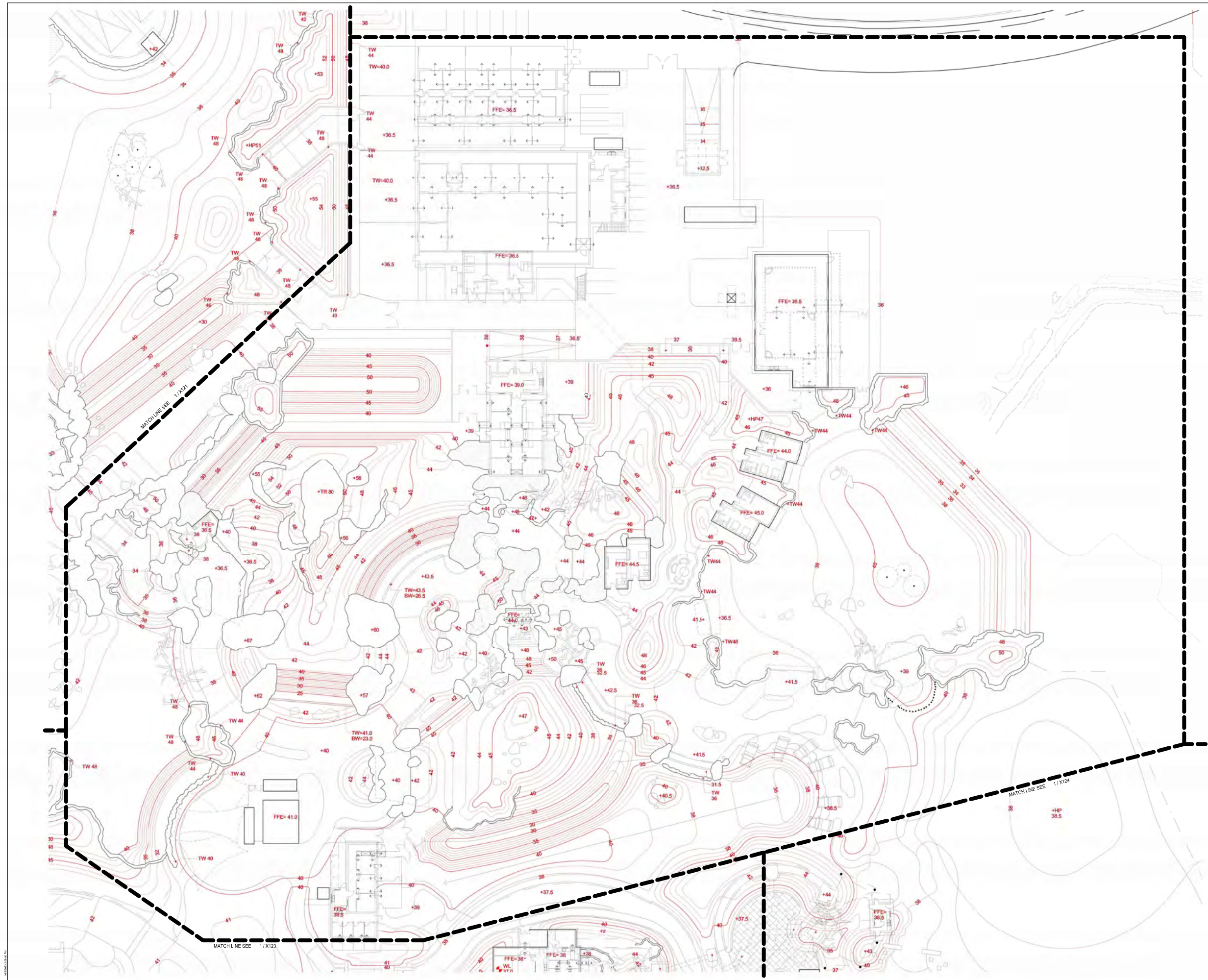

















Sacramento Zoological Society  
3500 W. Land Park Drive  
Sacramento, CA USA



SHR Studios  
250 Madison Way N.E. #220  
Bainbridge Island, WA 98110  
phone (206) 842-8332  
shrstudios.com

**NOLL & TAM**  
ARCHITECTS

Kimley **Horn**



exp.

REV DATE	DESCRIPTION
1 09/22/2023	For Review
2 10/06/2023	For Pricing

NOT FOR CONSTRUCTION

The New Zoo at Elk Grove

BARRIERS DIAGRAM - AREA A

SHEET SIZE: ARCH E (36" x 48")  
DATE: 06 October 2023  
SCALE: 1" = 20'-0"  
CHECKED: SMK/ML  
SHEET:

X131

Schematic Plans

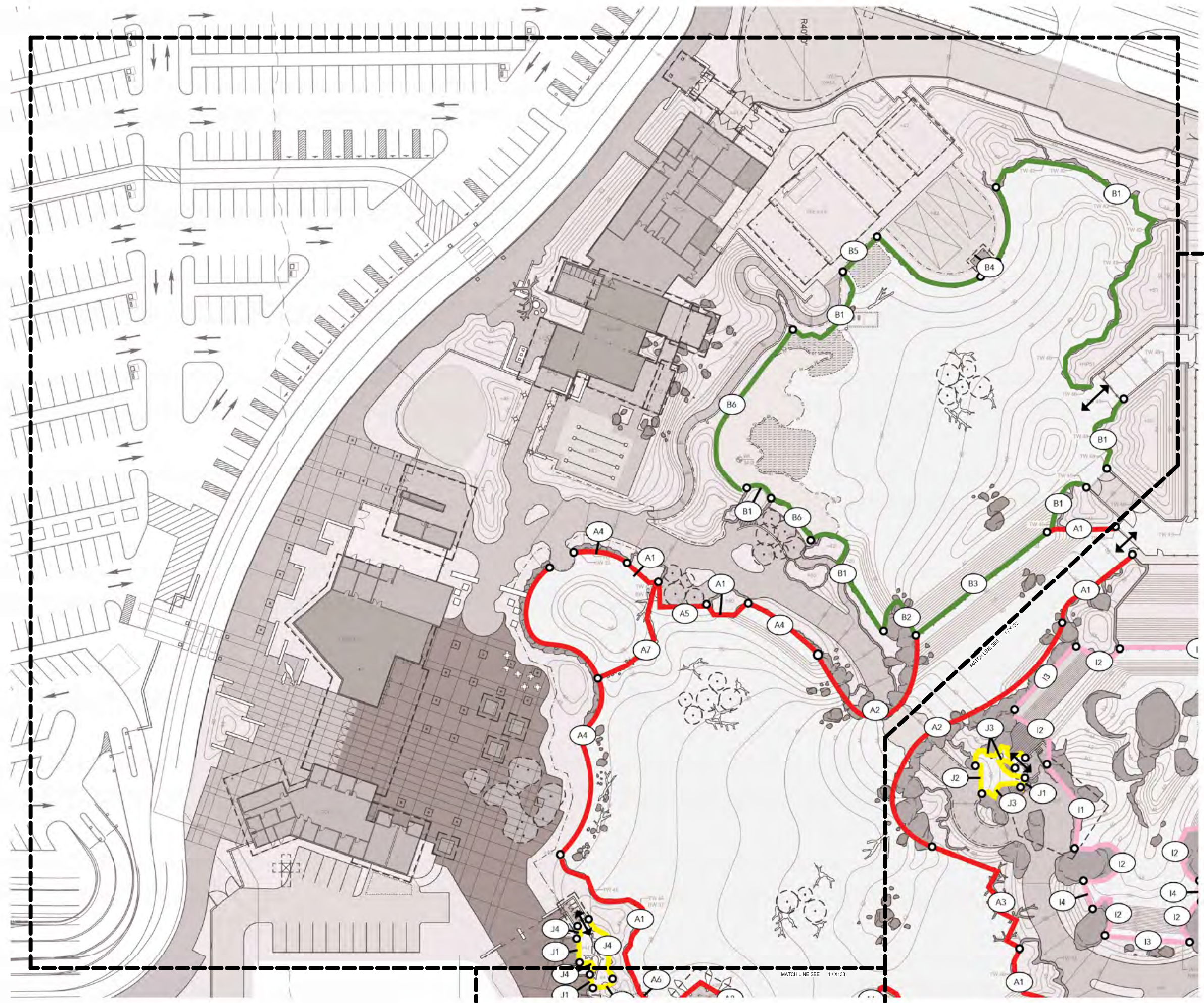

1 Barriers Diagram - Area A  
1" = 20'-0"

NOT DATE TIME: 10/06/2023 10:00 AM

PROPERTY OF SHR STUDIOS, INC. USE OF THIS DOCUMENT WITHOUT WRITTEN PERMISSION IS STRICTLY PROHIBITED. ALL RIGHTS RESERVED.





REV	DATE	DESCRIPTION
1	09/22/2023	For Review
2	10/06/2023	For Pricing

NOT FOR CONSTRUCTION

The New Zoo at Elk Grove

BARRIERS DIAGRAM - AREA B

SHEET SIZE: ARCH E (36" x 48")  
DATE: 06 October 2023  
SCALE: 1" = 20'-0"  
CHECKED: SMK/mc  
SHEET:

**X132**

Schematic Plans

1 Barriers Diagram - Area B  
1" = 20'-0"

NOT DATE TIME: 10/06/2023 10:11:11 AM

PROPERTY OF SHR STUDIOS, INC. USE OF THIS DOCUMENT FOR ANY OTHER PROJECT WITHOUT THE WRITTEN CONSENT OF SHR STUDIOS IS STRICTLY PROHIBITED.



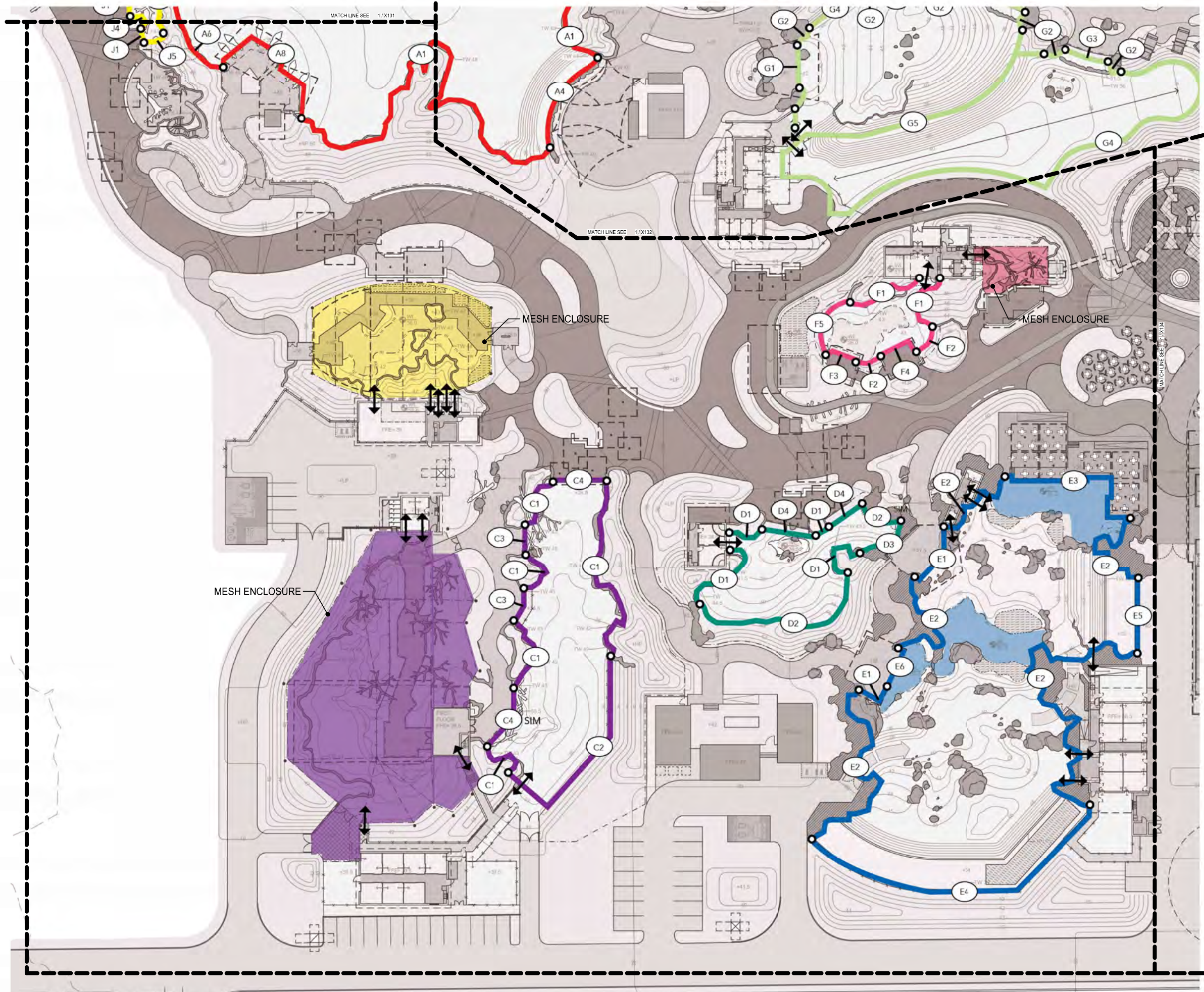

REV DATE	DESCRIPTION
1 09/22/2023	For Review
2 10/06/2023	For Pricing

NOT FOR CONSTRUCTION

The New Zoo at Elk Grove

BARRIERS DIAGRAM - AREA C

SHEET SIZE: ARCH E (36" x 48")  
DATE: 06 October 2023  
SCALE: 1" = 20'-0"  
CHECKED: SMK/mc  
SHEET:

**X133**

Schematic Plans

1 Barriers Diagram - Area C  
1" = 20'-0"

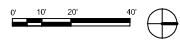

NOT DATE TIME: 10/06/2023 10:20 AM

PROPERTY OF SHR STUDIOS, INC. USE OF THIS DOCUMENT WITHOUT THE WRITTEN CONSENT OF SHR STUDIOS IS PROHIBITED.





Sacramento Zoological Society  
3500 W. Land Park Drive  
Sacramento, CA USA



SHR Studios  
250 Madonna Way N.E. #220  
Bainbridge Island, WA 98110  
phone (206) 842-8332  
shrstudios.com

**NOLL & TAM**  
ARCHITECTS

Kimley **Horn**



REV	DATE	DESCRIPTION
1	09/22/2023	For Review
2	10/06/2023	For Pricing

NOT FOR CONSTRUCTION

The New Zoo at Elk Grove

BARRIERS DIAGRAM - AREA D

SHEET SIZE: ARCH E (36" x 48")  
DATE: 06 October 2023  
SCALE: 1" = 20'-0"  
CHECKED: SMK/Mc  
SHEET:

**X134**

Schematic Plans

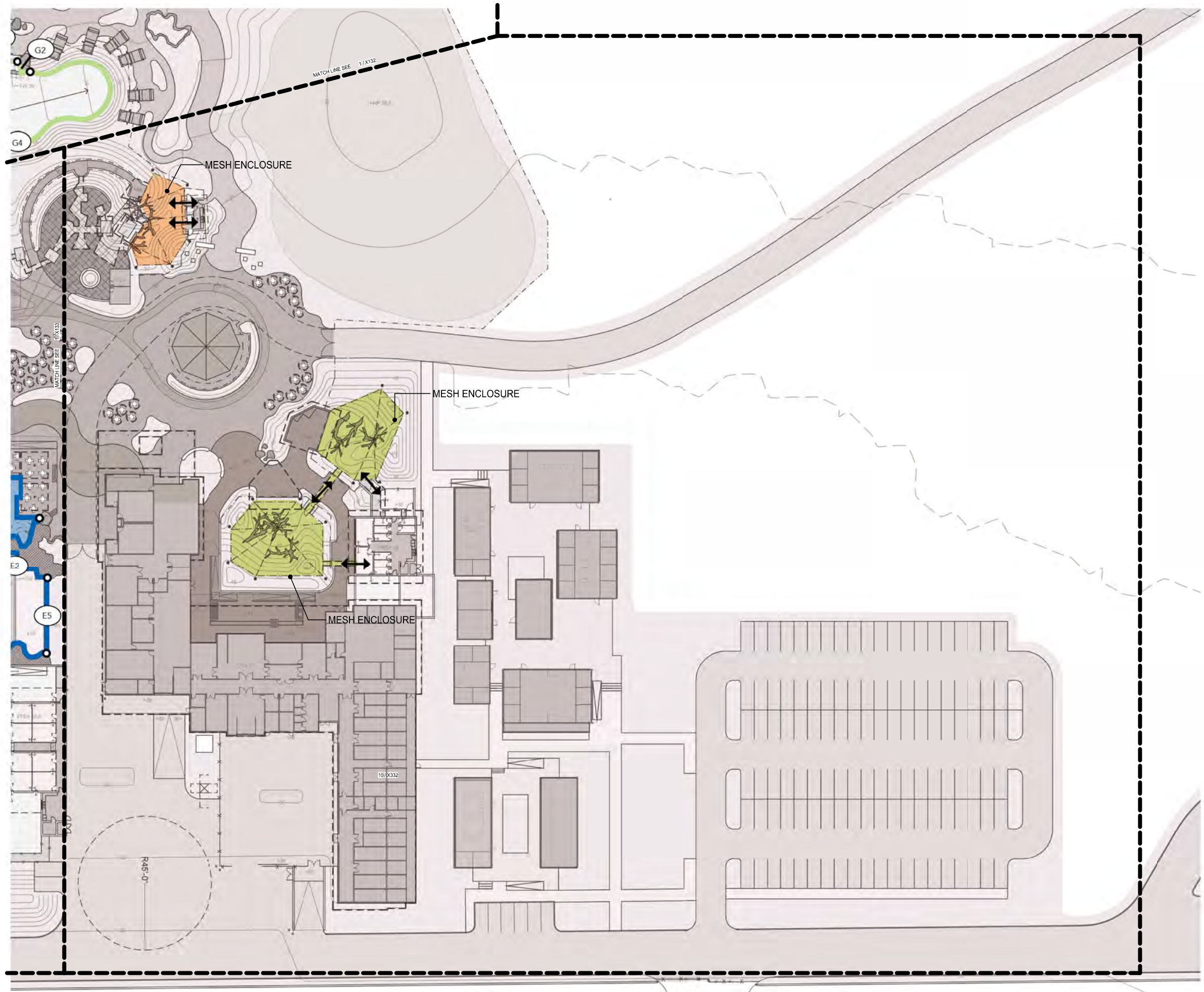

1 Barriers Diagram - Area D  
1" = 20'-0"

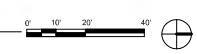

NOT DATE TIME: 10/06/2023 10:00 AM

PROPERTY OF SHR STUDIOS, INC. USE OF THIS DOCUMENT WITHOUT THE WRITTEN CONSENT OF SHR STUDIOS IS STRICTLY PROHIBITED.









Sacramento Zoological Society  
3500 W. Land Park Drive  
Sacramento, CA USA



SHR Studios  
250 Madison Way N.E. #220  
Bainbridge Island, WA 98110  
phone (206) 842-8332  
shrstudios.com

**NOLL & TAM**  
ARCHITECTS

Kimley **Horn**



exp.

REV	DATE	DESCRIPTION
1	09/22/2023	For Review
2	10/06/2023	For Pricing

NOT FOR CONSTRUCTION

The New Zoo at Elk Grove

LANDSCAPE STRATEGY - AREA A

SHEET SIZE: ARCH E (36" x 48")  
DATE: 06 October 2023  
SCALE: 1" = 20'-0"  
CHECKED: SMK/ML  
SHEET:

**X141**

Schematic Plans

1 Landscape and Irrigation Plan - Area A  
1" = 20'-0"

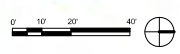

PROPERTY OF SHR STUDIOS, INC. USE OF THIS DOCUMENT IS PROHIBITED WITHOUT THE WRITTEN CONSENT OF SHR STUDIOS, INC.





Sacramento Zoological Society  
3830 W. Land Park Drive  
Sacramento, CA USA



SHR Studios  
250 Madison Way N.E. #220  
Bainbridge Island, WA 98110  
phone (206) 842-8332  
shrstudios.com

**NOLL & TAM**  
ARCHITECTS

Kimley **Horn**



exp.

REV	DATE	DESCRIPTION
1	09/22/2023	For Review
2	10/06/2023	For Pricing

NOT FOR CONSTRUCTION

The New Zoo at Elk Grove

LANDSCAPE STRATEGY - AREA B

SHEET SIZE: ARCH E (36" x 48")  
DATE: 06 October 2023  
SCALE: 1" = 20'-0"  
CHECKED: SMK/ML  
SHEET:

**X142**

Schematic Plans

1 Landscape and Irrigation Plan - Area B  
1" = 20'-0"

NOT DATE TIME

PROPERTY OF SHR STUDIOS, INC. USE OF THIS DOCUMENT IS PROHIBITED WITHOUT THE WRITTEN CONSENT OF SHR STUDIOS, INC.



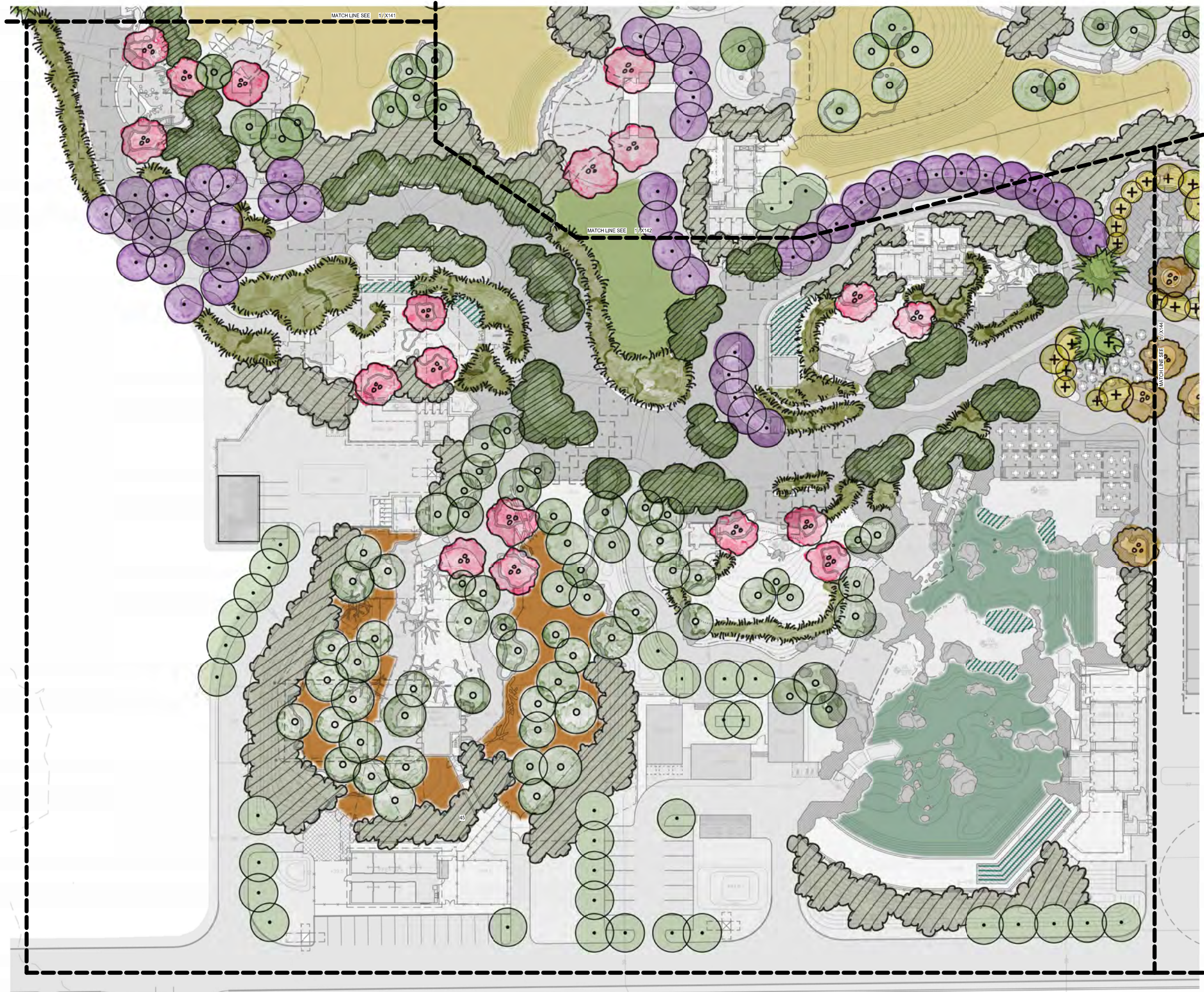

Sacramento Zoological Society  
3800 W. Land Park Drive  
Sacramento, CA USA



SH R Studios  
250 Madison Way N.E. #220  
Bainbridge Island, WA 98110  
phone (206) 842-8332  
shrstudios.com

**NOLL & TAM**  
ARCHITECTS

Kimley **Horn**



exp.

REV	DATE	DESCRIPTION
1	09/22/2023	For Review
2	10/06/2023	For Pricing

NOT FOR CONSTRUCTION

The New Zoo at Elk Grove

LANDSCAPE STRATEGY - AREA C

SHEET SIZE: ARCH E (36" x 48")  
DATE: 06 October 2023  
SCALE: 1" = 20'-0"  
CHECKED: SMK/ML  
SHEET:

**X143**

Schematic Plans

1 Landscape and Irrigation Plan - Area C  
1" = 20'-0"



PROPERTY OF SHR STUDIOS, INC. USE OF THIS DOCUMENT FOR ANY OTHER PROJECT WITHOUT THE EXPRESSED WRITTEN PERMISSION IS STRICTLY PROHIBITED.





Sacramento Zoological Society  
3500 W. Land Park Drive  
Sacramento, CA USA



SHR Studios  
250 Madison Way N.E. #220  
Bainbridge Island, WA 98110  
phone (206) 842-8332  
shrstudios.com

**NOLL & TAM**  
ARCHITECTS

Kimley **Horn**



exp.

REV	DATE	DESCRIPTION
1	09/22/2023	For Review
2	10/06/2023	For Pricing

NOT FOR CONSTRUCTION

The New Zoo at Elk Grove

LANDSCAPE STRATEGY - AREA D

SHEET SIZE: ARCH E (36" x 48")  
DATE: 06 October 2023  
SCALE: 1" = 20'-0"  
CHECKED: SMK/Mc  
SHEET:

**X144**

Schematic Plans

1 Landscape and Irrigation Plan - Area D  
1" = 20'-0"

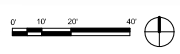

NOT DATE TIME: 10/06/2023 10:00 AM

PROPERTY OF SHR STUDIOS, INC. USE OF THIS DOCUMENT WITHOUT THE WRITTEN CONSENT OF SHR STUDIOS, INC. IS PROHIBITED.





BIRDSEYE VIEW LOOKING SOUTH



STREET-LEVEL VIEW LOOKING SOUTH



BIRDSEYE VIEW LOOKING NORTH



STREET-LEVEL VIEW LOOKING NORTH



Sacramento Zoological Society  
3500 W. Land Park Drive  
Sacramento, CA USA



SH R Studios  
250 Madison Way N.E. #220  
Bainbridge Island, WA 98110  
phone (206) 842-8332  
shrstudios.com



Kimley **Horn**



REV DATE	DESCRIPTION
1 09/22/2023	For Review
2 10/06/2023	For Pricing

NOT FOR CONSTRUCTION

The New Zoo at Elk Grove

VIEWS FROM LOTZ PARKWAY - PHASE 1

SHEET SIZE: ARCH E (36" x 48")  
DATE: 06 October 2023  
SCALE: 1" = 1'-0"  
CHECKED: SMK/mc  
SHEET:

X300

Schematic Plans

NOT DATE TIME 10/06/2023 10:00 AM

PROPERTY OF SHR STUDIOS INC. USE OF THIS DOCUMENT PROHIBITED WITHOUT WRITTEN CONSENT FROM SHR STUDIOS INC. ALL RIGHTS RESERVED.







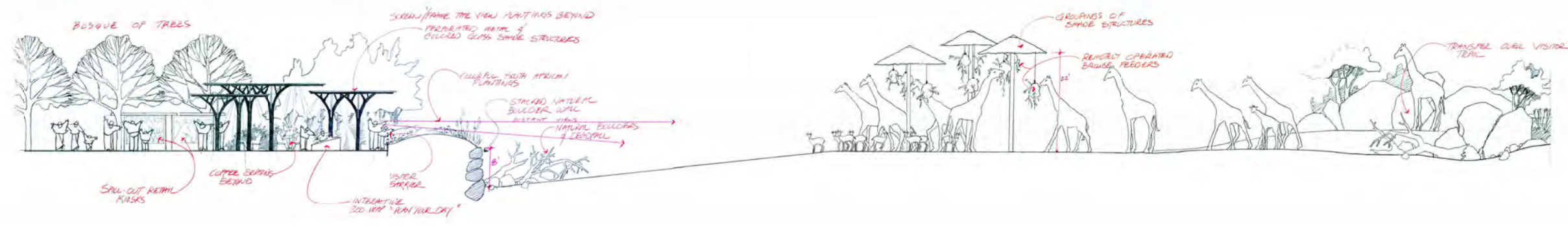

1 Entry to Lion - Section  
1/8" = 1'-0"

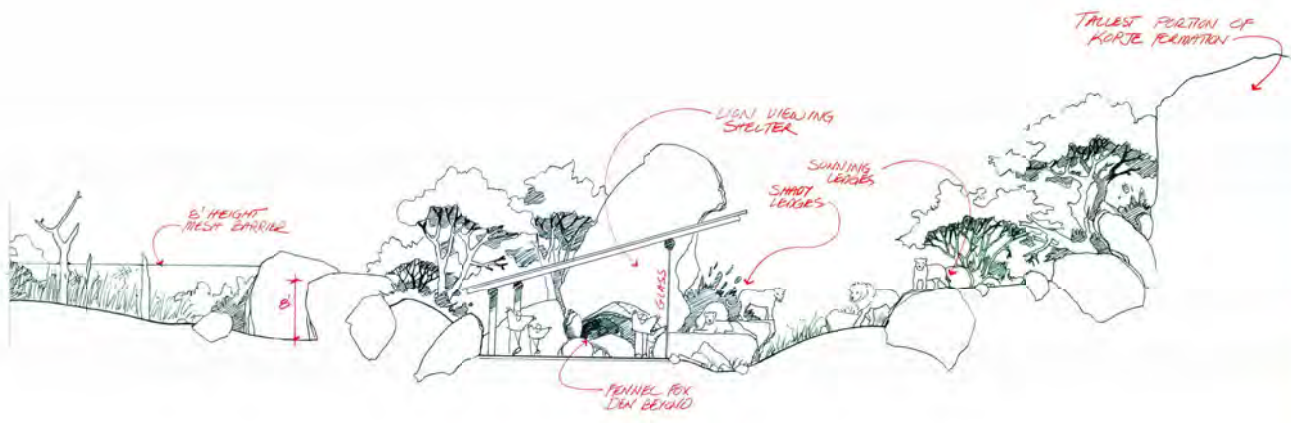

Entry to Lion Continued- Section  
1/8" = 1'-0"

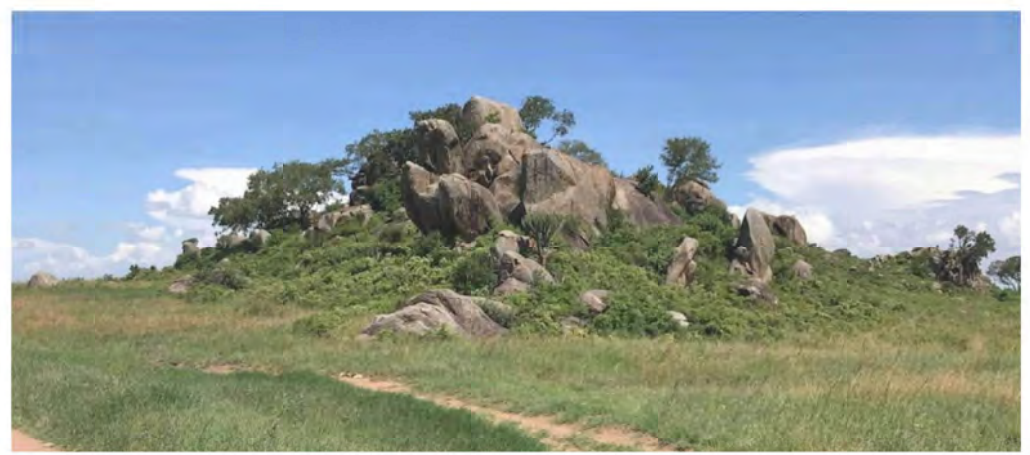

REV DATE	DESCRIPTION
1 09/22/2023	For Review
2 10/06/2023	For Pricing

NOT FOR CONSTRUCTION

The New Zoo at Elk Grove

SECTIONS - ENTRY TO LION

SHEET SIZE: ARCH E (36" x 48")  
DATE: 06 October 2023  
SCALE: As indicated  
CHECKED: SMK/ML  
SHEET:

**X310**

Schematic Plans



REV	DATE	DESCRIPTION
1	09/22/2023	For Review
2	10/06/2023	For Pricing

NOT FOR CONSTRUCTION

The New Zoo at Elk Grove

SECTIONS - GIRAFFE LODGE TO LION

SHEET SIZE: ARCH E (36" x 48")  
DATE: 06 October 2023  
SCALE: 1/8" = 1'-0"  
CHECKED: SMK/ML  
SHEET:

**X311**

Schematic Plans



1 Giraffe Lodge to Lion - Section  
1/8" = 1'-0"



Giraffe Lodge to Lion Continued - Section  
1/8" = 1'-0"

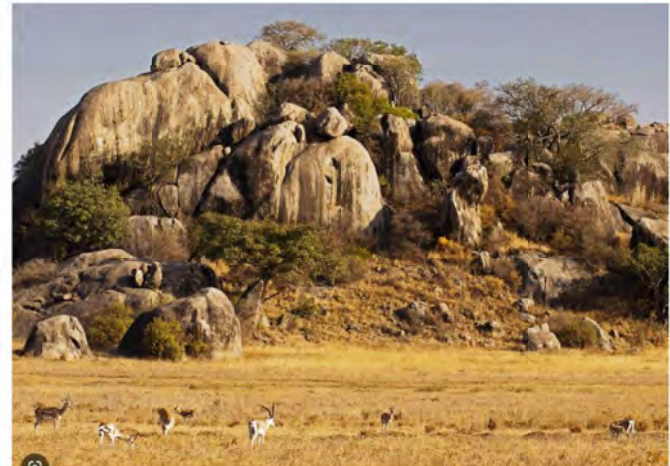



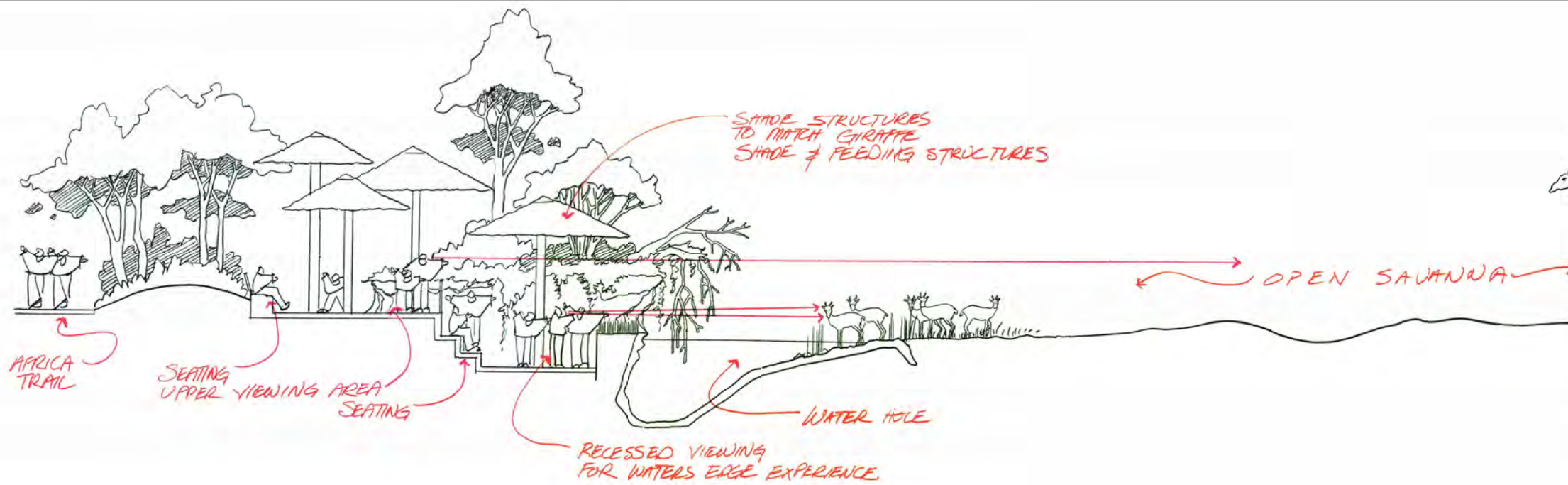

1 Savanna West View - Section  
1/4" = 1'-0"

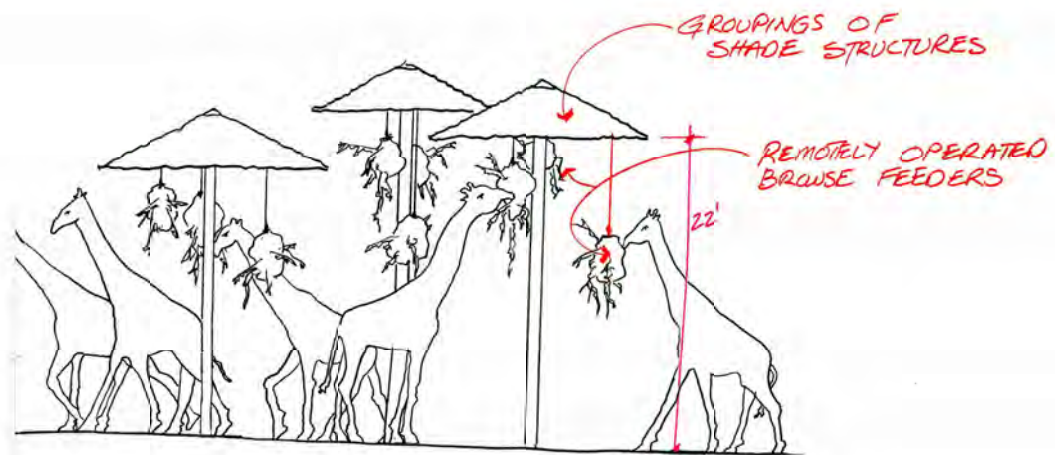

Savanna West View - Section Continued  
1/4" = 1'-0"



REV DATE	DESCRIPTION
1 09/22/2023	For Review
2 10/06/2023	For Pricing

NOT FOR CONSTRUCTION

The New Zoo at Elk Grove

SECTIONS - SAVANNA  
WEST VIEW

SHEET SIZE:	ARCH E (36" x 48")
DATE:	06 October 2023
SCALE:	As indicated
CHECKED:	SMK/Mc
SHEET:	

X312

Schematic Plans



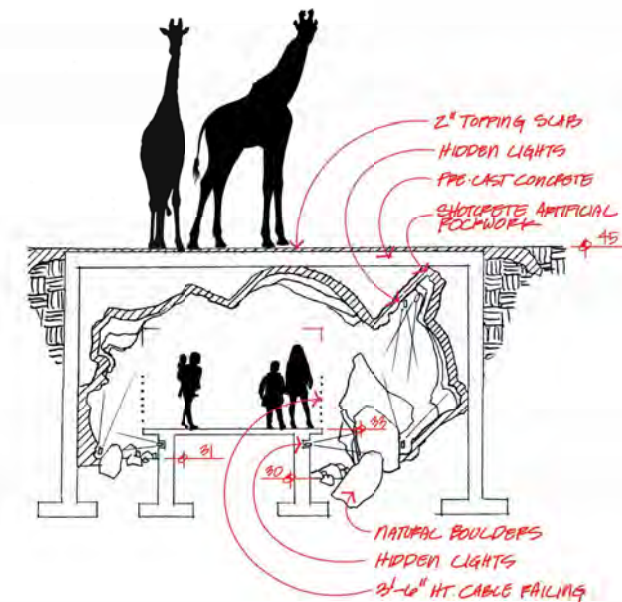
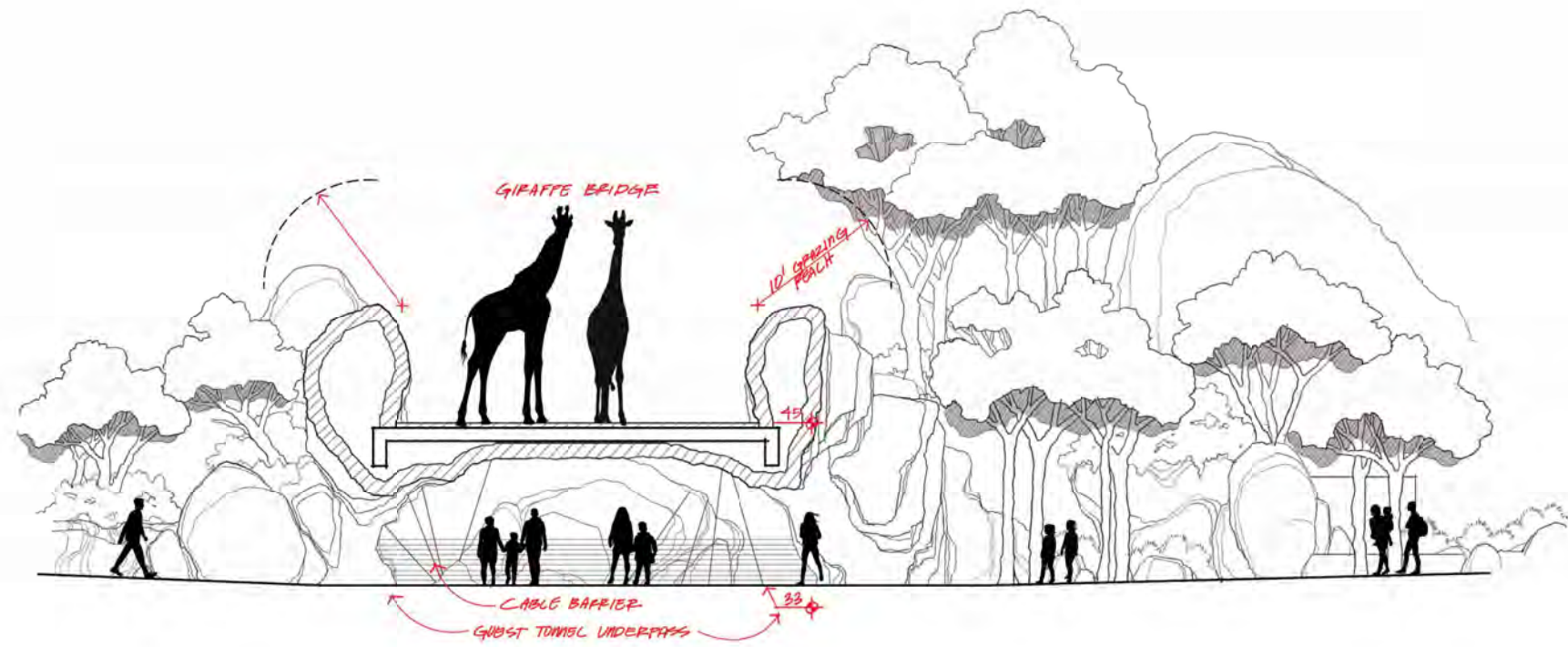

1 Savanna Animal Bridge North South - Section  
1/4" = 1'-0"

2 Savanna Tunnel - Section  
1/4" = 1'-0"

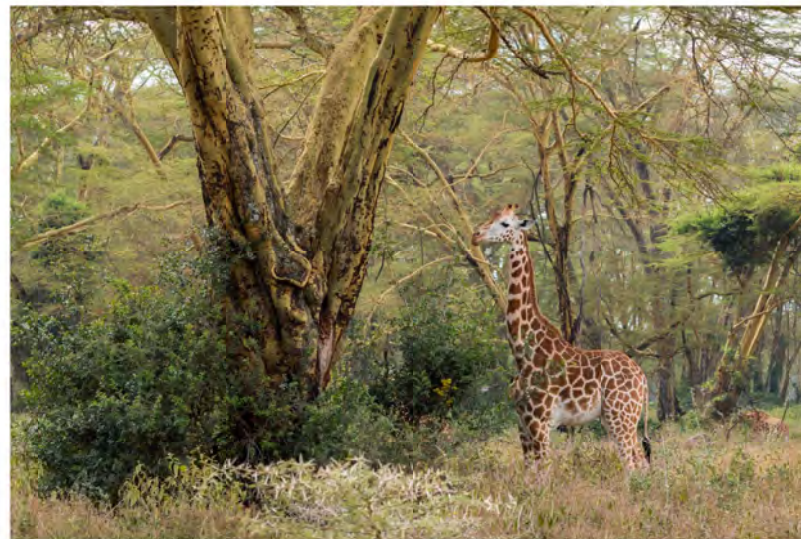

Sacramento Zoological Society  
3500 W. Land Park Drive  
Sacramento, CA USA



SH R Studios  
250 Madison Way N.E. #220  
Bainbridge Island, WA 98110  
phone (206) 842-8332  
shrstudios.com



REV	DATE	DESCRIPTION
1	09/22/2023	For Review
2	10/06/2023	For Pricing

NOT FOR CONSTRUCTION

The New Zoo at Elk Grove

SECTIONS - SAVANNA TUNNEL

SHEET SIZE: ARCH E (36" x 48")  
DATE: 06 October 2023  
SCALE: As indicated  
CHECKED: SMK/mc  
SHEET:

X313

Schematic Plans

NOT DATE TIME

PROPERTY OF SHR STUDIOS, INC. USE OF PHOTOGRAPHS PROVIDED BY PHOTO PROVIDER. ALL RIGHTS RESERVED.



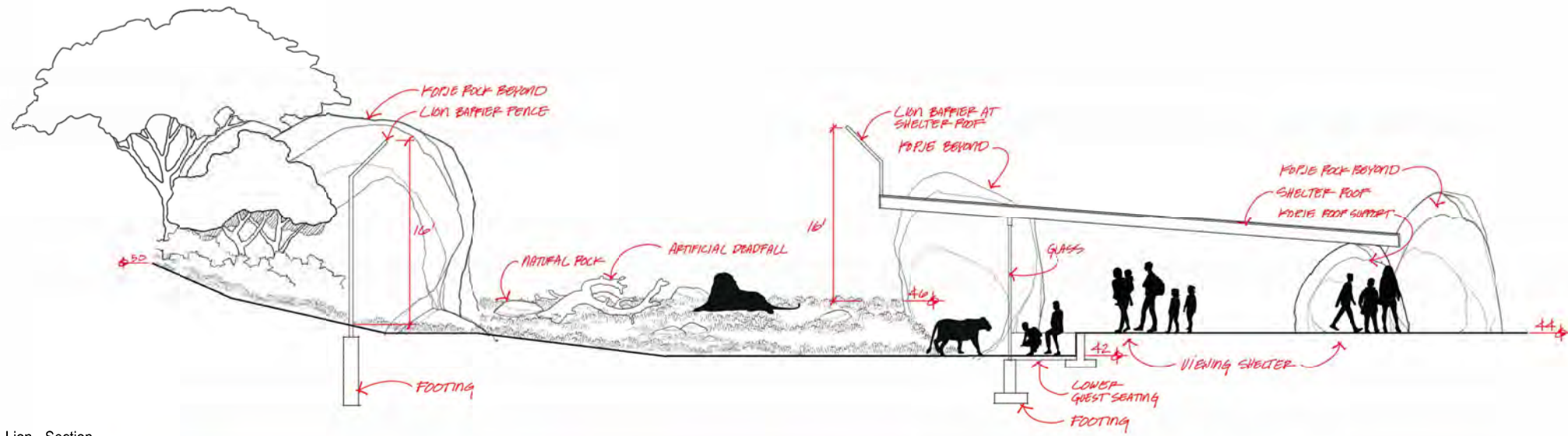

1 Lion - Section  
1/4" = 1'-0"



Sacramento Zoological Society  
3800 W. Land Park Drive  
Sacramento, CA USA



SHR Studios  
250 Madison Way N.E. #220  
Burlington, VT 05401  
phone (205) 842-8332  
shrstudios.com



REV	DATE	DESCRIPTION
1	09/22/2023	For Review
2	10/06/2023	For Pricing

NOT FOR CONSTRUCTION

The New Zoo at Elk Grove

SECTIONS - LION

SHEET SIZE: ARCH E (36" x 48")  
DATE: 06 October 2023  
SCALE: As indicated  
CHECKED: SMK/MLC  
SHEET:

X314

Schematic Plans

PROPERTY OF SHR STUDIOS, INC. USE OF PHOTOGRAPHS PROVIDED BY PHOTOGRAPHERS IS SOLELY FOR ILLUSTRATION PURPOSES. ALL RIGHTS RESERVED.



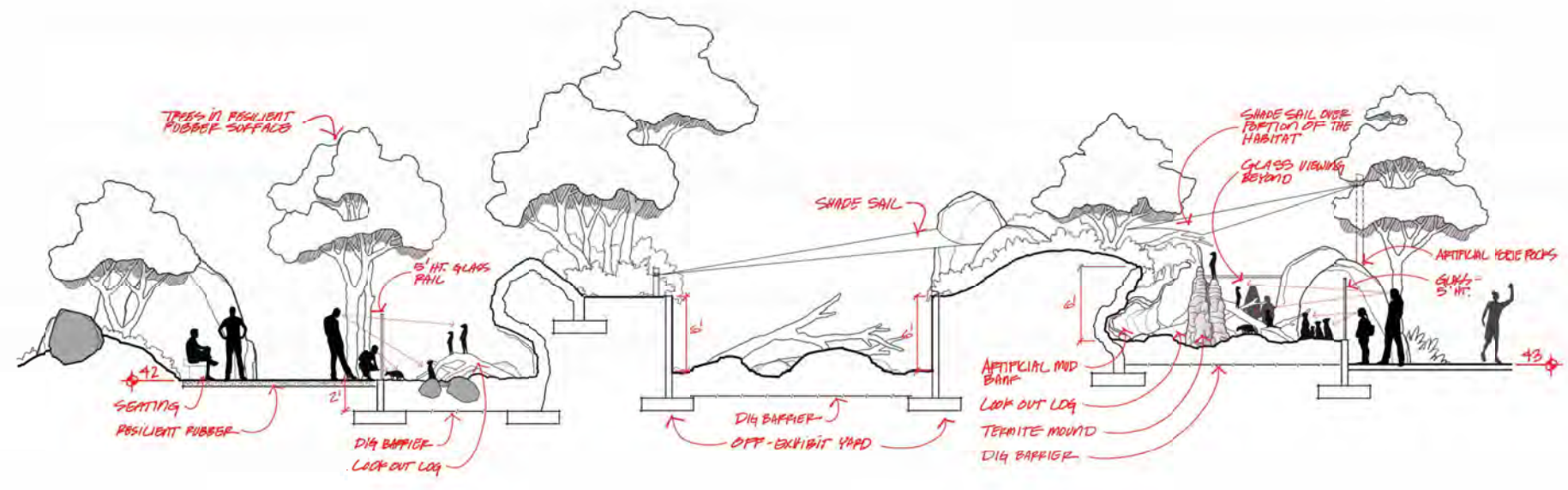

1 Meerkat - Section  
1/4" = 1'-0"

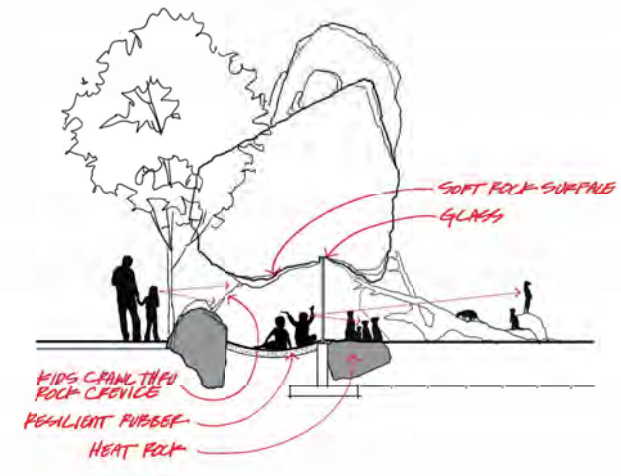

2 Meerkat Crawl-Through - Section  
1/4" = 1'-0"



REV DATE	DESCRIPTION
1	09/22/2023 For Review
2	10/06/2023 For Pricing

NOT FOR CONSTRUCTION

The New Zoo at Elk Grove

SECTIONS - MEERKAT

SHEET SIZE:	ARCH E (36" x 48")
DATE:	06 October 2023
SCALE:	As indicated
CHECKED:	SMK/Mc
SHEET:	

X315

Schematic Plans

PHOTO COURTESY: SACRAMENTO ZOOLOGICAL SOCIETY



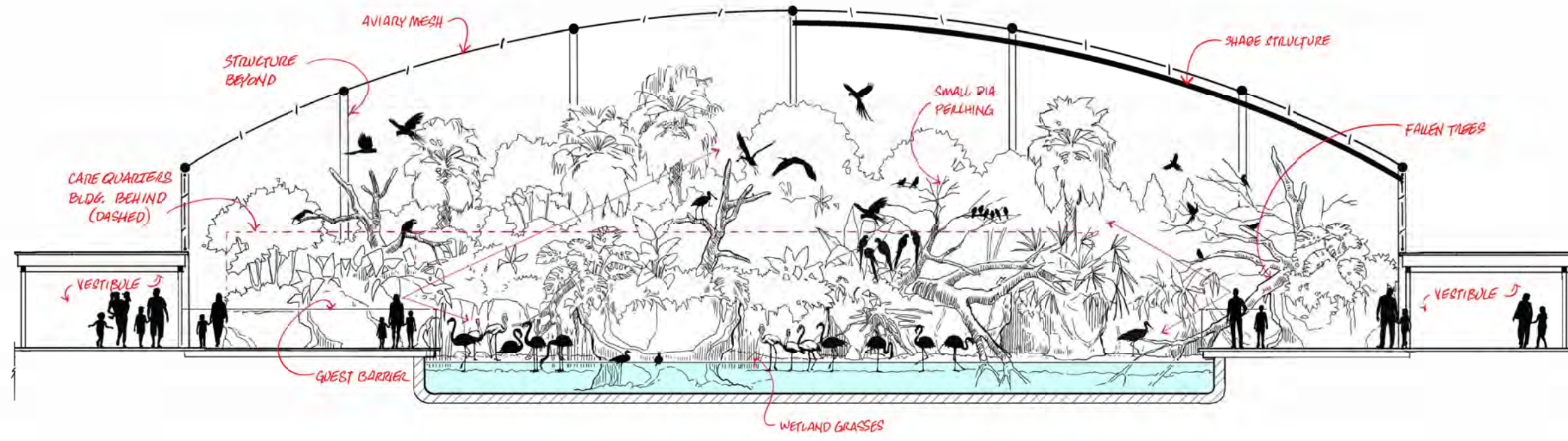

1 Flamingo North South - Section  
1/4" = 1'-0"

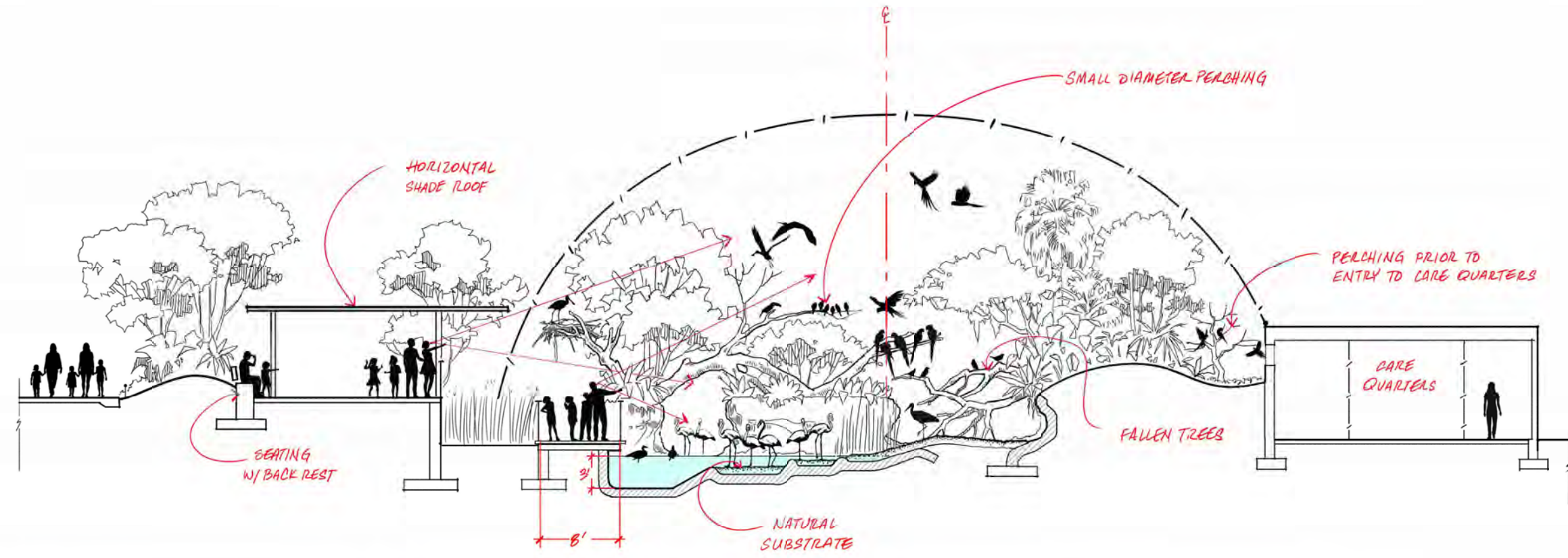

2 Flamingo East West - Section  
1/4" = 1'-0"



Sacramento Zoological Society  
3535 W. Land Park Drive  
Sacramento, CA, USA



SHR Studios  
250 Madison Way N.E. #220  
Burlington, VT 05401  
phone (205) 842-8332  
shrstudios.com



REV DATE	DESCRIPTION
1 09/22/2023	For Review
2 10/06/2023	For Pricing

NOT FOR CONSTRUCTION

The New Zoo at Elk Grove

SECTIONS - FLAMINGO

SHEET SIZE: ARCH E (36" x 48")  
DATE: 06 October 2023  
SCALE: As indicated  
CHECKED: SMK/mc  
SHEET:

X316

Schematic Plans

PROPERTY OF SHR STUDIOS, INC. USE OF PHOTOGRAPHS PROVIDED WITHOUT IMPLIED OR OTHERWISE ASSERTED WARRANTIES.







REV DATE	DESCRIPTION
1 09/22/2023	For Review
2 10/06/2023	For Pricing

NOT FOR CONSTRUCTION

The New Zoo at Elk Grove

SECTIONS - GELADA

SHEET SIZE: ARCH E (36" x 48")  
DATE: 06 October 2023  
SCALE: As indicated  
CHECKED: SMK/Mc  
SHEET:

X318

Schematic Plans

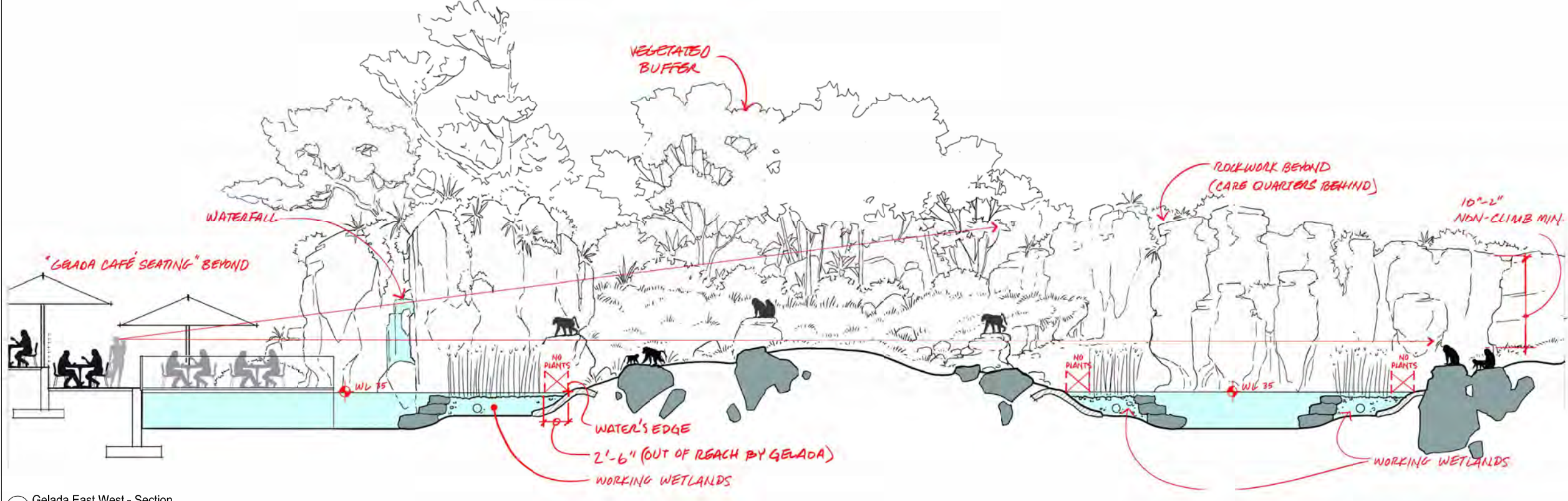

1 Gelada East West - Section  
1/4" = 1'-0"

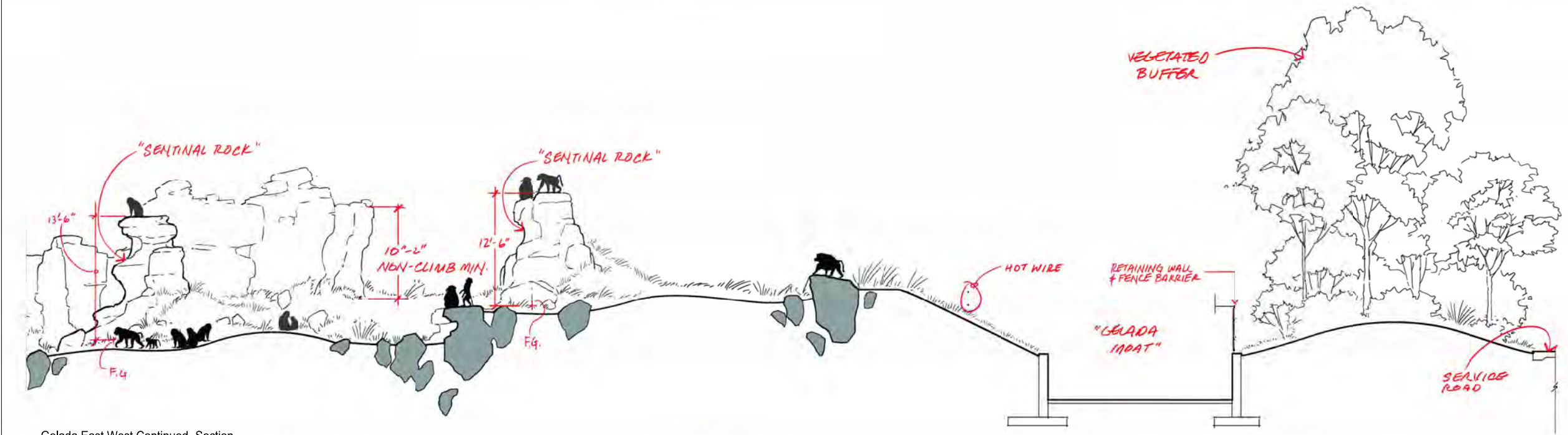

Gelada East West Continued- Section  
1/4" = 1'-0"



PHOTO: SHUTTERSTOCK.COM

PROPERTY OF SHR STUDIOS INC. USE OF PHOTOGRAPHS PROVIDED WITHOUT WARRANTY. ALL RIGHTS RESERVED.







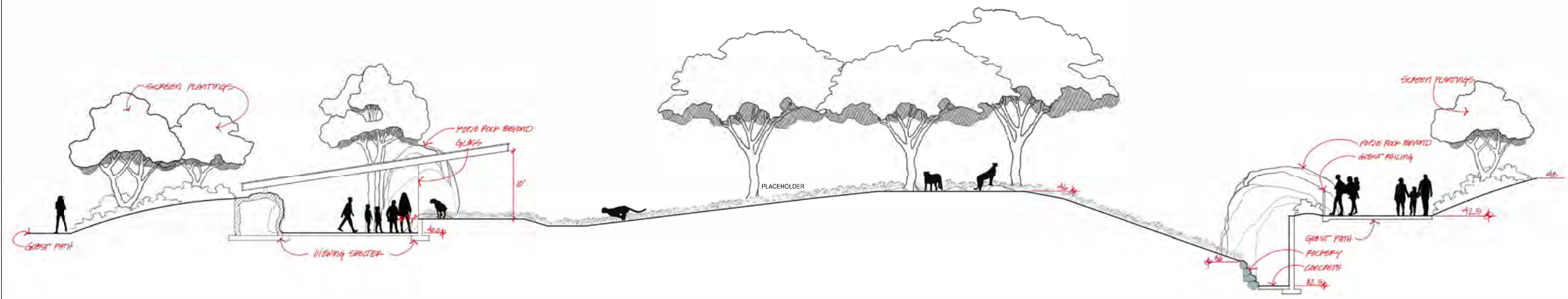

1 Cheetah - Section  
3/16" = 1'-0"

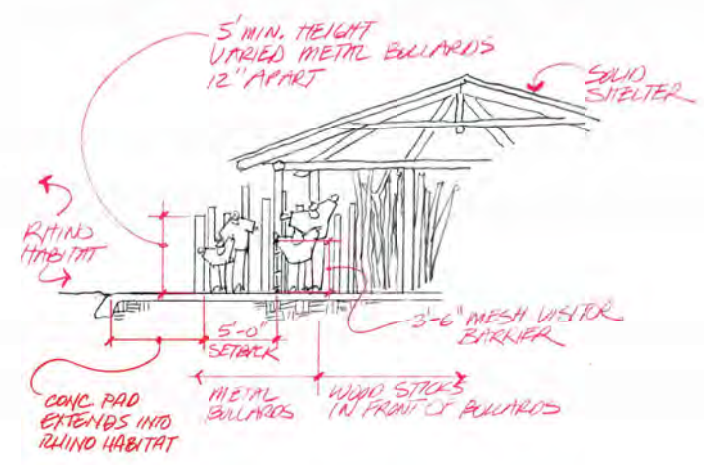

2 Rhino Boma - Section  
1/4" = 1'-0"

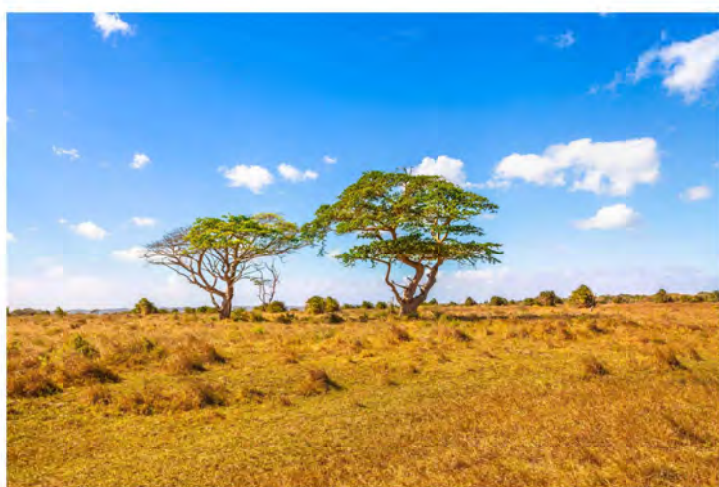

REV	DATE	DESCRIPTION
1	09/22/2023	For Review
2	10/06/2023	For Pricing

NOT FOR CONSTRUCTION

The New Zoo at Elk Grove

SECTIONS - CHEETAH AND RHINO

SHEET SIZE: ARCH E (36" x 48")  
DATE: 06 October 2023  
SCALE: As indicated  
CHECKED: SMK/Mc  
SHEET:

**X320**

Schematic Plans







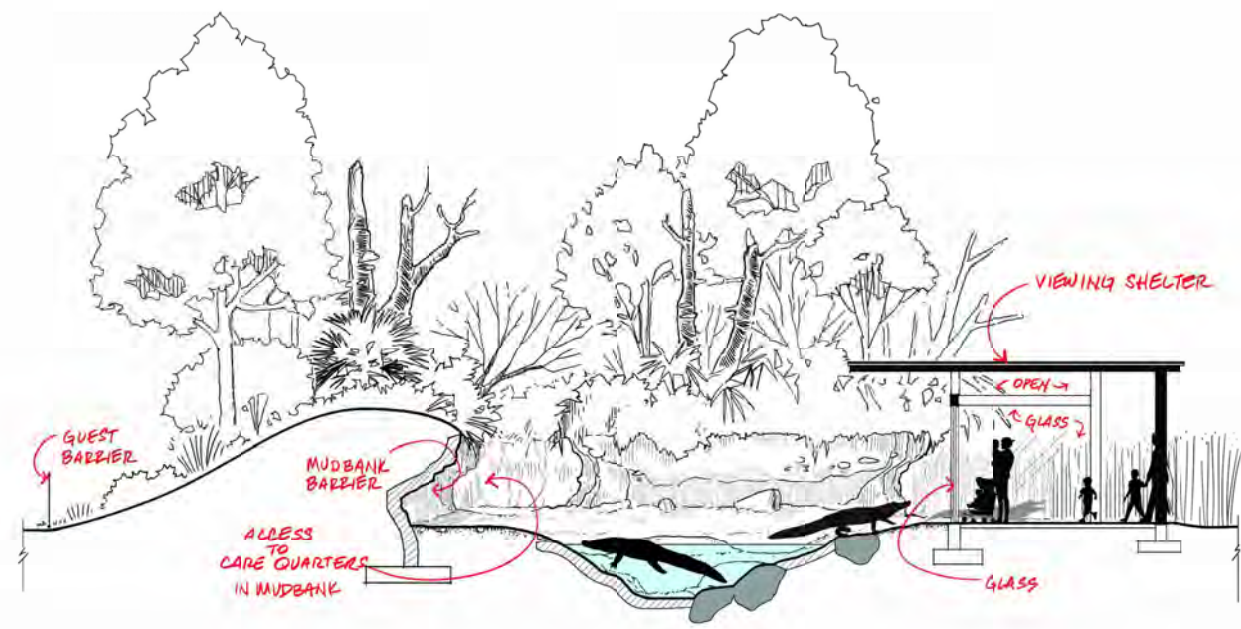

1 Alligator - Section  
1/4" = 1'-0"

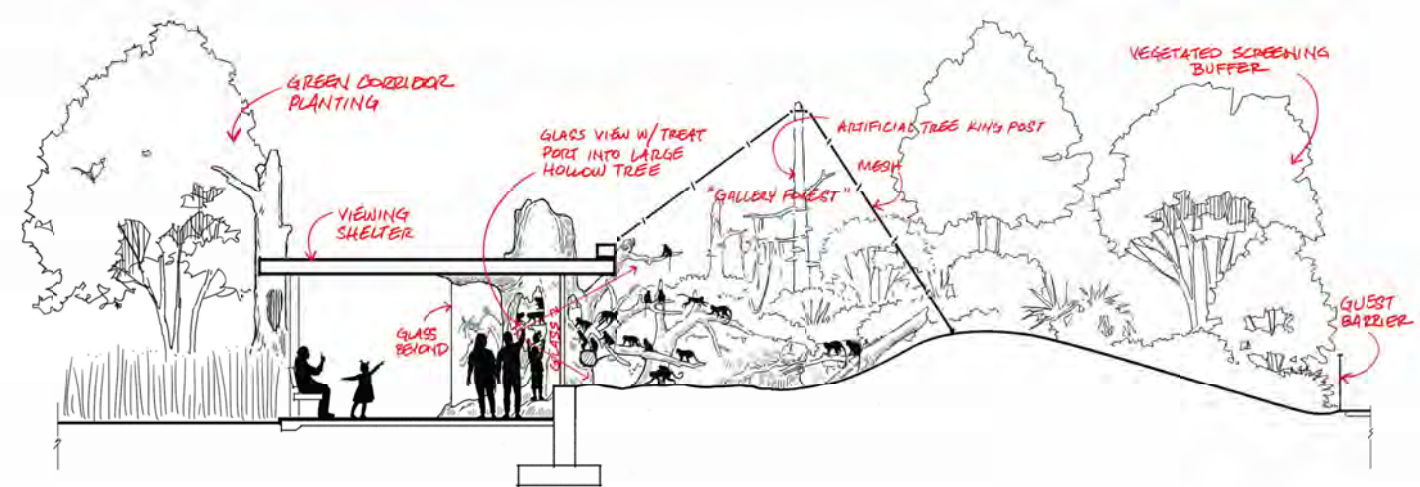

2 Squirrel Monkey - Section  
1/4" = 1'-0"

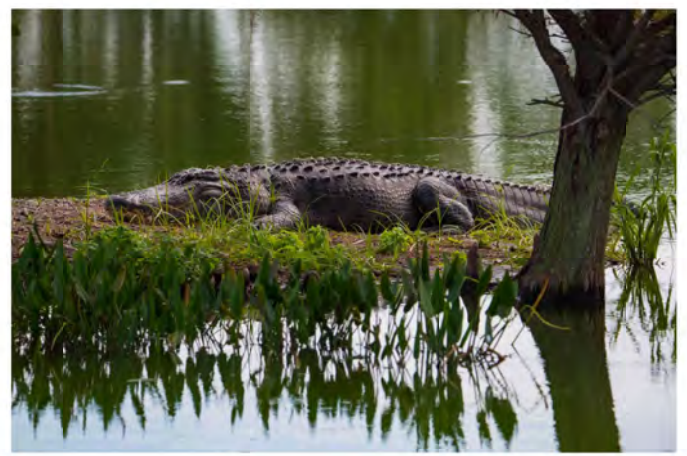

Sacramento Zoological Society  
3500 W. Land Park Drive  
Sacramento, CA USA



SH R Studios  
250 Madison Way N.E. #220  
Burlington, VT 05401  
phone (205) 842-8332  
shrstudios.com



REV	DATE	DESCRIPTION
1	09/22/2023	For Review
2	10/06/2023	For Pricing

NOT FOR CONSTRUCTION

The New Zoo at Elk Grove

SECTIONS - ALLIGATOR AND SQUIRREL MONKEY

SHEET SIZE: ARCH E (36" x 48")  
DATE: 06 October 2023  
SCALE: As indicated  
CHECKED: SMK/ML  
SHEET:

X322

Schematic Plans

PHOTO: SHUTTERSTOCK.COM

PROPERTY OF SHR STUDIOS, INC. USE OF PHOTOGRAPHS PROVIDED WITHOUT WARRANTY OR LIABILITY. ALL RIGHTS RESERVED.



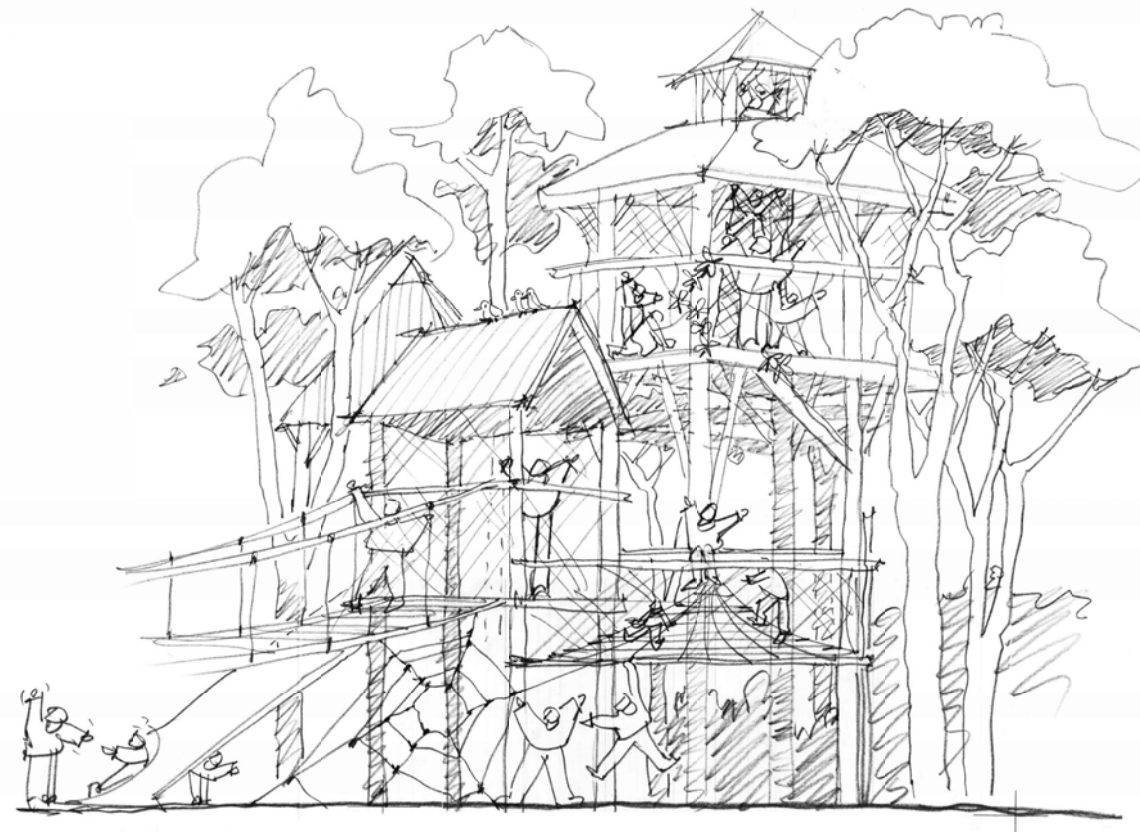

1 Play Area - Section  
1" = 1'-0"



Sacramento Zoological Society  
3530 W. Land Park Drive  
Sacramento, CA USA



SH R Studios  
250 Madonna Way N.E. #220  
Bainbridge Island, WA 98110  
phone (206) 842-8332  
shrstudios.com

NOLL & TAM  
ARCHITECTS

Kimley Horn



exp.

REV DATE	DESCRIPTION
1 09/22/2023	For Review
2 10/06/2023	For Pricing

NOT FOR CONSTRUCTION

The New Zoo at Elk Grove

SECTIONS - PLAY

SHEET SIZE: ARCH E (36" x 48")  
DATE: 06 October 2023  
SCALE: As indicated  
CHECKED: SMK/mc  
SHEET:

X323

Schematic Plans

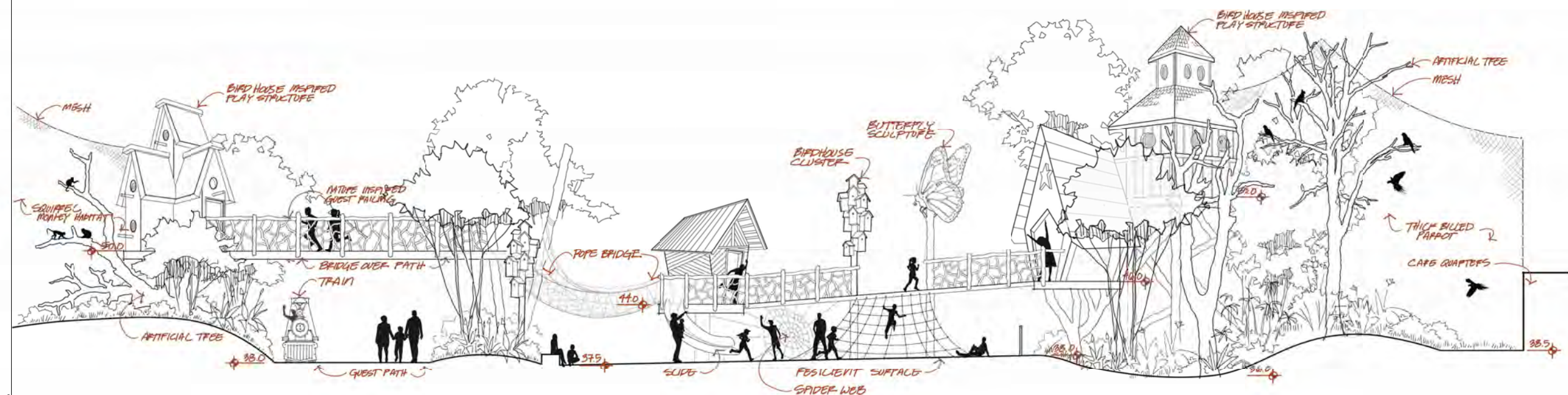

2 Thick Billed Parrot and Play - Section  
1/4" = 1'-0"

PROPERTY OF SHR STUDIOS, INC. USE OF THIS DOCUMENT IS PROHIBITED WITHOUT THE WRITTEN PERMISSION. ALL RIGHTS RESERVED.



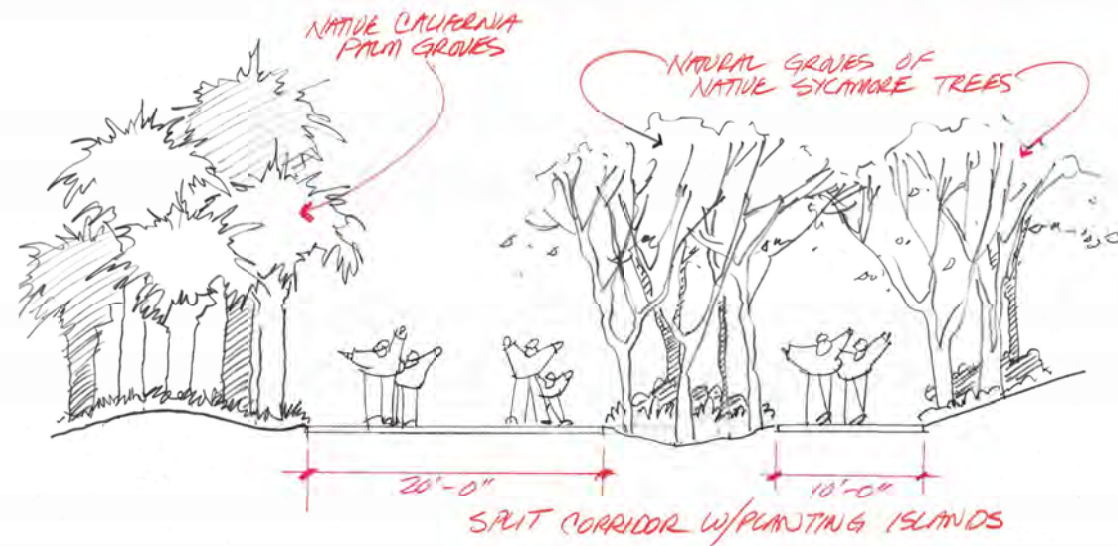

1 Green Corridor Planting Islands - Section  
1" = 1'-0"

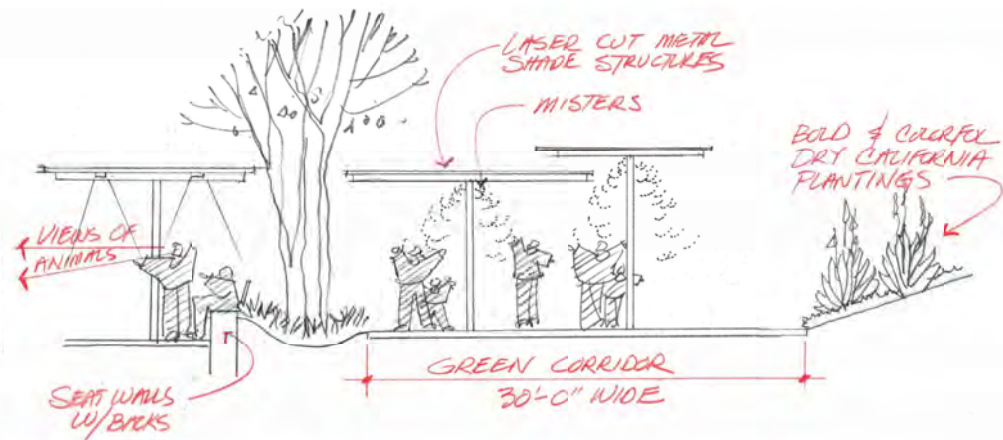

2 Green Corridor Shade Structure - Section  
1" = 1'-0"

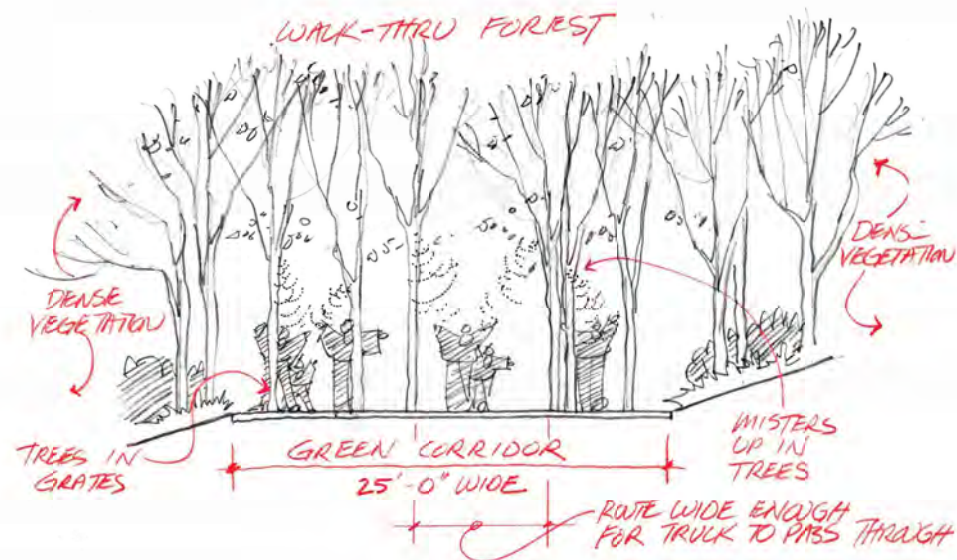

3 Green Corridor Walk Through Forest - Section  
1" = 1'-0"

REV	DATE	DESCRIPTION
1	09/22/2023	For Review
2	10/06/2023	For Pricing

NOT FOR CONSTRUCTION

The New Zoo at Elk Grove

SECTIONS - GREEN CORRIDOR

SHEET SIZE:	ARCH E (36" x 48")
DATE:	06 October 2023
SCALE:	1" = 1'-0"
CHECKED:	SMK/nc
SHEET:	

X324

Schematic Plans



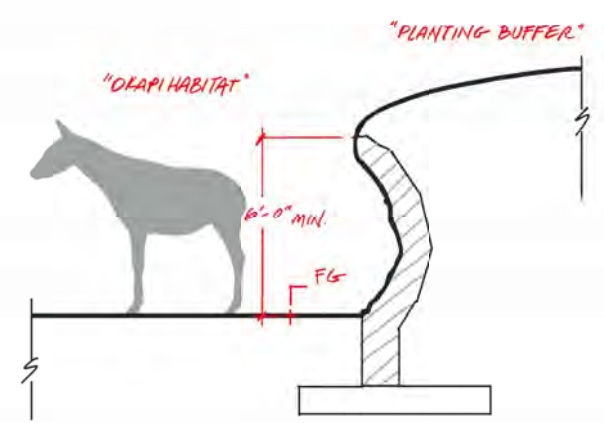

1 C1 - Okapi Mudbank - Section  
1/2" = 1'-0"

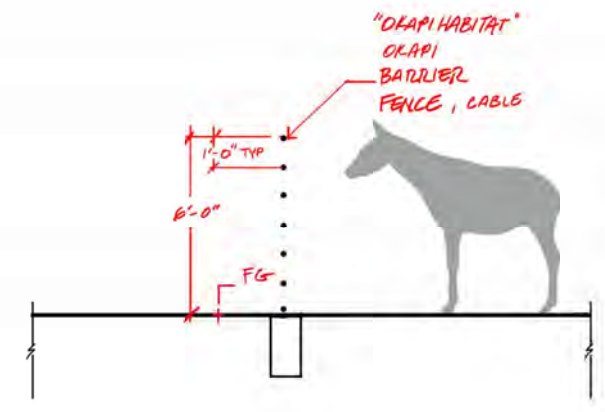

2 C2 - Okapi Fence - Section  
1/2" = 1'-0"

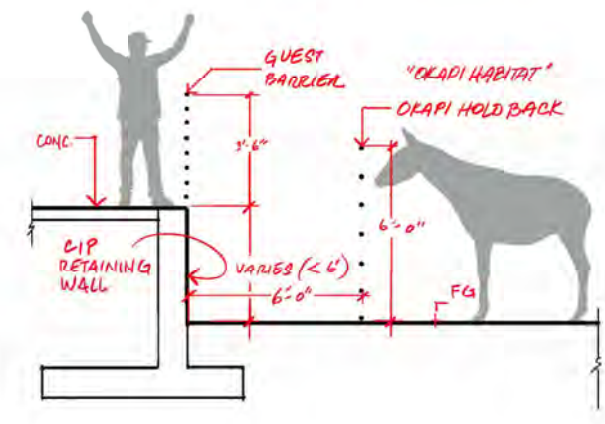

3 C3 - Okapi CIP Retaining Wall - Section  
1/2" = 1'-0"

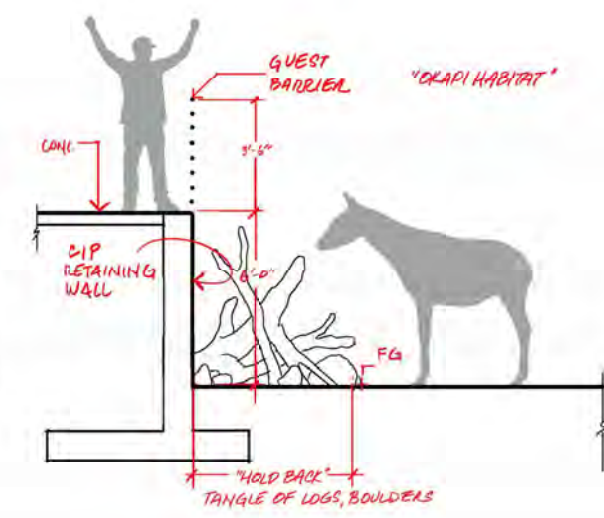

4 C4 - Okapi CIP Retaining Wall Tall - Section  
1/2" = 1'-0"

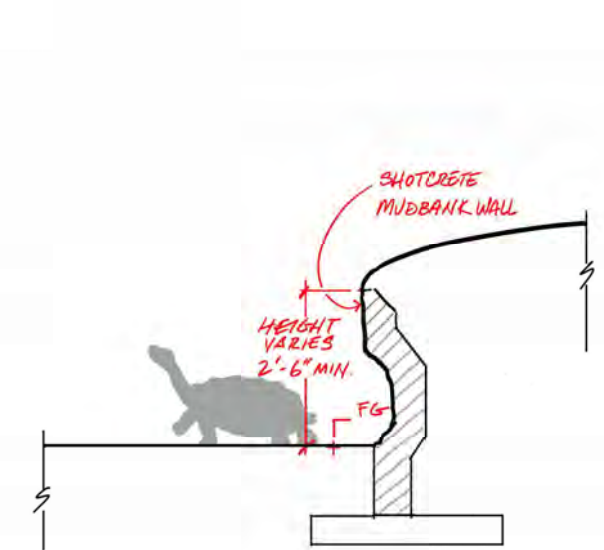

5 D1 - Tortoise Mudbank - Section  
1/2" = 1'-0"

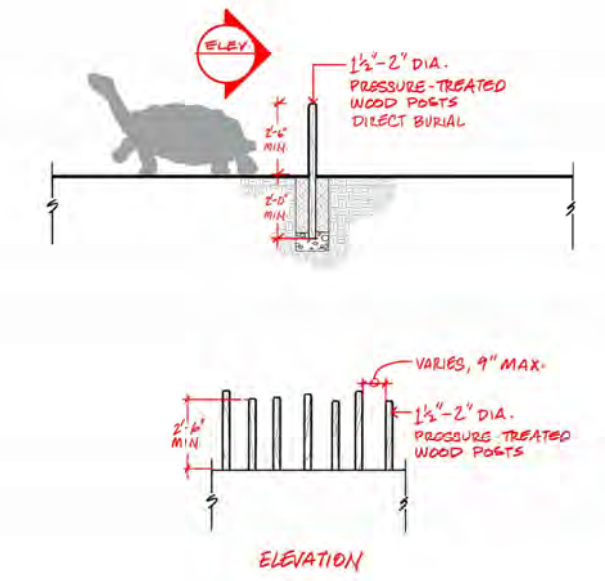

6 D2 - Tortoise Reed - Section  
1/2" = 1'-0"

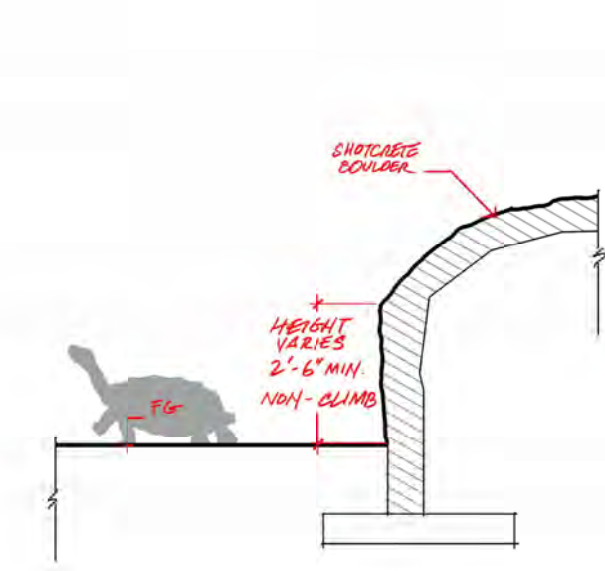

7 D3 - Tortoise Rockwork - Section  
1/2" = 1'-0"

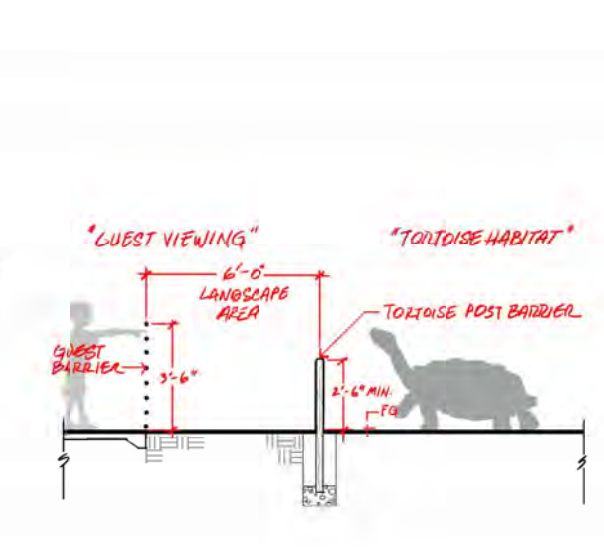

8 D4 - Tortoise Viewing - Section  
1/2" = 1'-0"

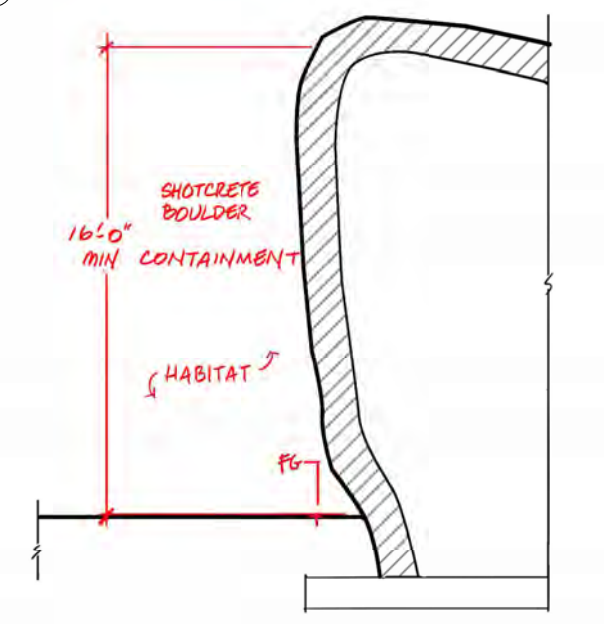

9 I2 - Lion Rockwork - Section  
1/2" = 1'-0"

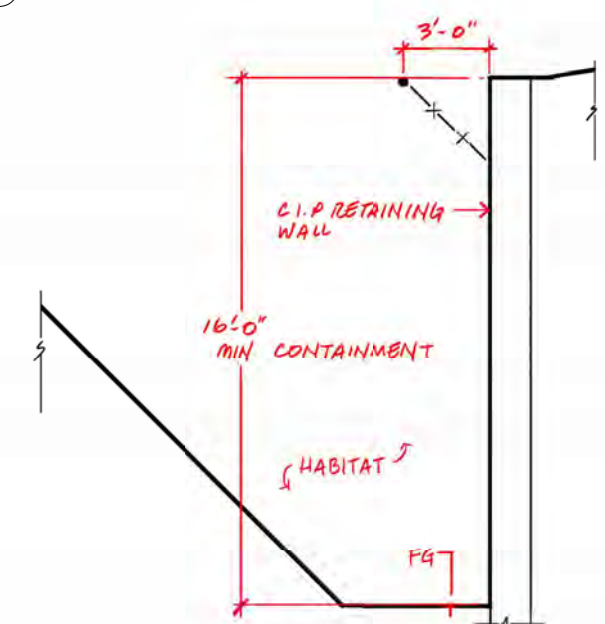

10 I3 - Lion CIP Wall - Section  
1/2" = 1'-0"

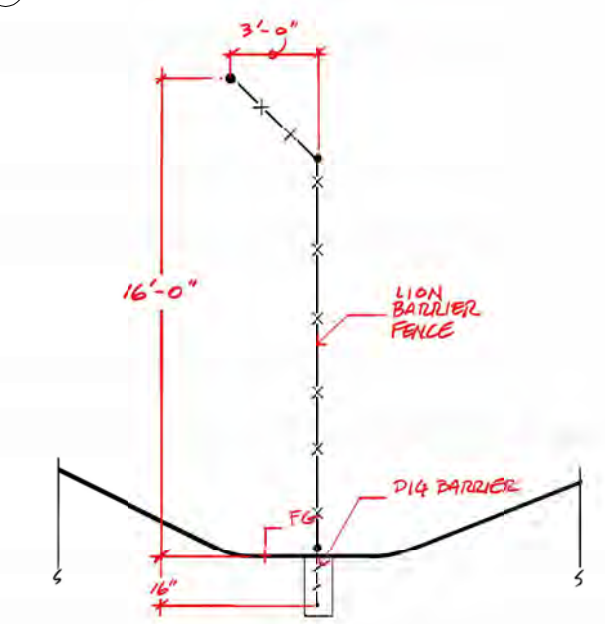

11 I4 - Lion Fence - Section  
1/2" = 1'-0"

REV	DATE	DESCRIPTION
1	09/22/2023	For Review
2	10/06/2023	For Pricing

NOT FOR CONSTRUCTION

The New Zoo at Elk Grove

BARRIER DETAILS - OKAPI, TORTOISE, LION

SHEET SIZE: ARCH E (36" x 48")  
DATE: 06 October 2023  
SCALE: 1/2" = 1'-0"  
CHECKED: SMK/Mc  
SHEET:

**X330**

Schematic Plans

PROPERTY OF SHR STUDIOS, INC. USE OF PHOTOGRAPHS PROVIDED HEREIN FOR THE DEVELOPER IS SOLELY FOR REPRESENTATIONAL PURPOSES AND DOES NOT CONSTITUTE AN ENDORSEMENT OR GUARANTEE OF ANY KIND.



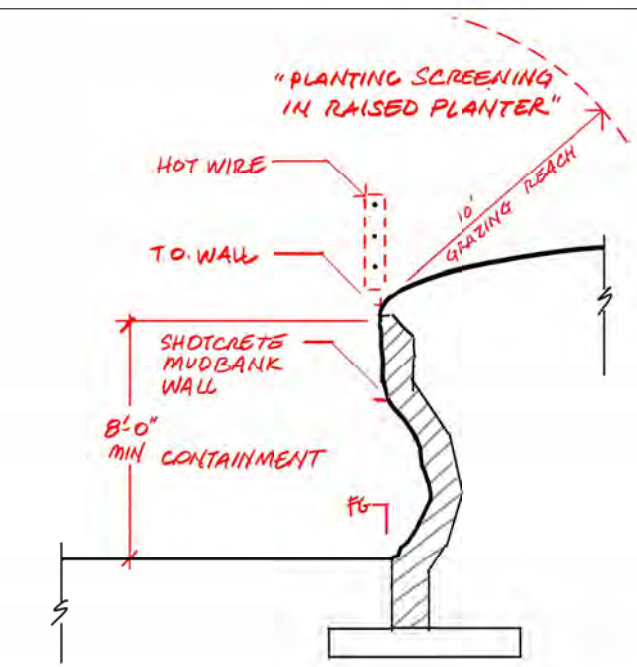

1 A1 & B1 Savanna Mudbank - Section  
1/2" = 1'-0"

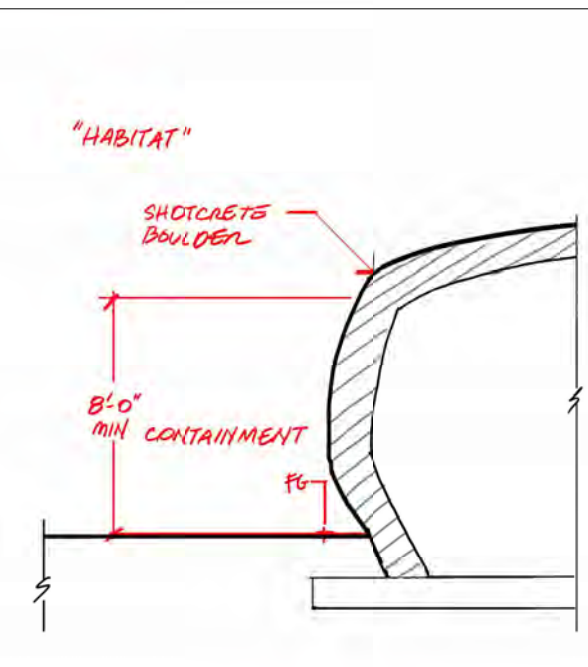

2 A2 & B2 Savanna Rockwork - Section  
1/2" = 1'-0"

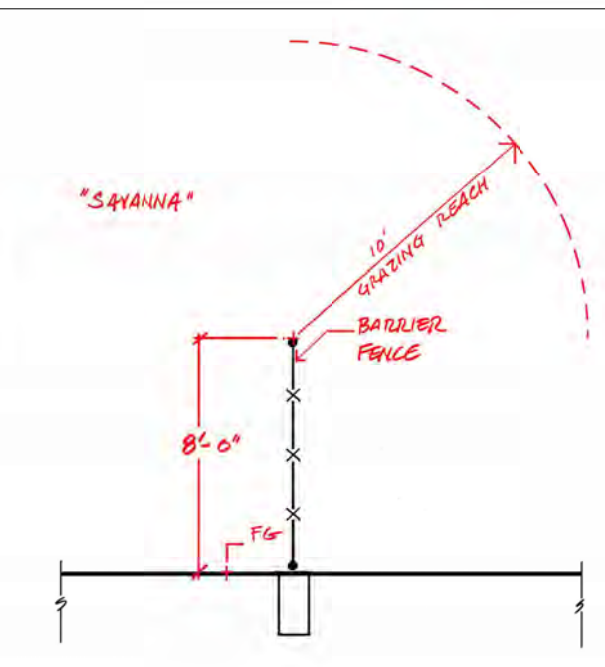

3 A3 & B3 Savanna Fence - Section  
1/2" = 1'-0"

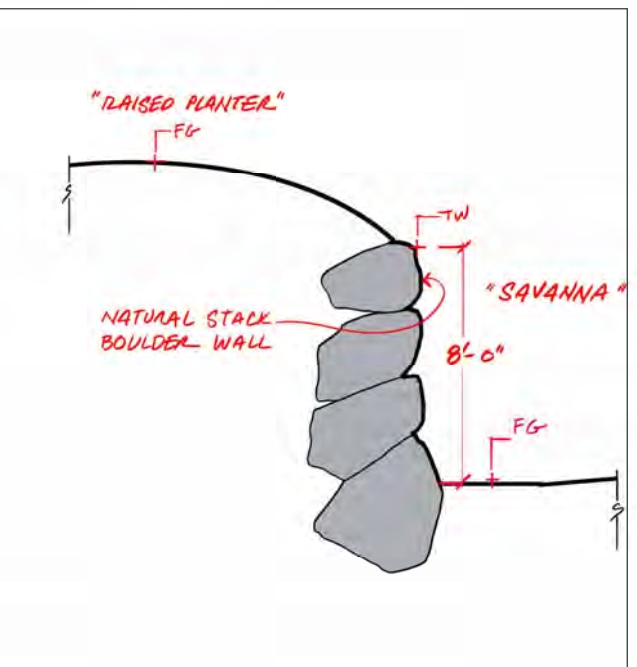

4 A4 & B4 Savanna Rock Wall - Section  
1/2" = 1'-0"

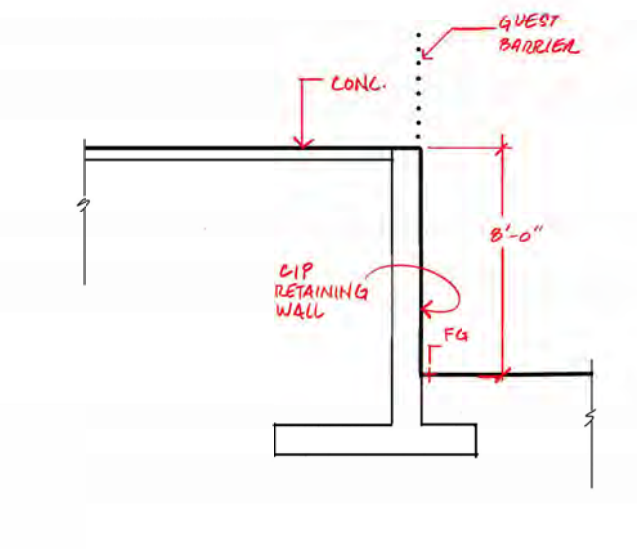

5 B5 Savanna CIP Retaining Wall - Section  
1/2" = 1'-0"

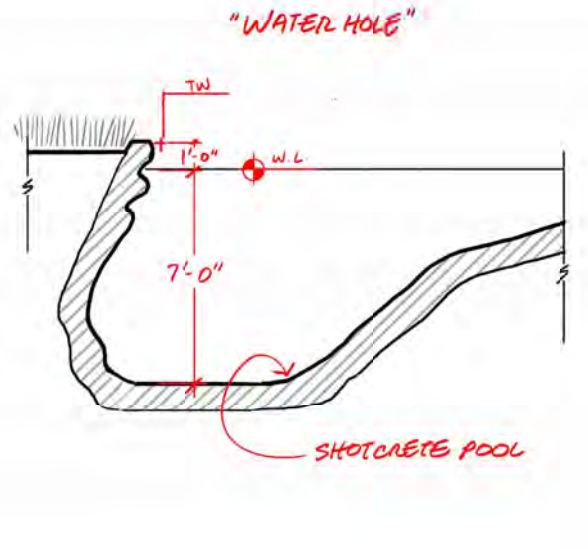

6 B6 Savanna Water as a Barrier - Section  
1/2" = 1'-0"

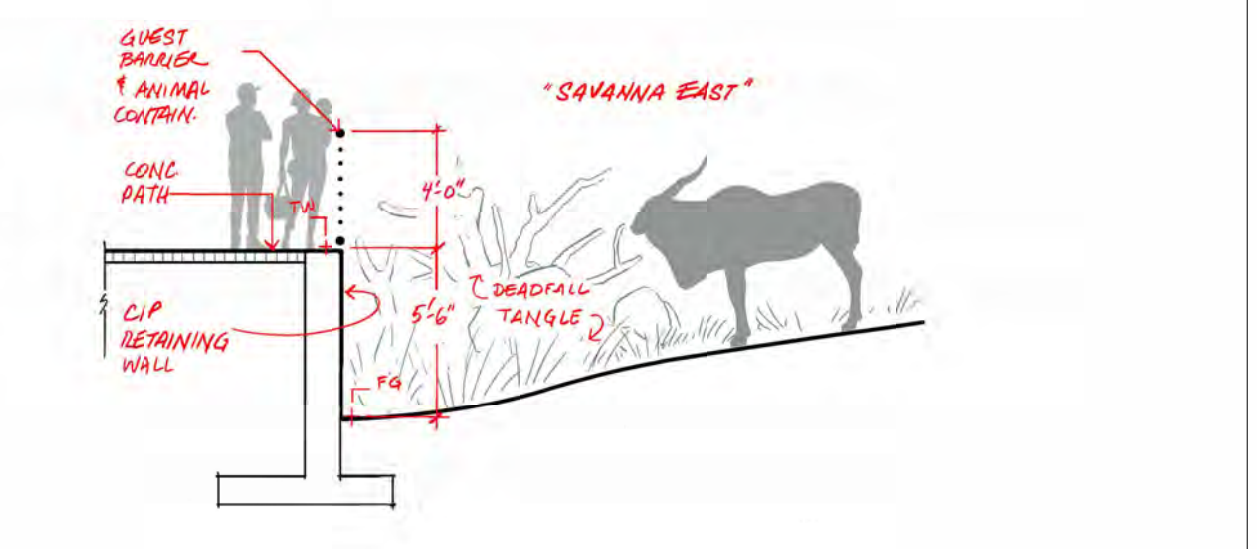

7 A5 Savanna CIP Wall View - Section  
1/2" = 1'-0"

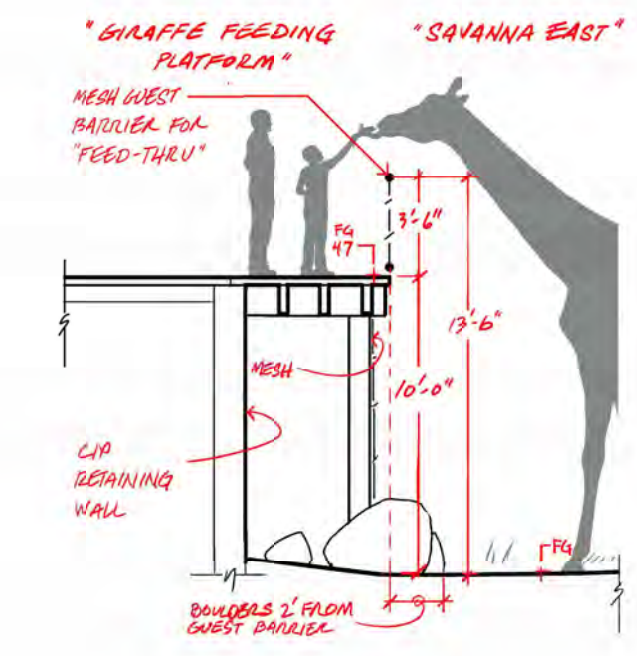

8 A8 Savanna Giraffe Feeding - Section  
1/2" = 1'-0"

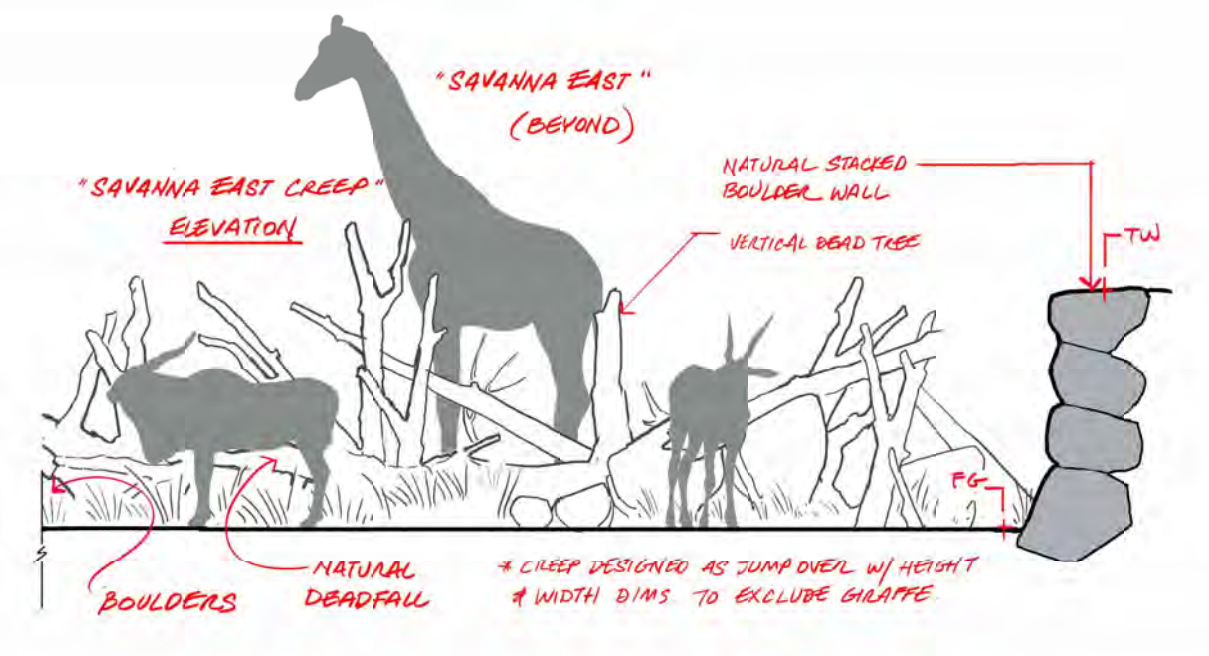

9 A7 Savanna Creep - Section Elevation  
1/2" = 1'-0"

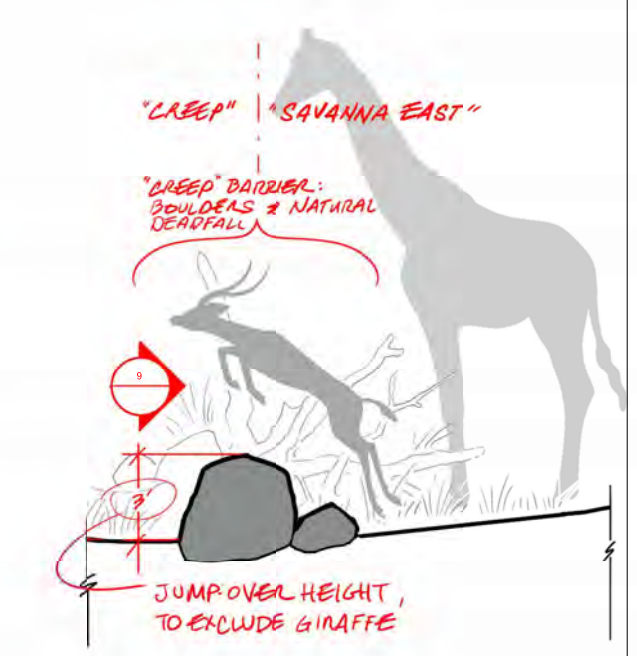

10 A7 Savanna Creep - Section  
1/2" = 1'-0"

REV	DATE	DESCRIPTION
1	09/22/2023	For Review
2	10/06/2023	For Pricing

NOT FOR CONSTRUCTION

The New Zoo at Elk Grove

BARRIER DETAILS - SAVANNA

SHEET SIZE: ARCH E (36" x 48")  
DATE: 06 October 2023  
SCALE: 1/2" = 1'-0"  
CHECKED: SMK/mc  
SHEET:

**X331**

Schematic Plans



REV. DATE	DESCRIPTION
1	09/22/2023 For Review
2	10/06/2023 For Pricing

NOT FOR CONSTRUCTION

The New Zoo at Elk Grove

BARRIER DETAILS -  
CHEETAH, RHINO, AND  
ALLIGATOR

SHEET SIZE: ARCH E (36" x 48")  
DATE: 06 October 2023  
SCALE: 1/2" = 1'-0"  
CHECKED: SMK/MC  
SHEET:

**X332**

Schematic Plans

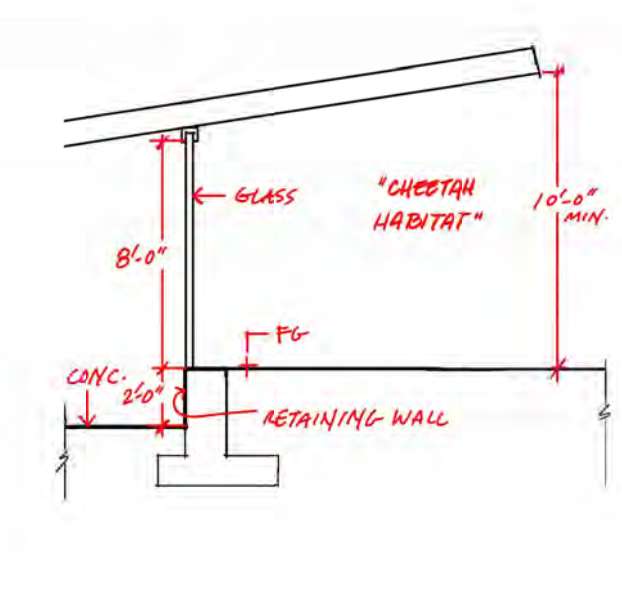

1 G1 - Cheetah Glass Viewing - Section  
1/2" = 1'-0"

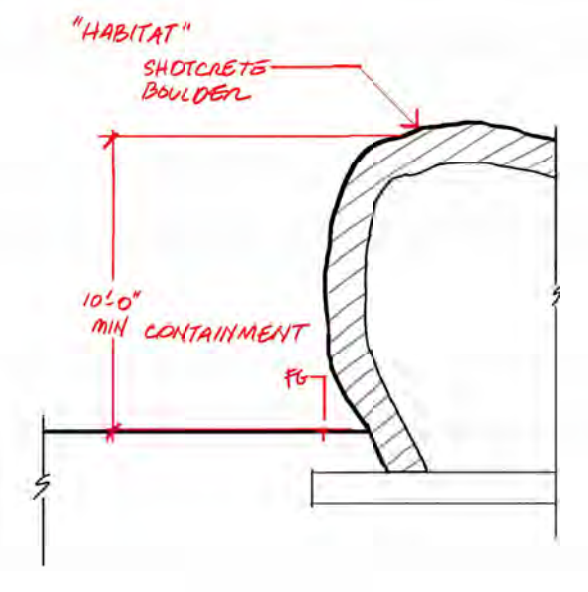

2 G2 - Cheetah Rockwork - Section  
1/2" = 1'-0"

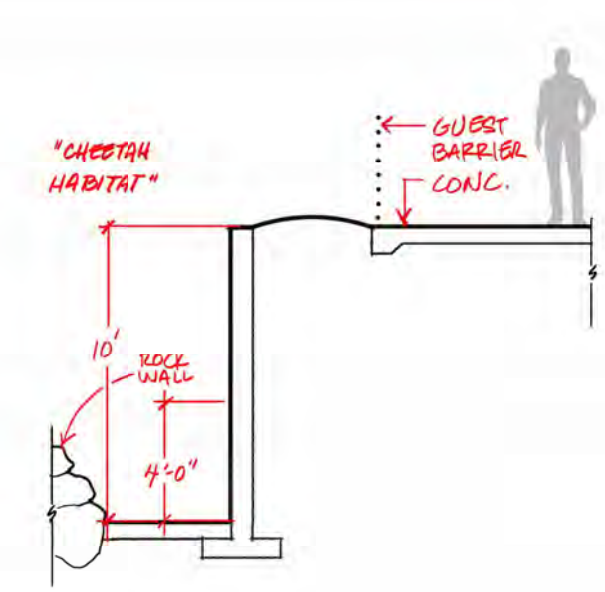

3 G3 - Cheetah CIP Wall - Section  
1/2" = 1'-0"

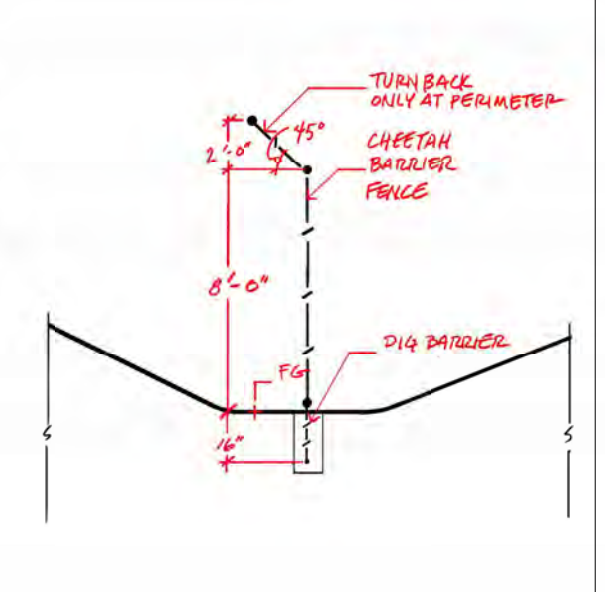

4 G4 - Cheetah Fence - Section  
1/2" = 1'-0"

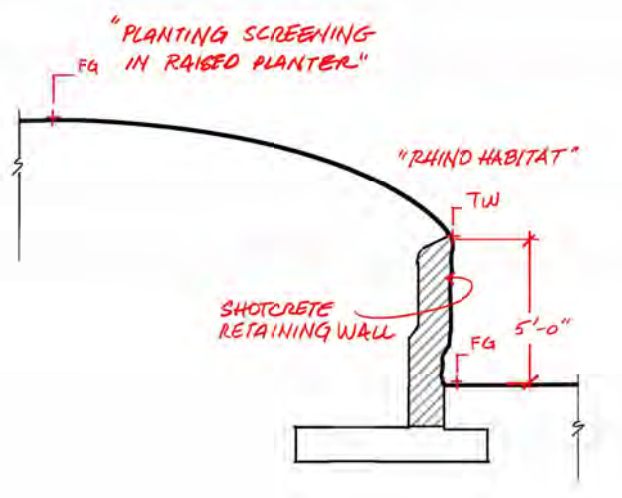

5 H2 - Rhino Mudbank - Section  
1/2" = 1'-0"

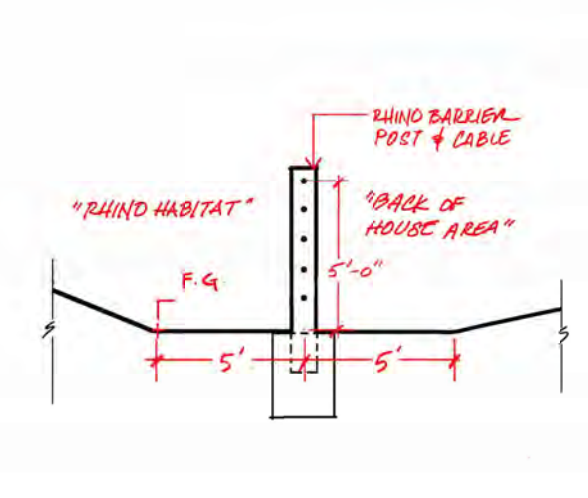

6 H3 - Rhino Cable - Section  
1/2" = 1'-0"

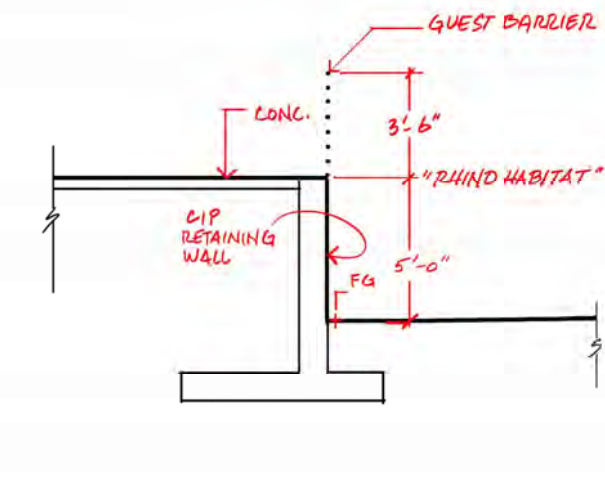

7 H4 - Rhino CIP Wall - Section  
1/2" = 1'-0"

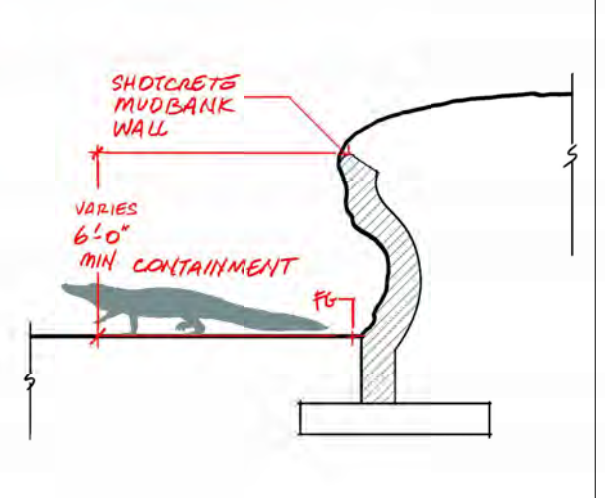

8 F1 - Alligator Mud Bank - Section  
1/2" = 1'-0"

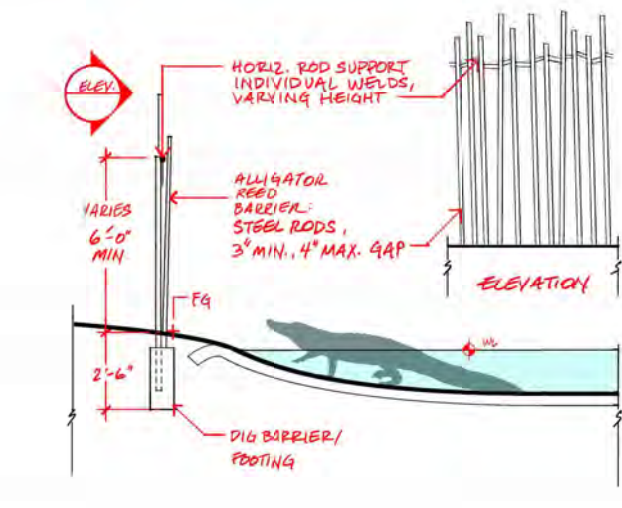

9 F2 - Alligator Reeds - Section  
1/2" = 1'-0"

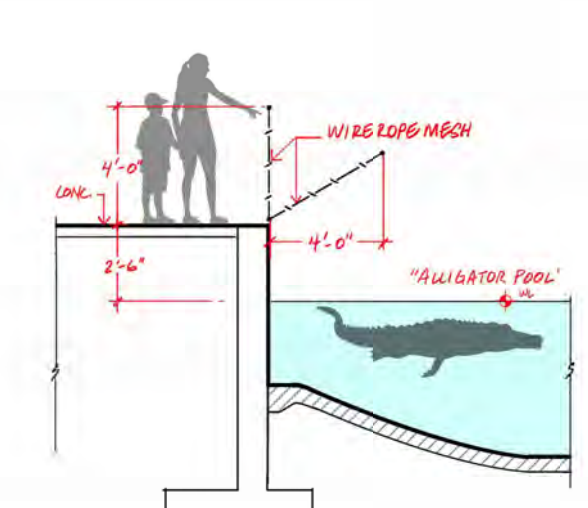

10 F3 - Alligator Glass Rail - Section  
1/2" = 1'-0"

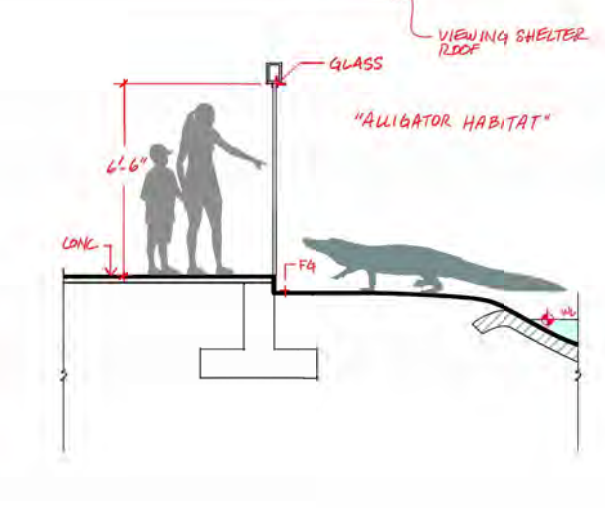

11 F4 - Alligator Glass Viewing - Section  
1/2" = 1'-0"

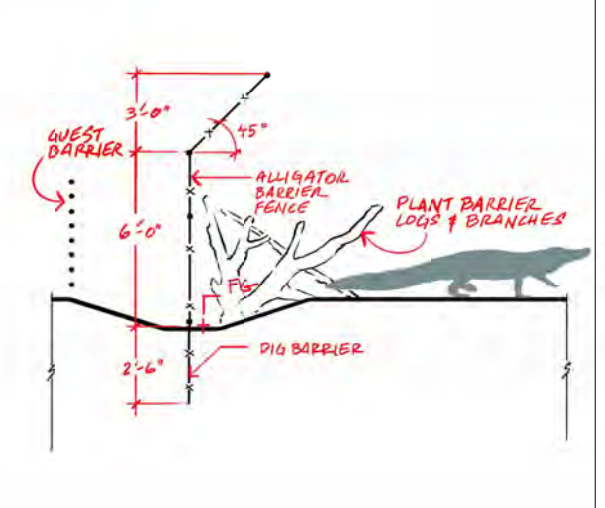

12 F5 - Alligator Fence - Section  
1/2" = 1'-0"

PROPERTY OF SHR STUDIOS, INC. USE OF THIS DOCUMENT FOR ANY OTHER PROJECT WITHOUT THE WRITTEN CONSENT OF SHR STUDIOS IS PROHIBITED.



REV	DATE	DESCRIPTION
1	09/22/2023	For Review
2	10/06/2023	For Pricing

NOT FOR CONSTRUCTION

The New Zoo at Elk Grove

BARRIER DETAILS - GELADA

SHEET SIZE: ARCH E (36" x 48")  
DATE: 06 October 2023  
SCALE: 1/2" = 1'-0"  
CHECKED: SMK/mc  
SHEET:

**X333**

Schematic Plans

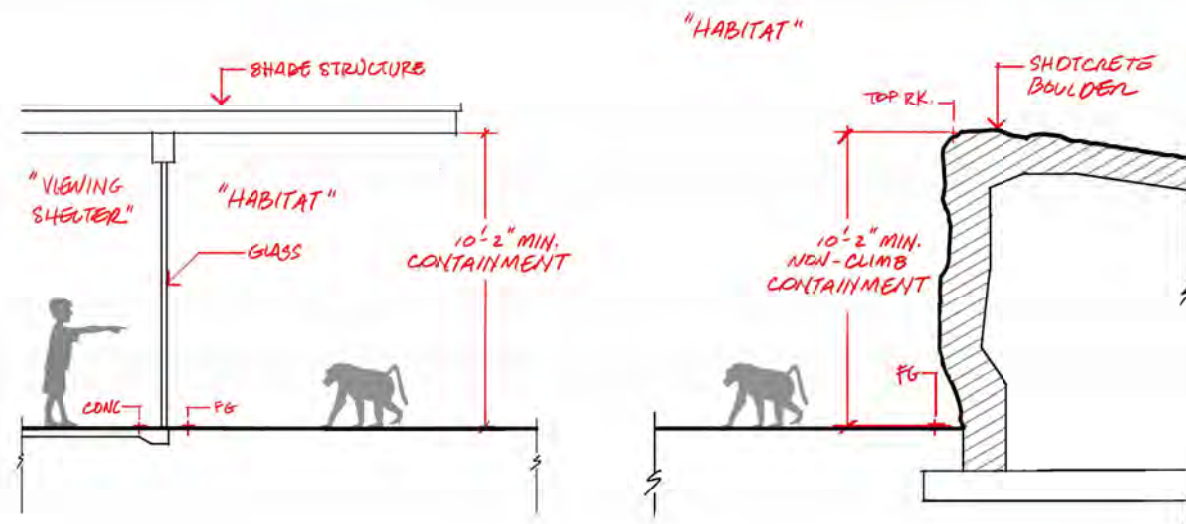

1 E1 - Gelada Glass Viewing - Section  
1/2" = 1'-0"

2 E2 - Gelada Boulder Rockwork - Section  
1/2" = 1'-0"

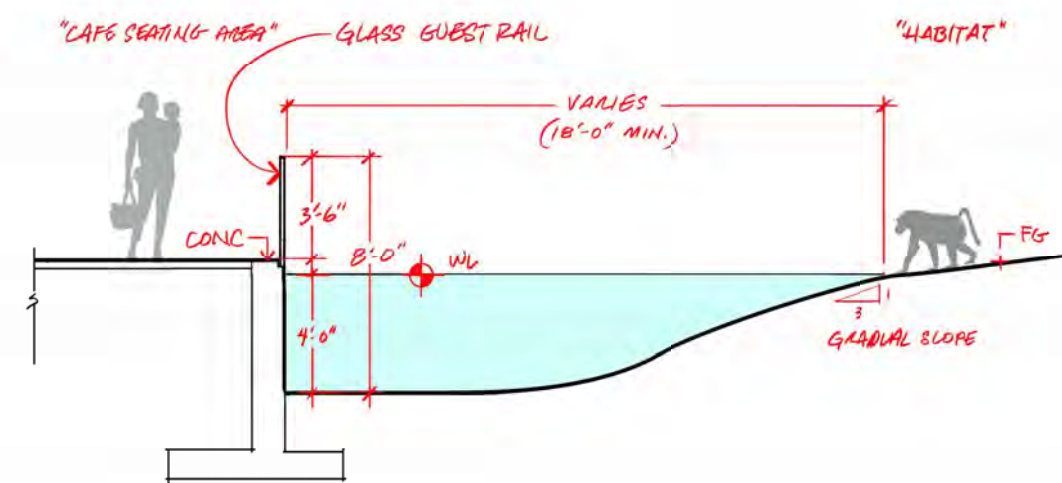

3 E3 - Gelada Water as a Barrier at Cafe - Section  
1/2" = 1'-0"

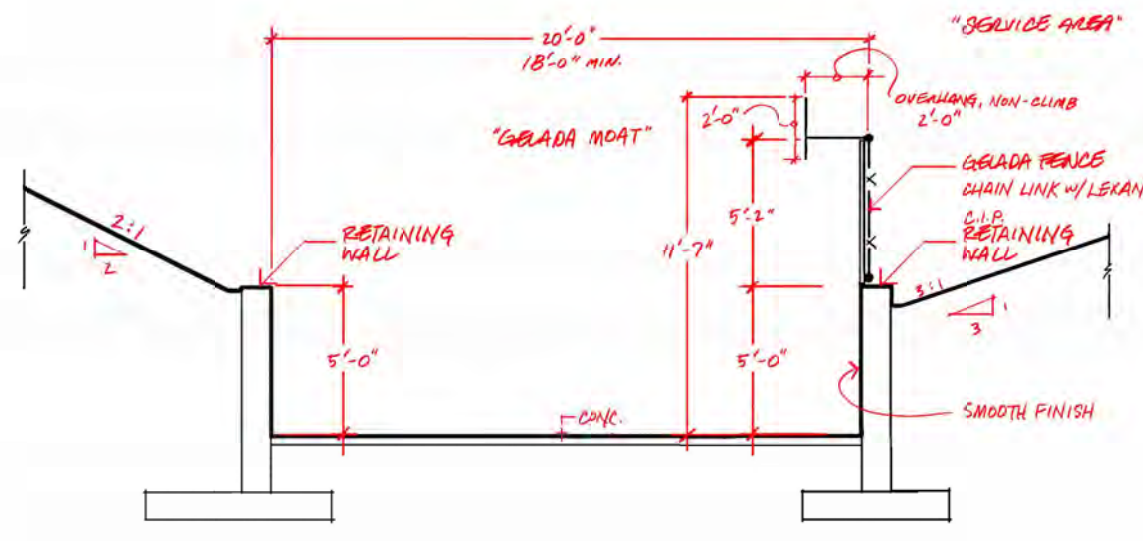

4 E4 - Gelada Retaining Wall and Fence - Section  
1/2" = 1'-0"

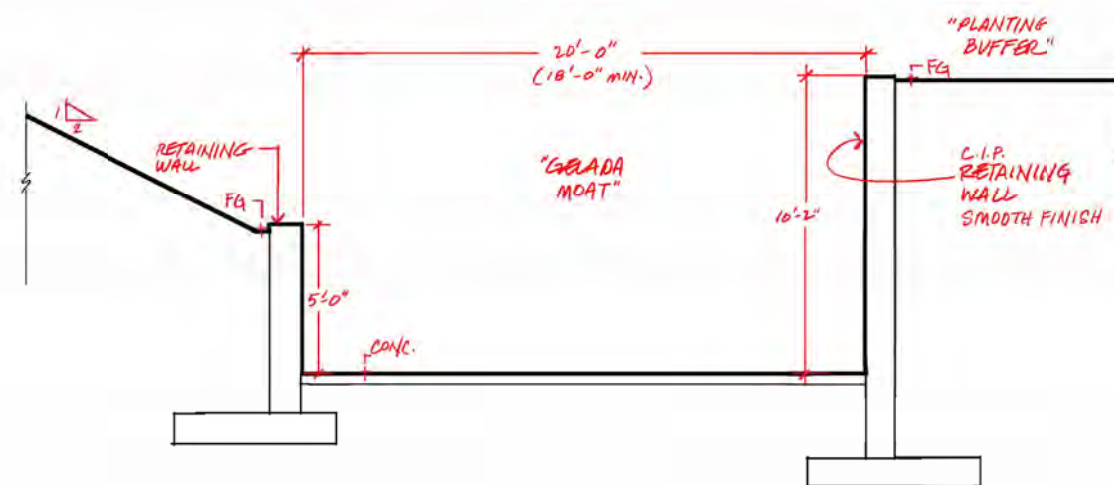

5 E5 - Gelada Retaining Moat Wall - Section  
1/2" = 1'-0"

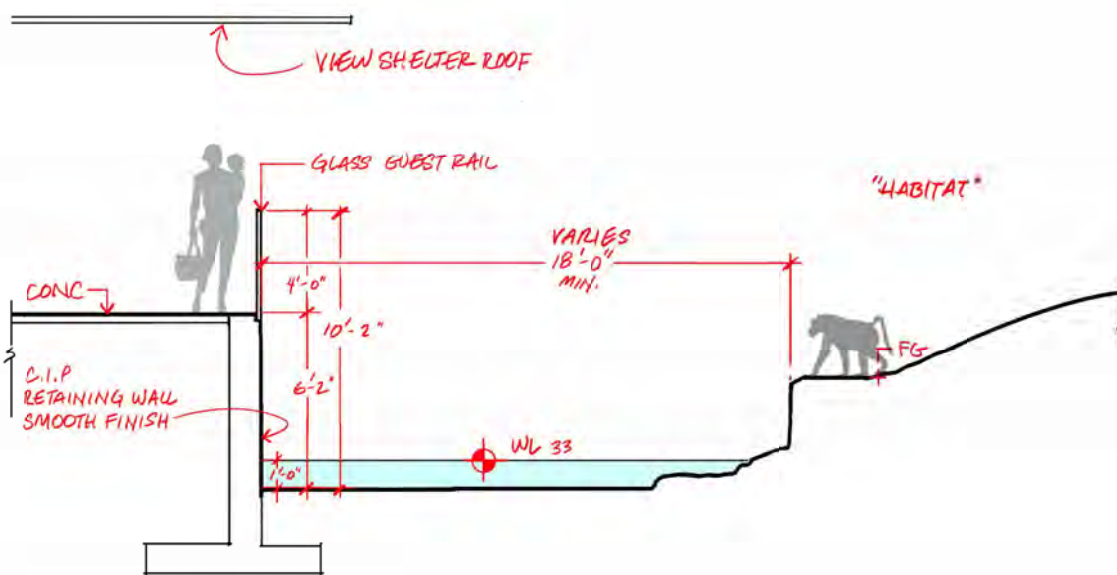

6 E6 - Gelada Retaining and Glass Rail at View Shelter - Section  
1/2" = 1'-0"



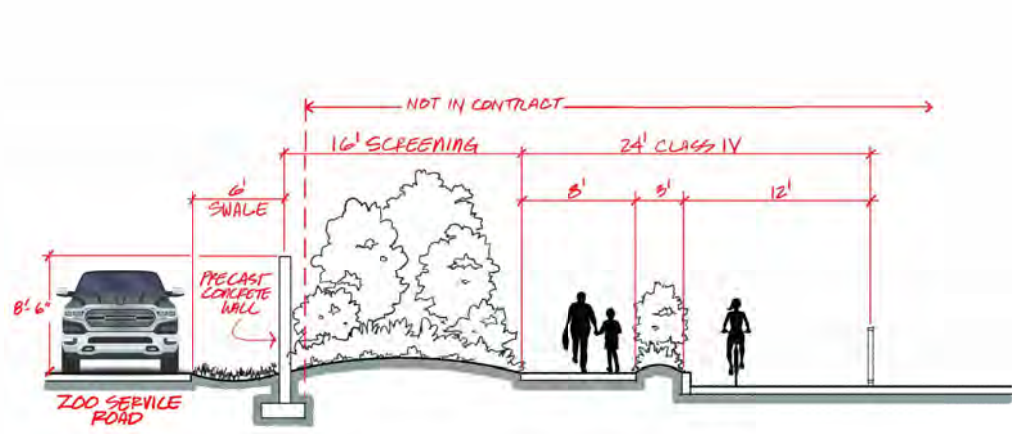

1 Perimeter Fence - B Street Section  
1/4" = 1'-0"

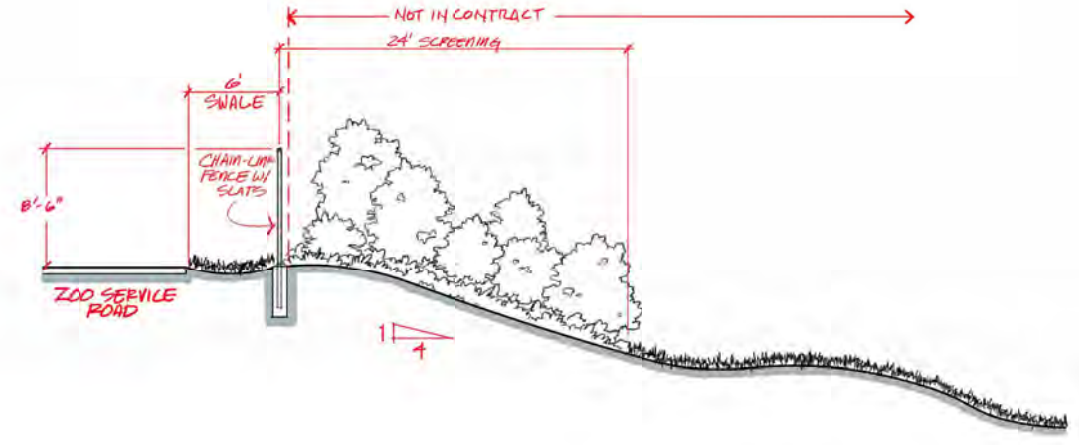

2 Perimeter Fence - Channel Section  
1/4" = 1'-0"

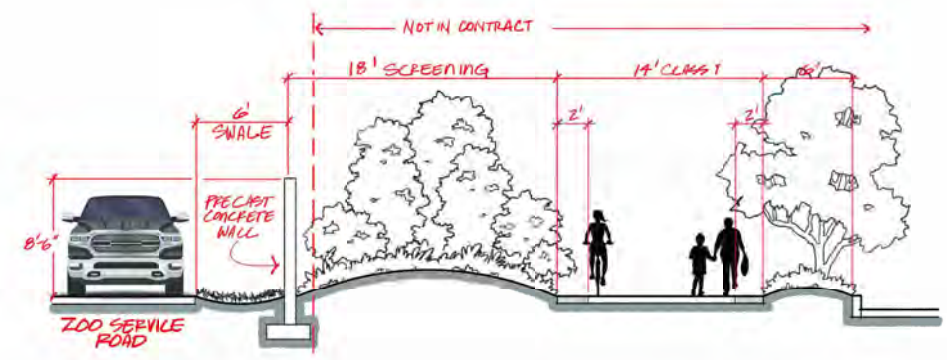

3 Perimeter Fence - Lotz Section  
1/4" = 1'-0"

REV DATE	DESCRIPTION
1 09/22/2023	For Review
2 10/06/2023	For Pricing

NOT FOR CONSTRUCTION

The New Zoo at Elk Grove

BARRIER DETAILS - PERIMETER FENCE

SHEET SIZE: ARCH E (36" x 48")  
DATE: 06 October 2023  
SCALE: 1/4" = 1'-0"  
CHECKED: SMK/mc  
SHEET:

X334

Schematic Plans



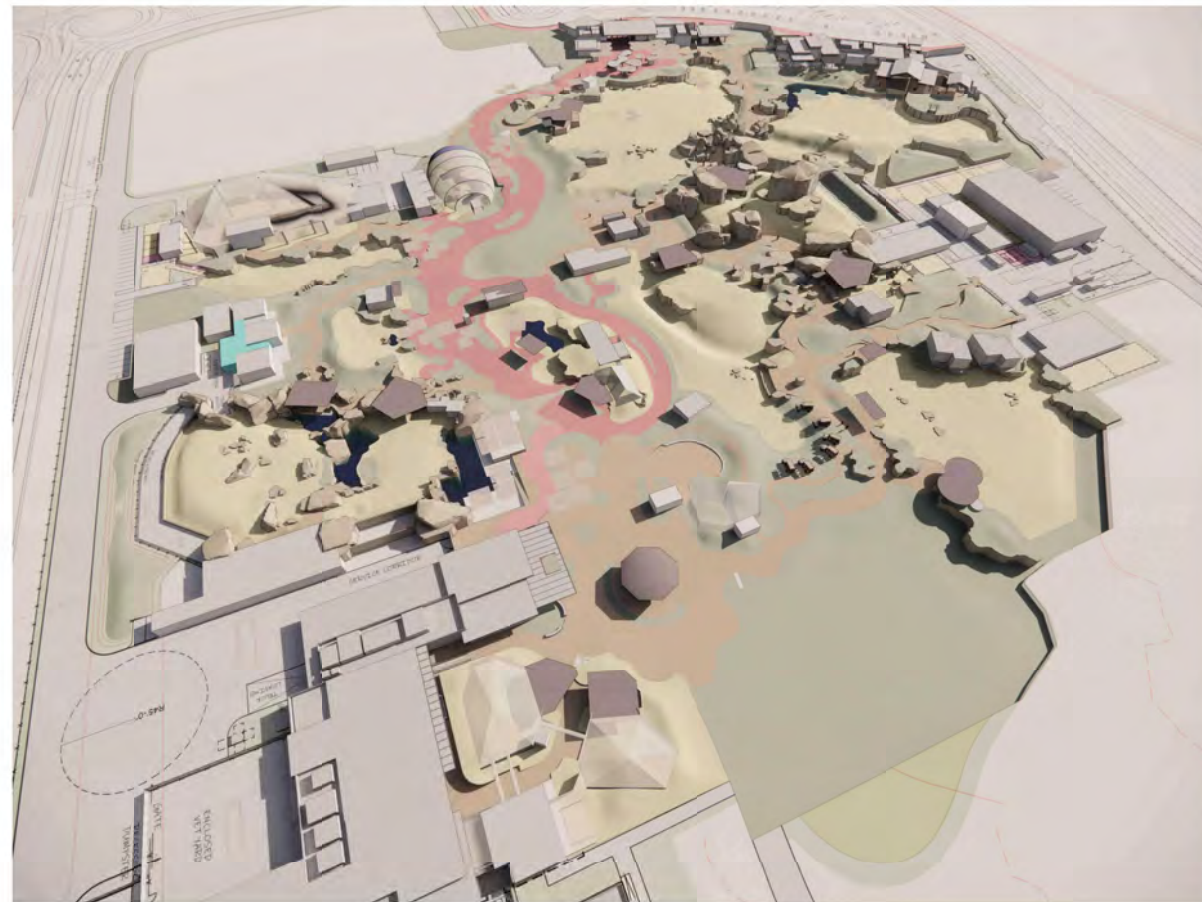
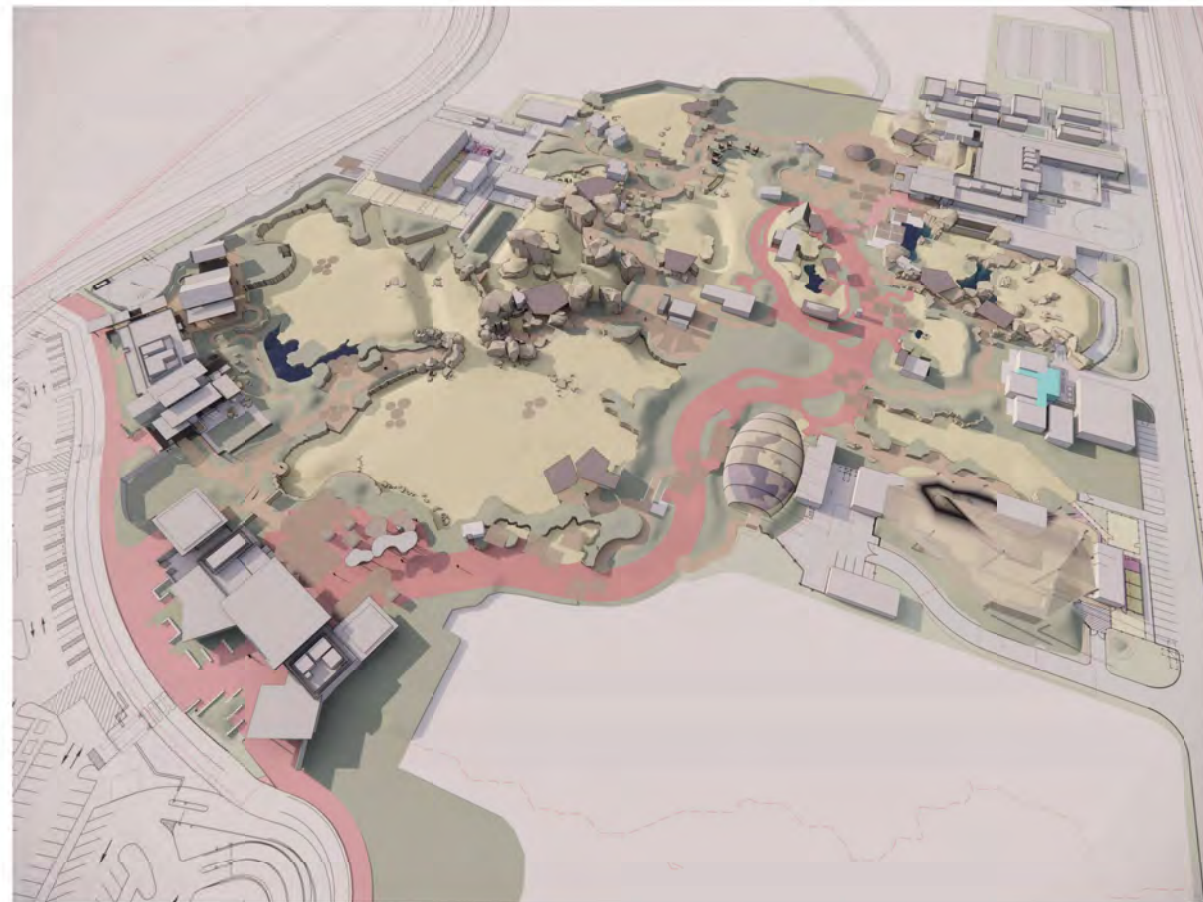
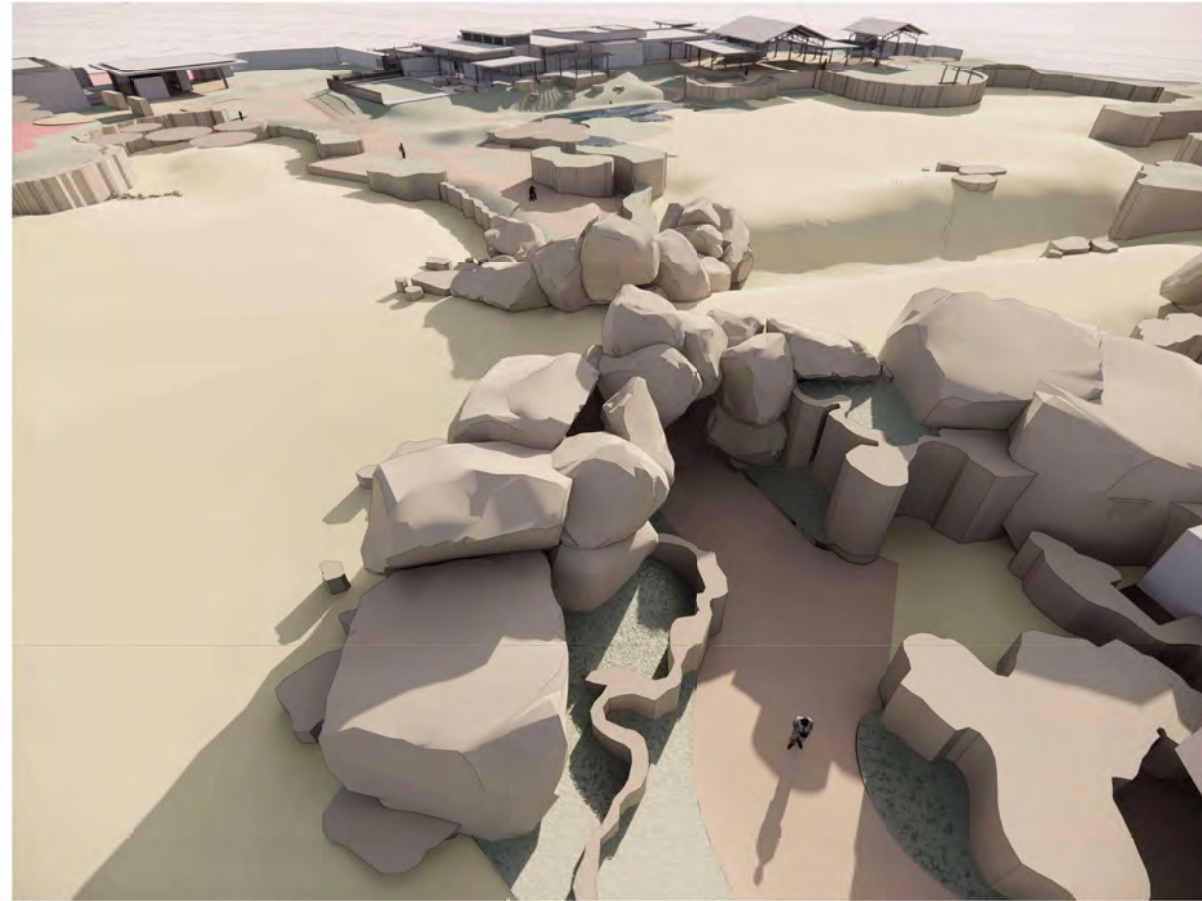
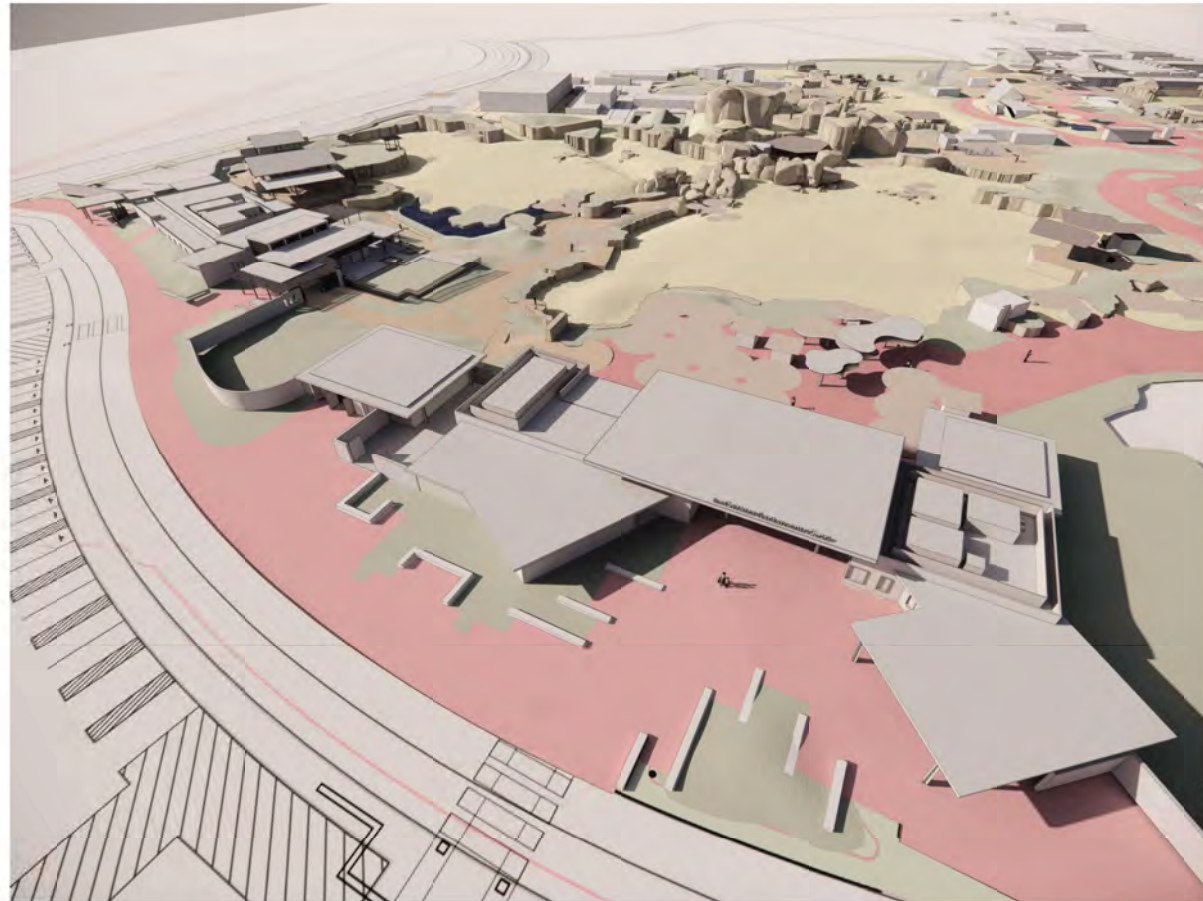

Sacramento Zoological Society  
3500 W. Land Park Drive  
Sacramento, CA USA



SH R Studios  
250 Madonna Way N.E. #220  
Bainbridge Island, WA 98110  
phone (206) 842-8332  
shrstudios.com

**NOLL & TAM**  
ARCHITECTS

Kimley **Horn**



REV DATE	DESCRIPTION
1 09/22/2023	For Review
2 10/06/2023	For Pricing

NOT FOR CONSTRUCTION

The New Zoo at Elk Grove

MODEL VIEWS

SHEET SIZE: ARCH E (36" x 48")  
DATE: 06 October 2023  
SCALE: 12" = 1'-0"  
CHECKED: SMK/Mc  
SHEET:

**X350**

Schematic Plans

PROPERTY OF SHR STUDIOS, INC. USE OF THIS DOCUMENT IS PROHIBITED WITHOUT THE WRITTEN CONSENT OF SHR STUDIOS, INC.



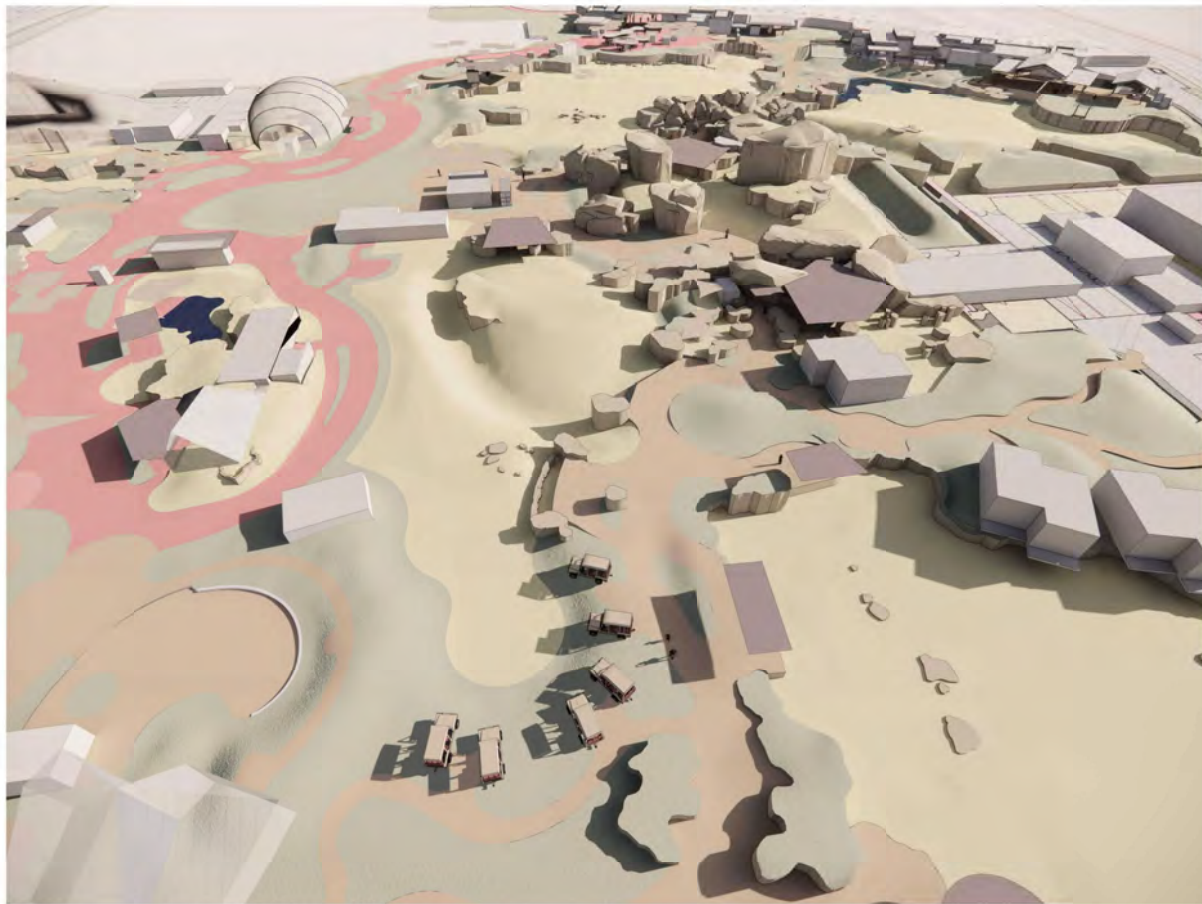
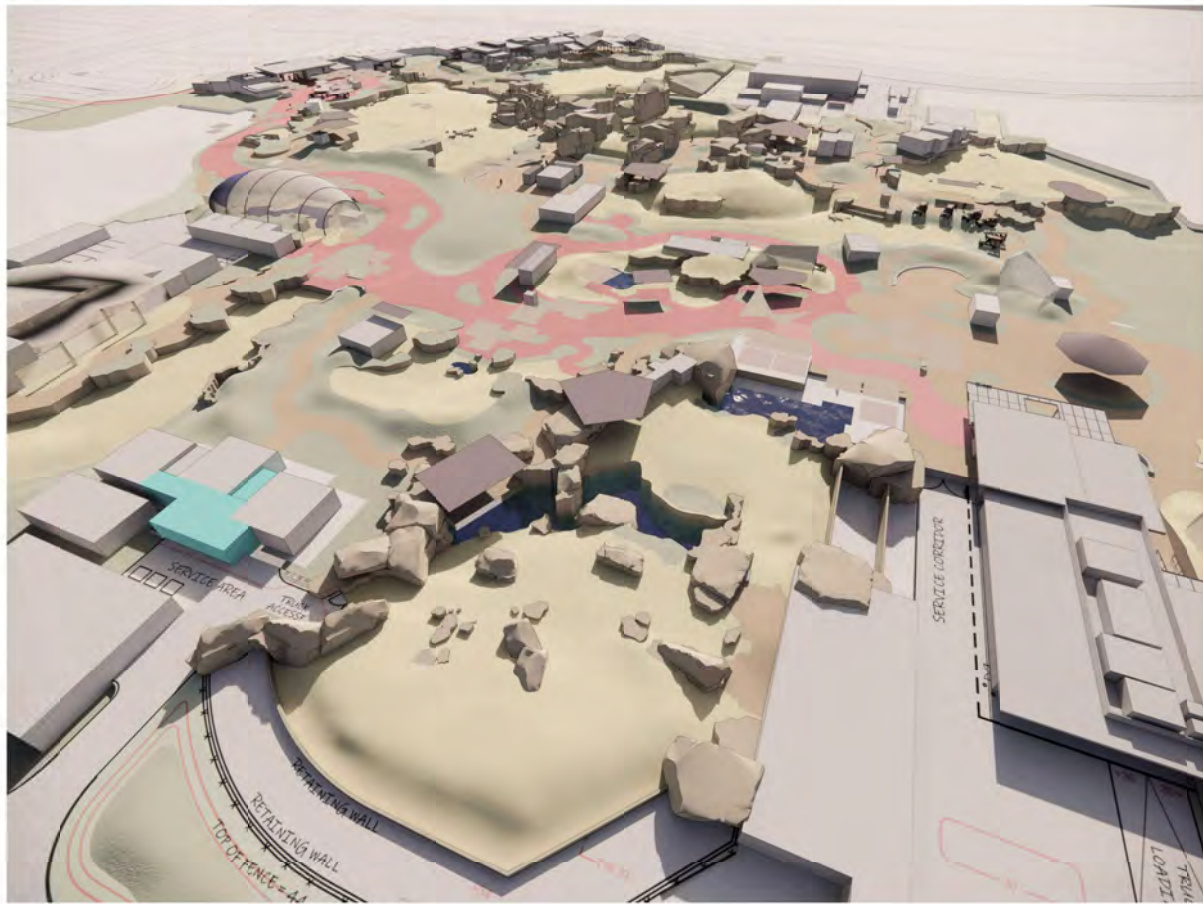
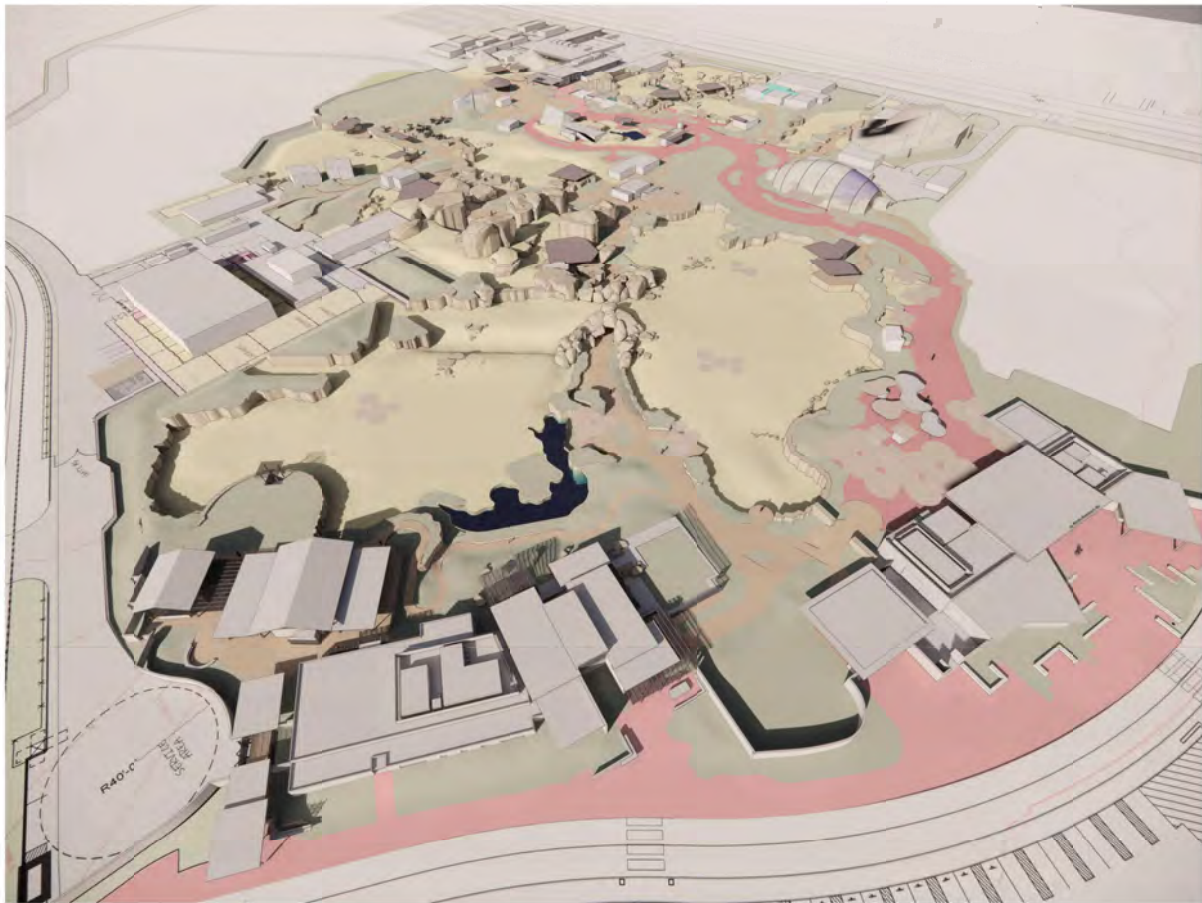
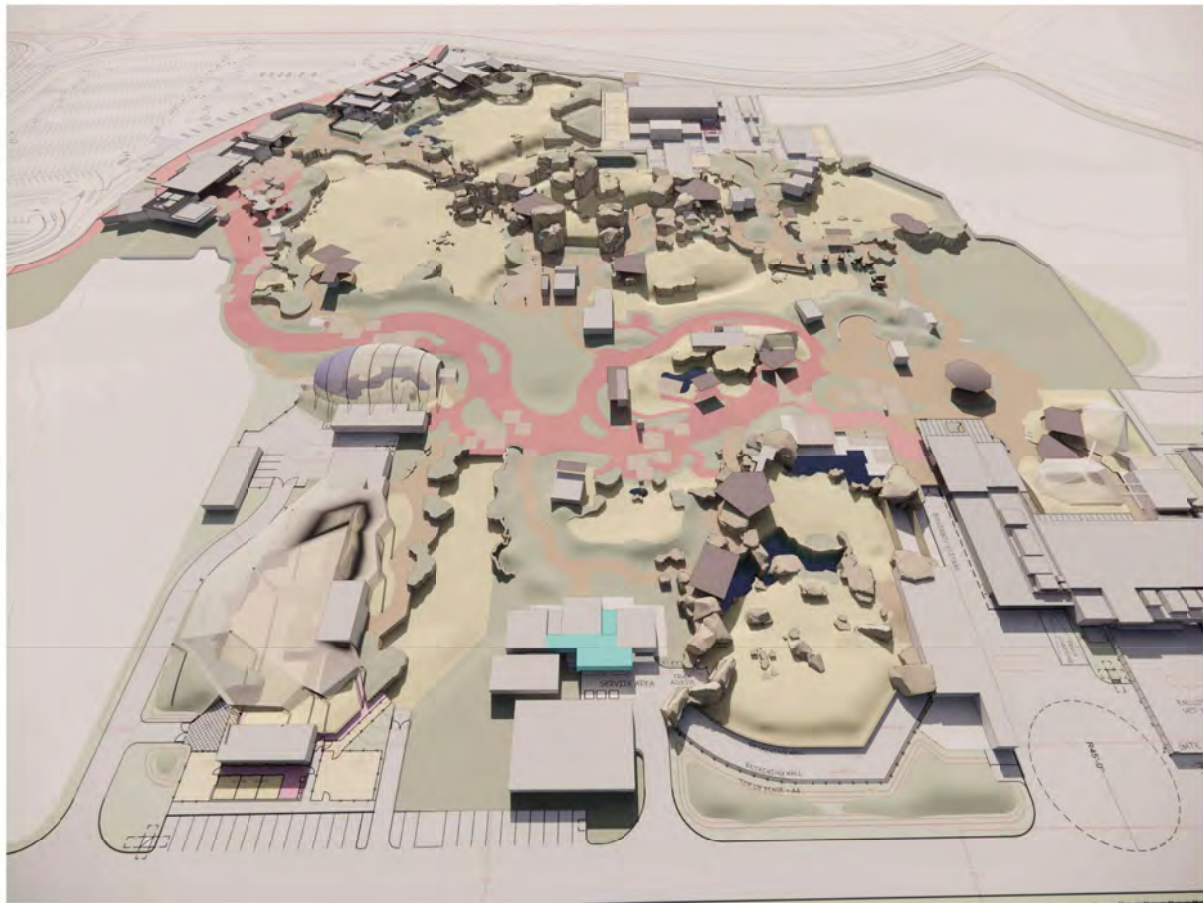

REV	DATE	DESCRIPTION
1	09/22/2023	For Review
2	10/06/2023	For Pricing

NOT FOR CONSTRUCTION

The New Zoo at Elk Grove

MODEL VIEWS

SHEET SIZE:	ARCH E (36" x 48")
DATE:	06 October 2023
SCALE:	12" = 1'-0"
CHECKED:	SMK/Mc
SHEET:	

X351

NOT DATE TIME

PROPERTY OF SHR STUDIOS, INC. USE OF PHOTOGRAPHS PROVIDED BY PHOTOGRAPHERS IS BY PERMISSION. ALL RIGHTS RESERVED.









REV	DATE	DESCRIPTION
1	09/22/2023	For Review
2	10/06/2023	For Pricing

NOT FOR CONSTRUCTION

The New Zoo at Elk Grove

IMAGE BOARD - CITY WALK

SHEET SIZE: ARCH E (36" x 48")  
DATE: 06 October 2023  
SCALE: 12" = 1'-0"  
CHECKED: SMK/MLC  
SHEET:

**X402**

Schematic Plans







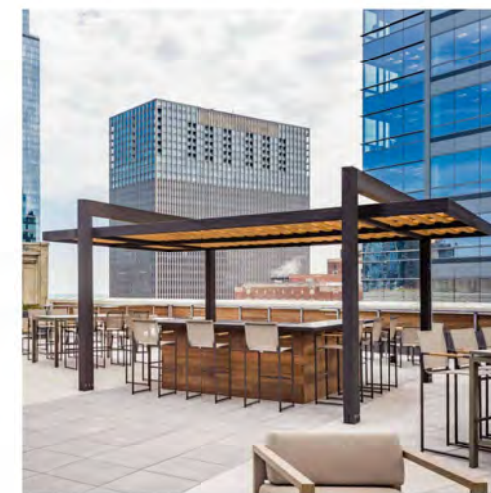

Sacramento Zoological Society  
3500 W. Land Park Drive  
Sacramento, CA USA



SHR Studios  
250 Madison Way N.E. #220  
Bainbridge Island, WA 98110  
phone (206) 842 8332  
shrstudios.com

**NOLL  
& TAM**  
ARCHITECTS

Kimley **Horn**



REV	DATE	DESCRIPTION
1	09/22/2023	For Review
2	10/06/2023	For Pricing

NOT FOR CONSTRUCTION

The New Zoo at Elk Grove

IMAGE BOARD - GREEN  
CORRIDOR

SHEET SIZE: ARCH E (36" x 48")  
DATE: 06 October 2023  
SCALE: 1/2" = 1'-0"  
CHECKED: SMK/mc  
SHEET:

**X404**

Schematic Plans











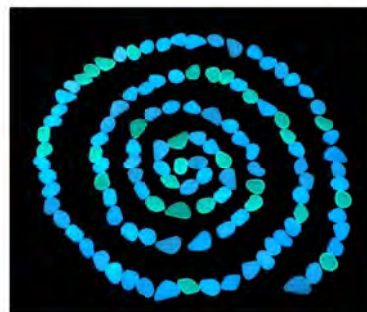
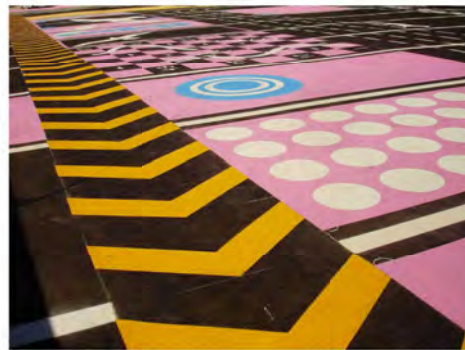

Sacramento Zoological Society  
3500 W. Land Park Drive  
Sacramento, CA USA



SH R Studios  
250 Madonna Way N.E. #220  
Bainbridge Island, WA 98110  
phone (206) 842-8332  
shrstudios.com

NOLL  
& TAM  
ARCHITECTS

Kimley»Horn



REV	DATE	DESCRIPTION
1	09/22/2023	For Review
2	10/06/2023	For Pricing

NOT FOR CONSTRUCTION

The New Zoo at Elk Grove

IMAGE BOARD - THE PLAY ZONE

SHEET SIZE: ARCH E (36" x 48")  
DATE: 06 October 2023  
SCALE: 1/2" = 1'-0"  
CHECKED: SMK/mc  
SHEET:

X407

Schematic Plans

PROPERTY OF SHR STUDIOS, INC. USE OF PHOTOGRAPHS PROVIDED BY PHOTOGRAPHERS IS SOLELY FOR ILLUSTRATIVE PURPOSES. ALL RIGHTS RESERVED.







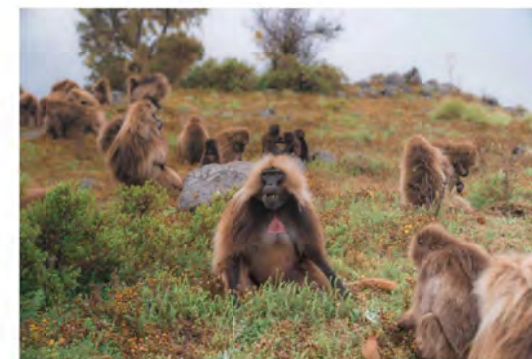

REV	DATE	DESCRIPTION
1	09/22/2023	For Review
2	10/06/2023	For Pricing

NOT FOR CONSTRUCTION

The New Zoo at Elk Grove

IMAGE BOARD - GELADA

SHEET SIZE: ARCH E (36" x 48")  
DATE: 06 October 2023  
SCALE: 12" = 1'-0"  
CHECKED: SMK/klc  
SHEET:

X409

Schematic Plans



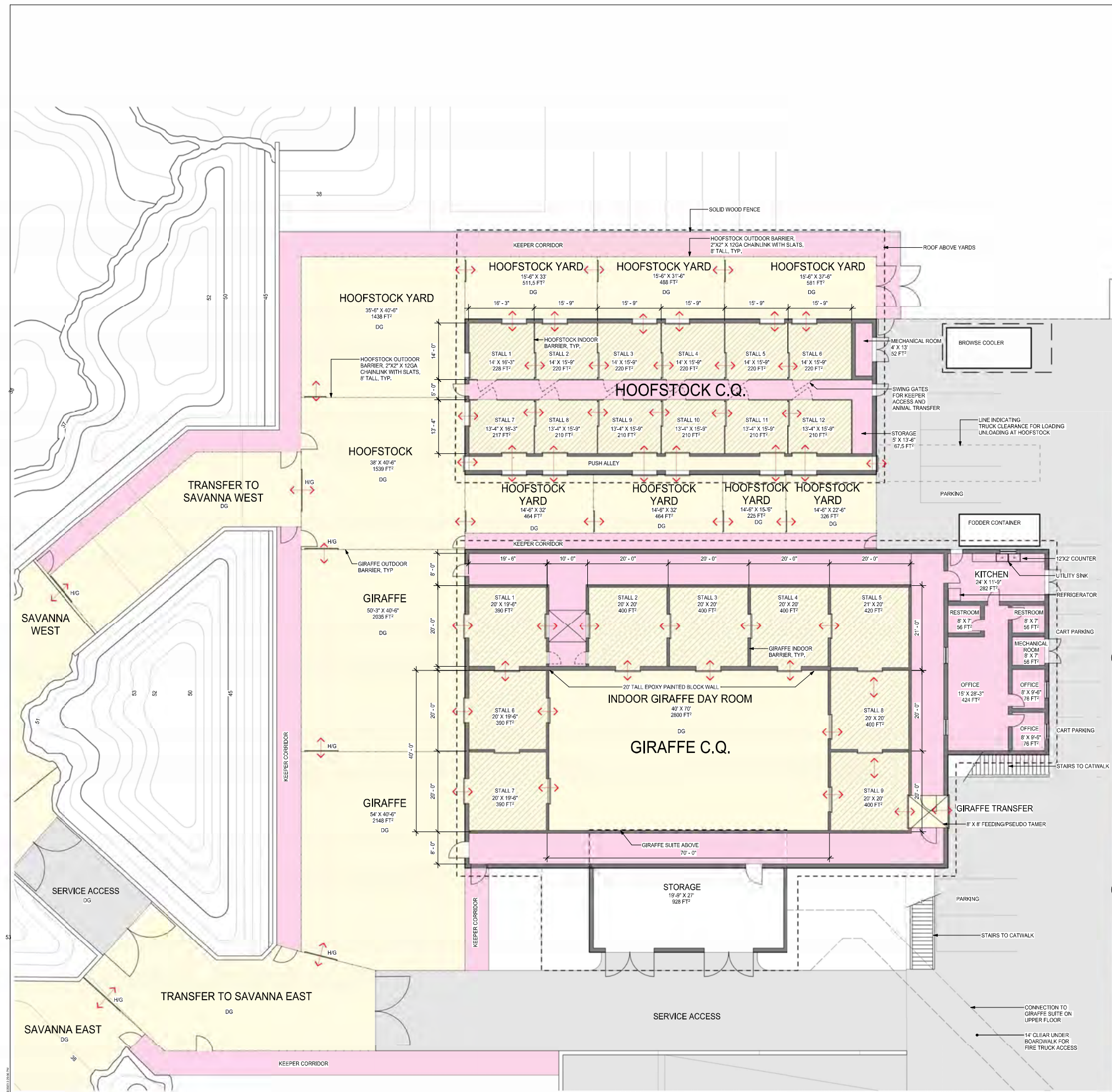

**LEGEND**

- RUBBER FLOORING
- RUBBERIZED FLOORING WITH HEAT
- DG DECOMPOSED GRANITE
- HG GIRAFFE GATE WITH CROSSBAR



2 Giraffe Indoor Barrier  
NTS



3 Giraffe Outdoor Barrier  
NTS



4 Hoofstock Indoor Barrier  
NTS

REV DATE	DESCRIPTION
1 09/22/2023	For Review
2 10/06/2023	For Pricing

NOT FOR CONSTRUCTION

The New Zoo at Elk Grove

PHASE 1 CARE QUARTERS PLANS

SHEET SIZE:	ARCH E (36" x 48")
DATE:	06 October 2023
SCALE:	As indicated
CHECKED:	SMK/Mc
SHEET:	

**X701**

Schematic Plans

1 Giraffe and Hoofstock Care Quarters  
1/8" = 1'-0"

PROPERTY OF SHR STUDIOS, INC. USE OF THIS DOCUMENT FOR ANY OTHER PROJECT WITHOUT THE WRITTEN PERMISSION OF SHR STUDIOS, INC. IS PROHIBITED.



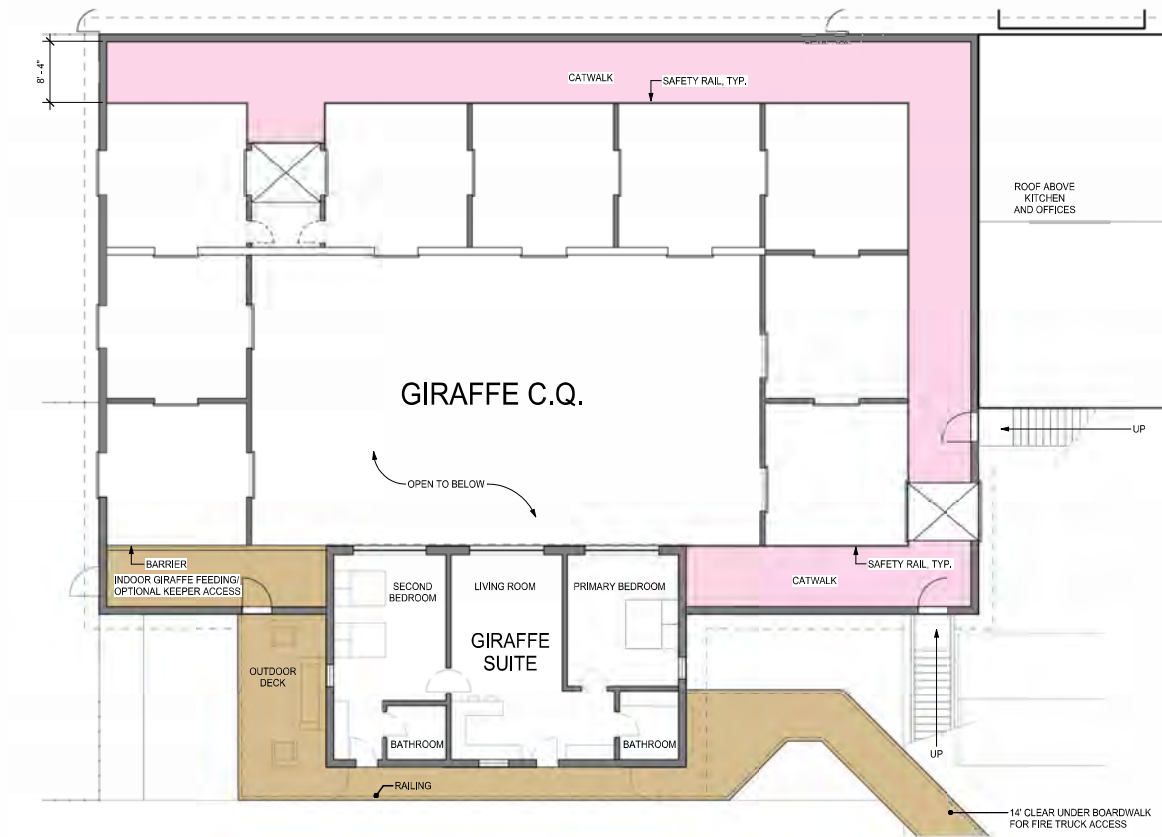

1 Giraffe Care Quarters- Second level  
1/8" = 1'-0"



Sacramento Zoological Society  
3500 W. Land Park Drive  
Sacramento, CA USA



SHR Studios  
250 Madison Way N.E. #220  
Bainbridge Island, WA 98110  
phone (206) 842-8332  
shrstudios.com

**NOLL & TAM**  
ARCHITECTS

Kimley»Horn



REV	DATE	DESCRIPTION
1	09/22/2023	For Review
2	10/06/2023	For Pricing

NOT FOR CONSTRUCTION

The New Zoo at Elk Grove

PHASE 1 CARE QUARTERS  
PLANS

SHEET SIZE: ARCH E (36" x 48")  
DATE: 06 October 2023  
SCALE: 1/8" = 1'-0"  
CHECKED: SMK/mc  
SHEET:

**X702**

Schematic Plans





SHR Studios  
250 Madison Way N.E. #220  
Bainbridge Island, WA 98110  
phone (206) 842 8332  
shrstudios.com

**NOLL & TAM**  
ARCHITECTS

KimleyHorn



REV. DATE	DESCRIPTION
1 09/22/2023	For Review
2 10/06/2023	For Pricing

NOT FOR CONSTRUCTION

The New Zoo at Elk Grove

PHASE 1 CARE QUARTERS PLANS

SHEET SIZE: ARCH E (36" x 48")  
DATE: 06 October 2023  
SCALE: As indicated  
CHECKED: SMK/ML  
SHEET:

**X703**

Schematic Plans

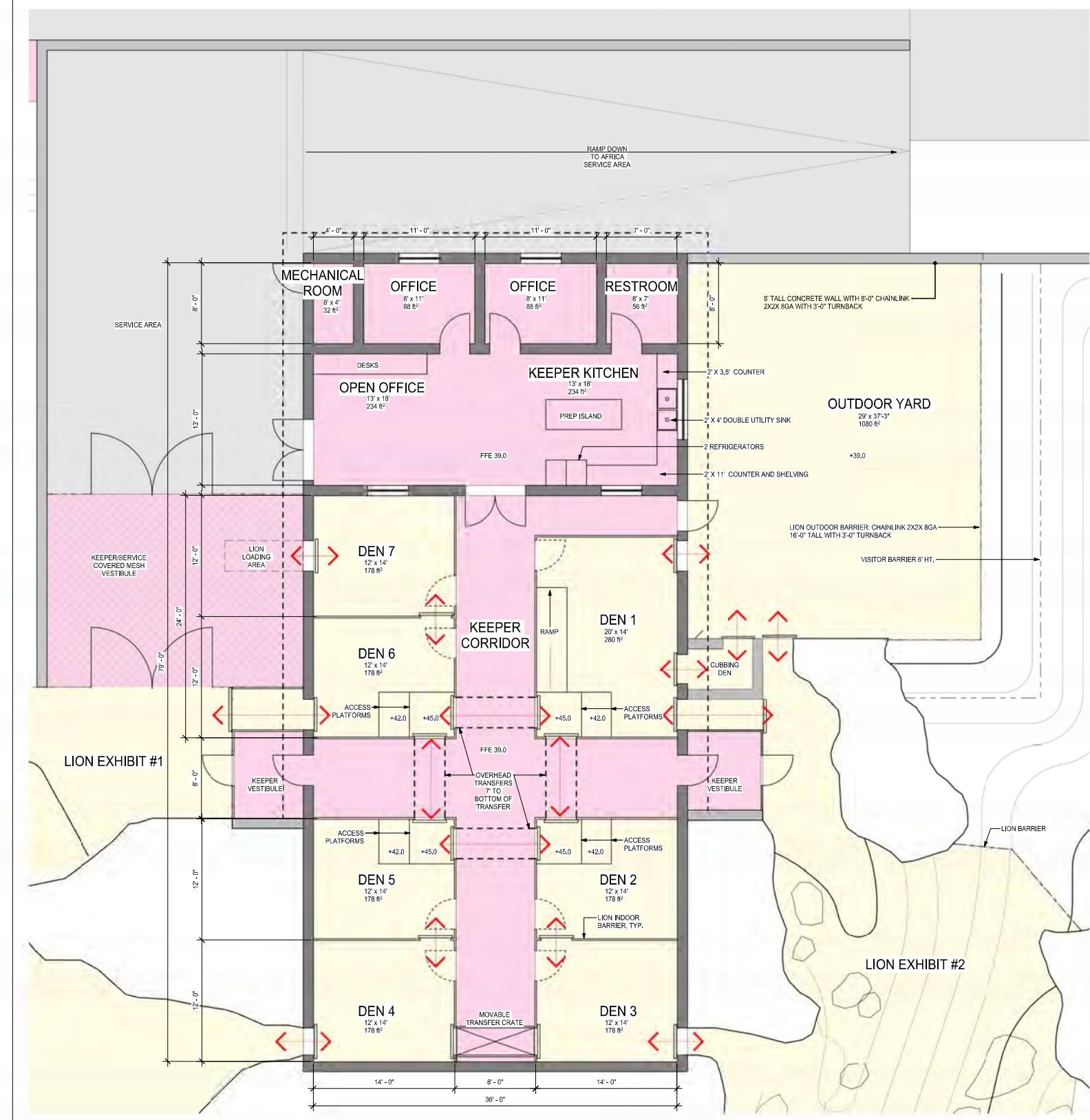

1 Lion Care Quarters  
1/4" = 1'-0"



3 Lion Indoor Barrier  
NTS



4 Lion Overhead Transfer  
1" = 1'-0"

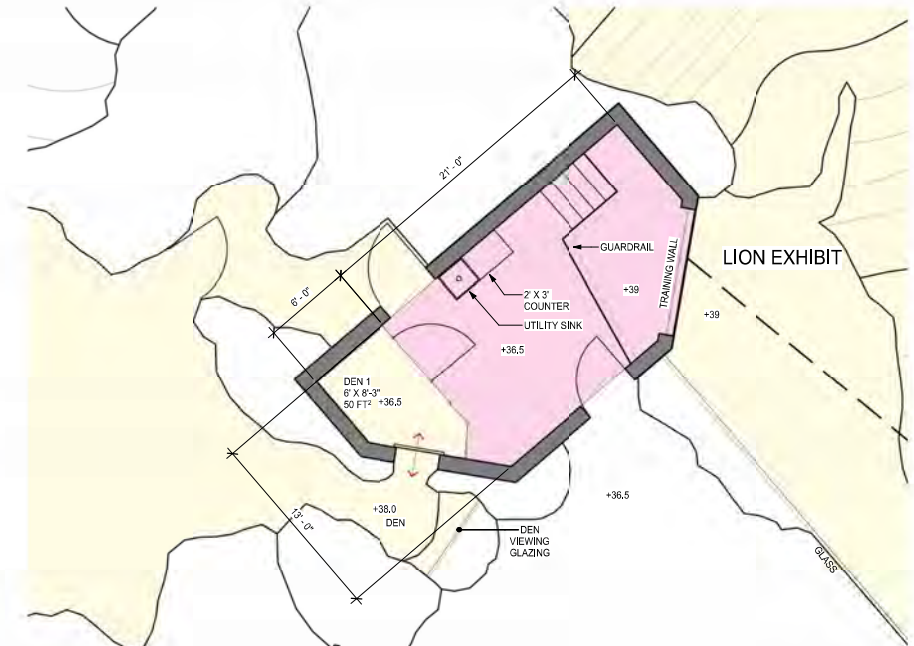

2 African Small Animal Care Quarters  
1/4" = 1'-0"







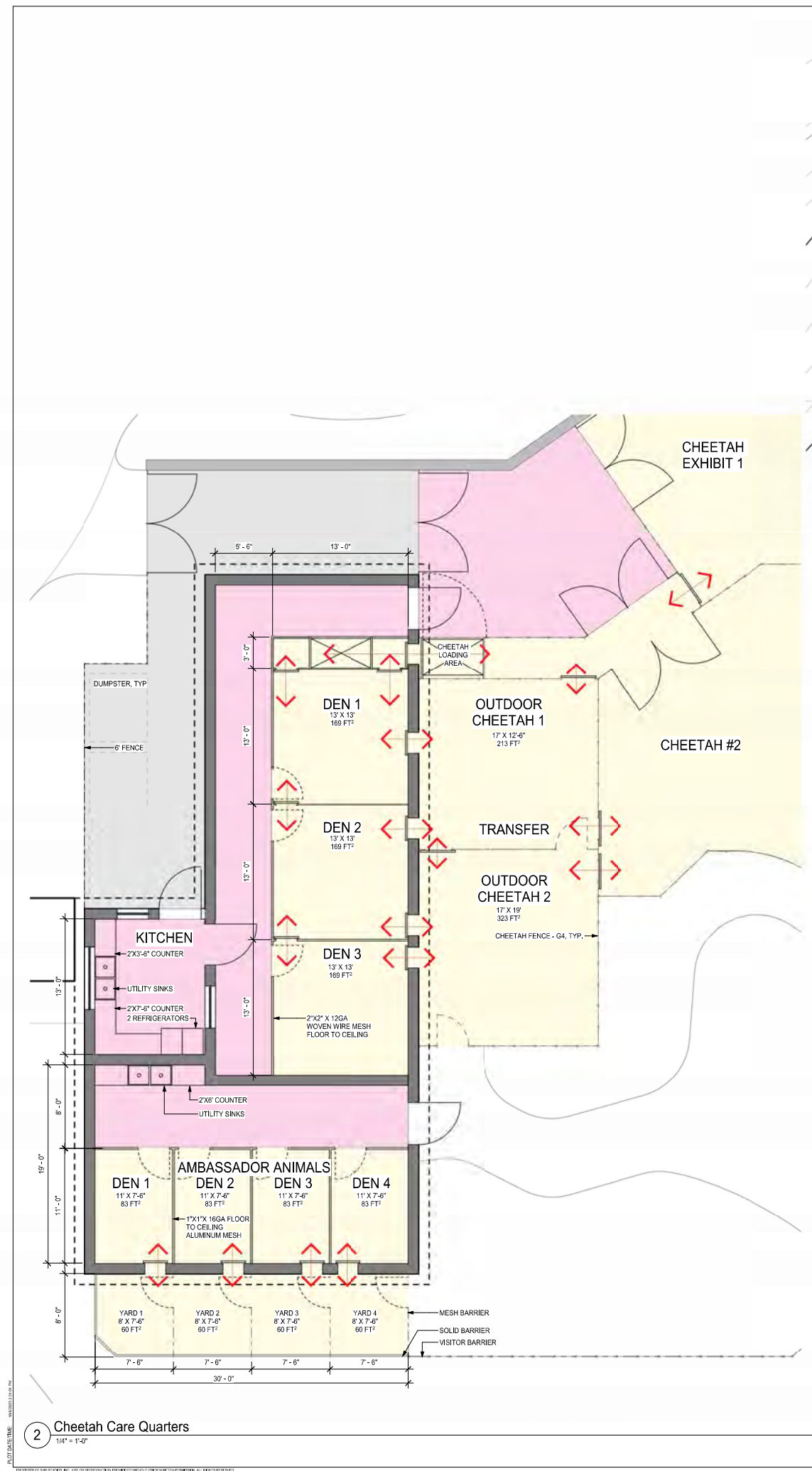

2 Cheetah Care Quarters  
1/4" = 1'-0"

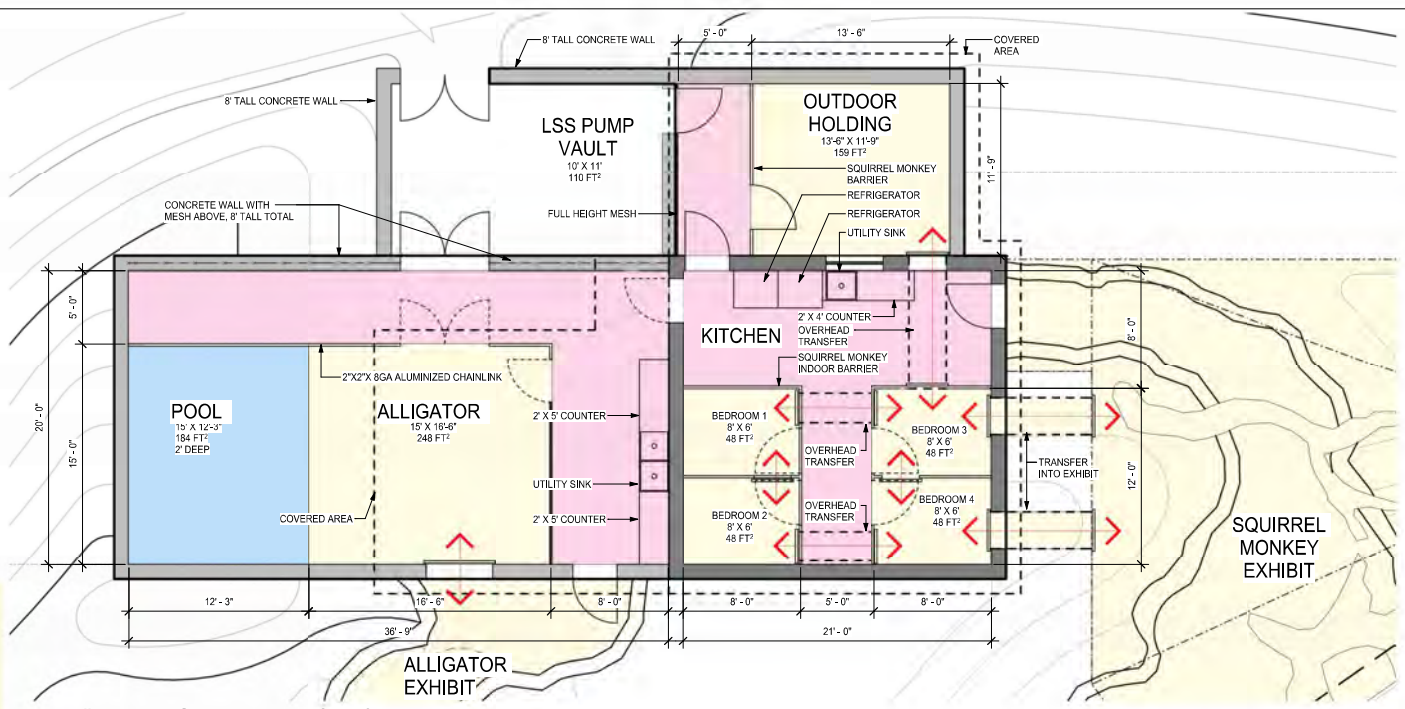

1 Alligator and Squirrel Monkey Care Quarters and Filtration  
1/4" = 1'-0"

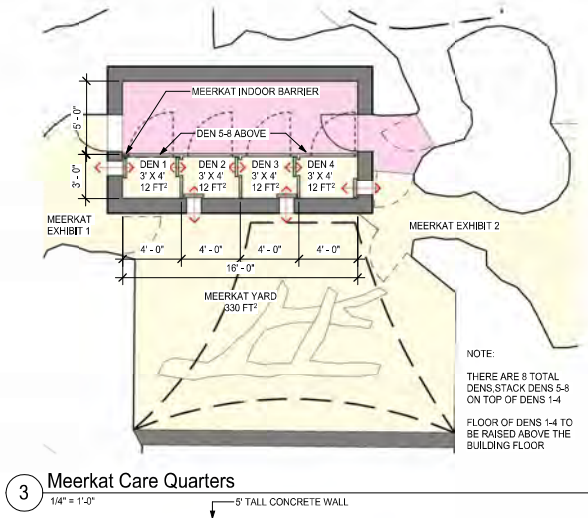

3 Meerkat Care Quarters  
1/4" = 1'-0"



4 Squirrel Monkey and Meerkat Indoor Barrier  
1" = 1'-0"

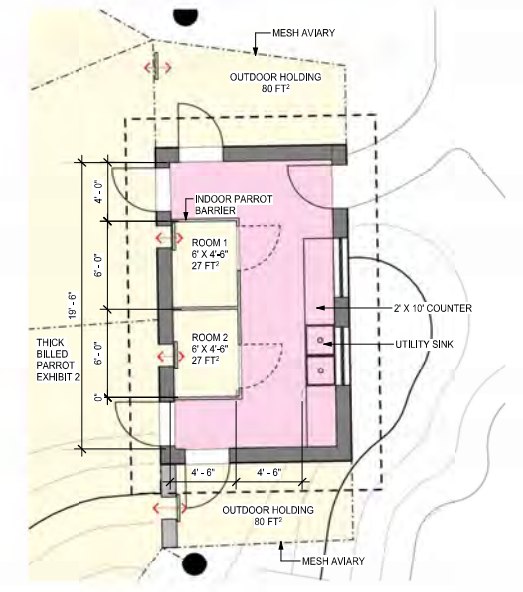

5 Parrot Care Quarters  
1/4" = 1'-0"



6 Indoor Parrot Barrier  
1" = 1'-0"

REV	DATE	DESCRIPTION
1	09/22/2023	For Review
2	10/06/2023	For Pricing

NOT FOR CONSTRUCTION

The New Zoo at Elk Grove

PHASE 1 CARE QUARTERS  
PLANS

SHEET SIZE: ARCH E (36" x 48")  
DATE: 06 October 2023  
SCALE: As indicated  
CHECKED: SMK/Mc  
SHEET:

X705

Schematic Plans







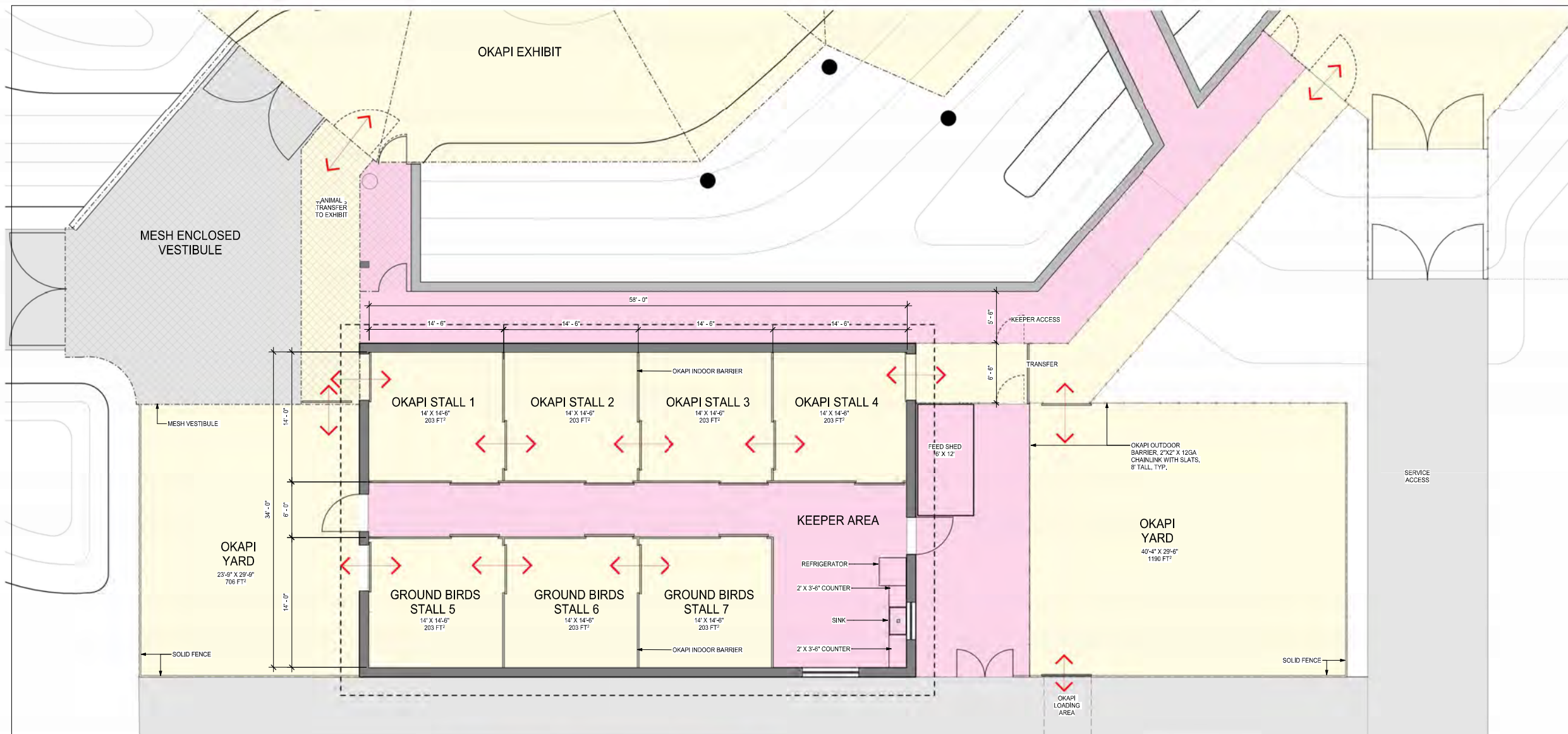

1 Okapi and Ground Bird Care Quarters  
1/4" = 1'-0"

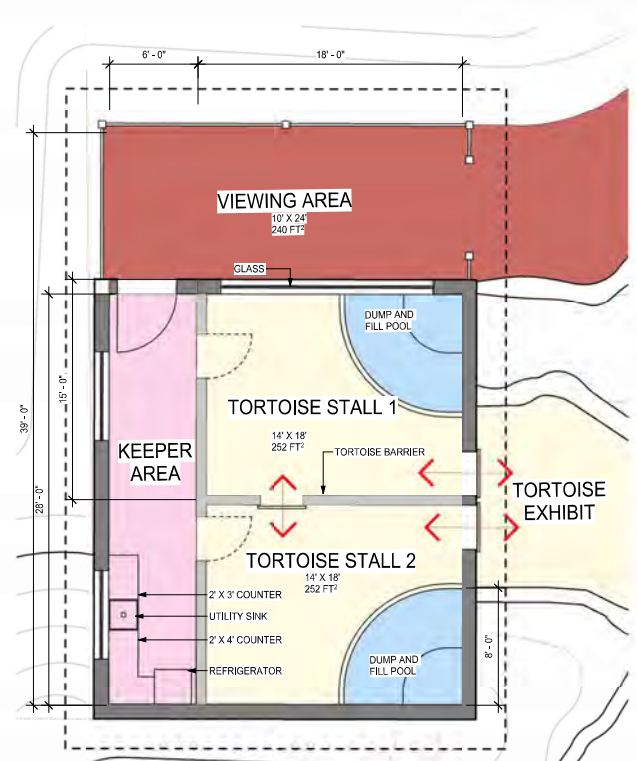

2 Giant Tortoise Care Quarters  
1/4" = 1'-0"



3 Okapi Indoor Barrier  
1" = 1'-0"



4 Tortoise Barrier  
1" = 1'-0"

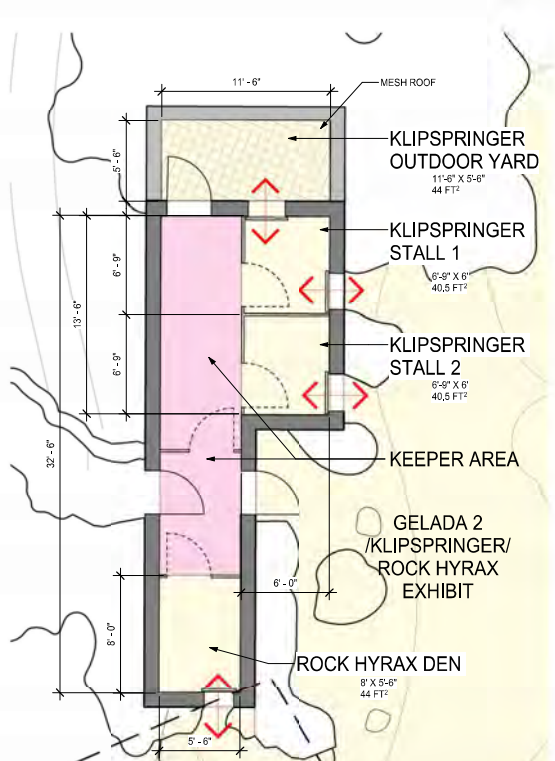

5 Klipspringer, Hyrax Care Quarters  
1/4" = 1'-0"



6 Klipspringer and Hyrax Indoor Barrier  
1" = 1'-0"

REV DATE	DESCRIPTION
1 09/22/2023	For Review
2 10/06/2023	For Pricing

NOT FOR CONSTRUCTION

The New Zoo at Elk Grove

PHASE 1 CARE QUARTERS  
PLANS

SHEET SIZE: ARCH E (36" x 48")  
DATE: 06 October 2023  
SCALE: As indicated  
CHECKED: SMK/Mc  
SHEET:

X707

Schematic Plans

PROPERTY OF SHR STUDIOS, INC. USE OF THIS DOCUMENT IS PROHIBITED WITHOUT WRITTEN PERMISSION. ALL RIGHTS RESERVED.



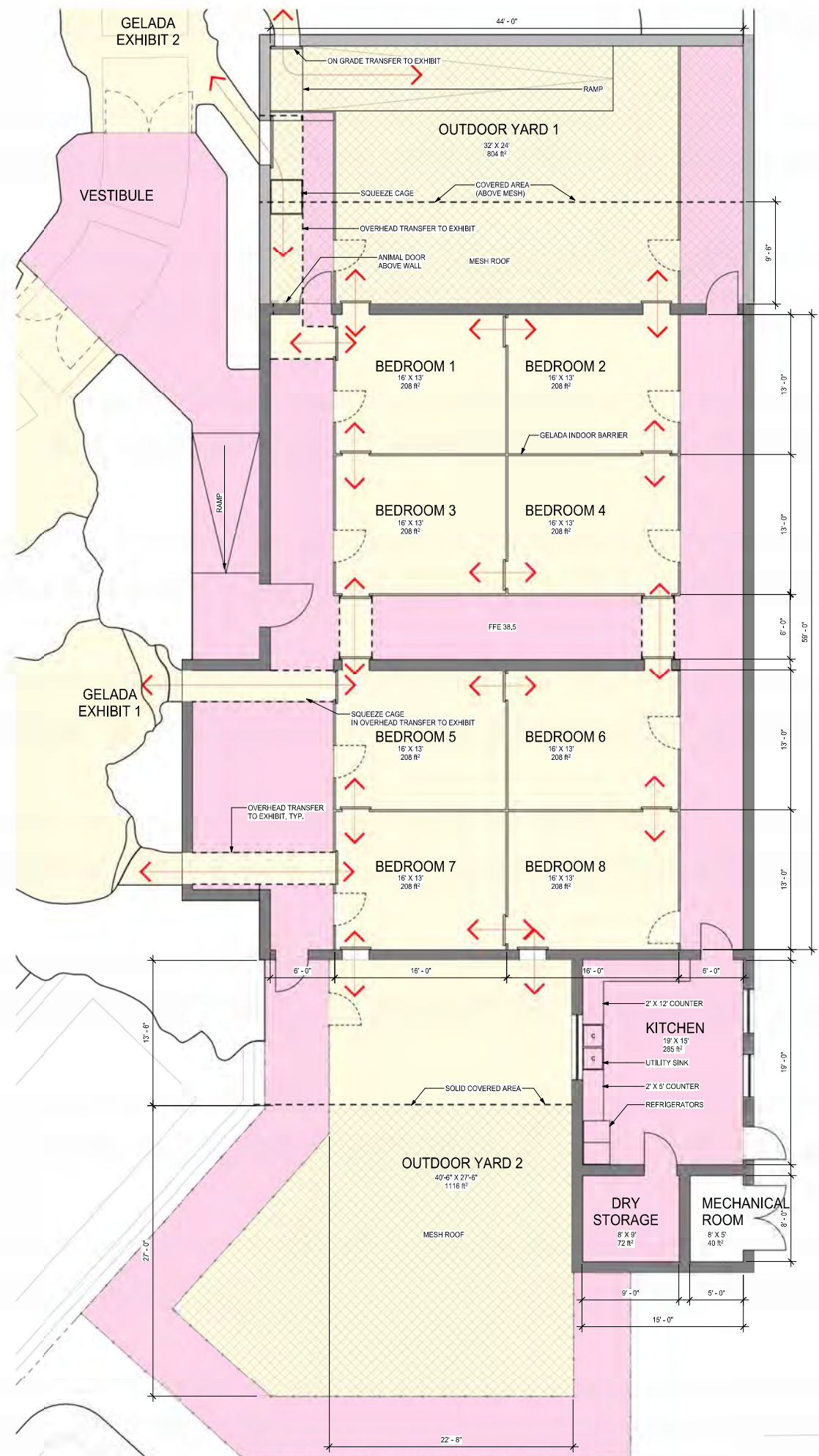

1 Gelada Care Quarters  
1/4" = 1'-0"

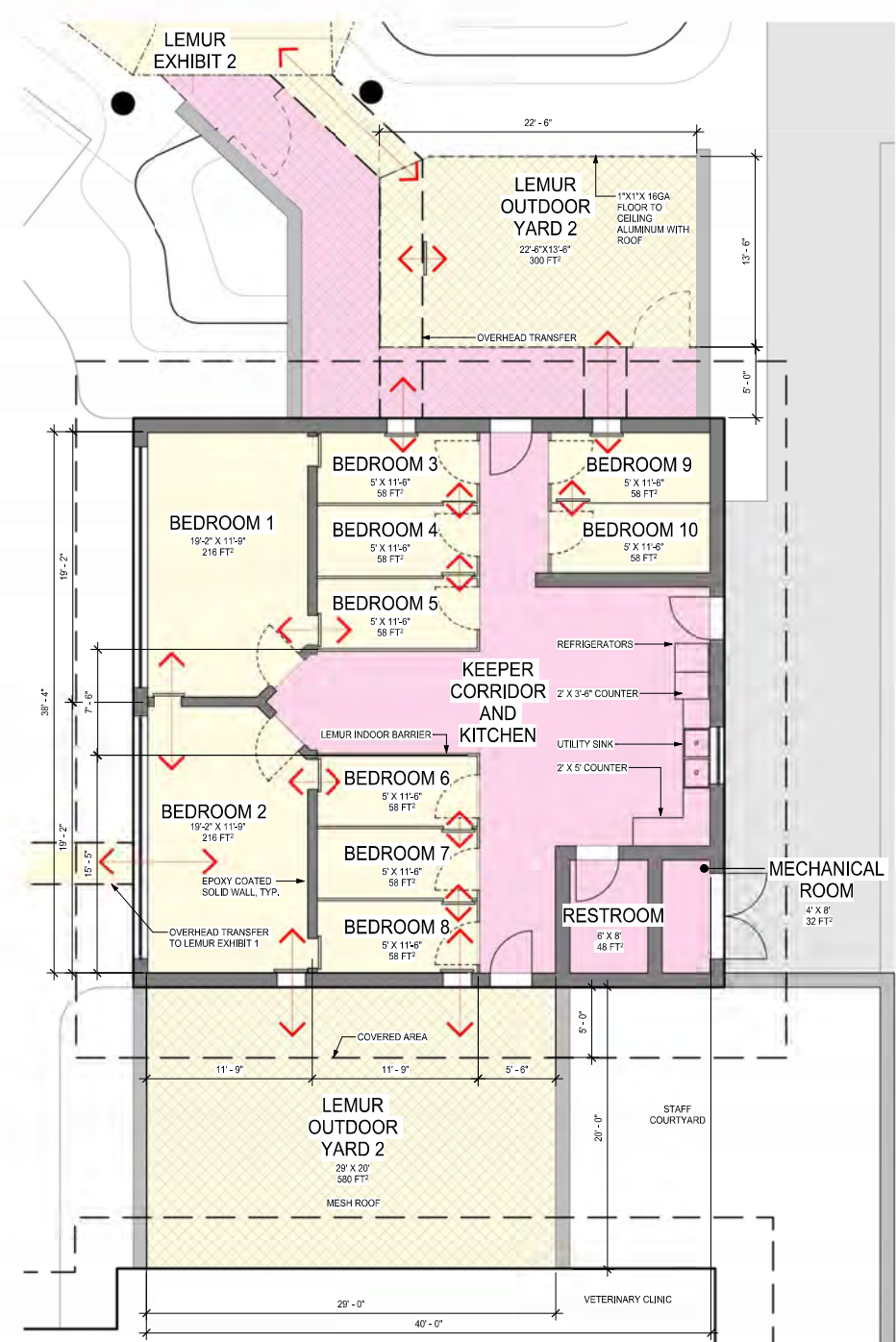

2 Lemur Care Quarters  
1/4" = 1'-0"



3 Gelada Indoor Barrier  
1" = 1'-0"



4 Lemur Indoor Barrier  
1" = 1'-0"

REV	DATE	DESCRIPTION
1	09/22/2023	For Review
2	10/06/2023	For Pricing

NOT FOR CONSTRUCTION

The New Zoo at Elk Grove

PHASE 1 CARE QUARTERS PLANS

SHEET SIZE: ARCH E (36" x 48")  
DATE: 06 October 2023  
SCALE: As indicated  
CHECKED: SMK/mc  
SHEET:

**X708**

Schematic Plans