

Improvement Standards Manual



Amended by City Engineer on June 22, 2020

A handwritten signature in blue ink, appearing to read "R. Murdoch", is positioned above a horizontal line.

Robert Murdoch, P.E.
Public Works Director/City Engineer

**CITY OF ELK GROVE
IMPROVEMENT STANDARDS
TABLE OF CONTENTS**

SECTION 1 PURPOSE AND DEFINITIONS

1-1. PURPOSE 1

1-2. RELATIONSHIP TO OTHER CITY-ADOPTED PLANS AND POLICIES 1

1-3. OTHER AGENCY COORDINATION..... 2

1-4. OMISSIONS 2

1-5. DEFINITIONS 2

SECTION 2 GENERAL PROCEDURES AND REQUIREMENTS

2-1. ENGINEER REQUIRED 4

2-2. PLANS REQUIRED 4

2-3. WORK IN CITY RIGHTS-OF-WAY, EASEMENTS AND WATERWAYS 4

2-4. PRELIMINARY PLAN SUBMITTAL REQUIREMENTS (ENTITLEMENTS) 4

2-5. IMPROVEMENT PLAN SUBMITTAL REQUIREMENTS 5

2-6. MAPPING SUBMITTAL REQUIREMENTS 6

2-7. RESUBMITTAL REQUIREMENTS 6

2-8. PLAN REVIEW AND INSPECTION FEE 6

2-9. PLAN APPROVAL 7

2-10. APPROVED PLANS REQUIRED 7

2-11. IMPROVEMENT PLAN REVISIONS DURING CONSTRUCTION 7

2-12. RECORD DRAWINGS..... 8

2-13. DEVIATION FROM STANDARDS 9

2-14. CONFLICTS, ERRORS AND OMISSIONS 9

2-15. CHANGE IN CONSULTING ENGINEER 9

2-16. BORING AND JACKING SAFETY REQUIREMENTS 10

2-17. UTILITIES 10

2-18. PARTIAL PLANS 11

2-19. OTHER AGENCY NOTIFICATIONS 11

2-20. INSPECTION REQUIREMENTS 12

2-21. COMMERCIAL / PRIVATE PROPERTY INSPECTION REQUIREMENTS 12

2-22. SPECIAL NOTICES AND PERMITS..... 12

SECTION 3 IMPROVEMENT PLAN REQUIREMENTS

3-1	ELECTRONIC SUBMITTALS	14
3-2	PAPER SIZE AND SCALE	14
3-3	DRAFTING STANDARD.....	14
3-4	TITLE SHEET	14
3-5	TITLE BLOCK.....	15
3-6	DRAINAGE, SEWER, WATER, SIGNING AND STRIPING AND GRADING LAYOUT.....	15
3-7	PLAN DETAILS	15
3-8	REQUIRED NOTES	18
3-9	STANDARD DRAWINGS	18

SECTION 4 STREETS

4-1.	DEVELOPER'S PAVEMENT, SIGNAL, AND STREET LIGHT RESPONSIBILITY	19
4-2.	CITY COST PARTICIPATION	20
4-3.	STREET DESIGN STANDARDS	21
4-4.	STANDARD PLANS.....	25
4-5.	STRUCTURAL SECTION	25
4-6.	HORIZONTAL AND VERTICAL STANDARDS	26
4-7.	INTERSECTIONS AND DRIVEWAYS	27
4-8.	SIGHT DISTANCE AND VISIBILITY EASEMENTS AT INTERSECTIONS.....	30
4-10.	CUL-DE-SAC	31
4-11.	PARTIAL STREET	31
4-12.	BUS STOP	32
4-13.	SIDEWALK RAMP AND ACCESSIBILITY IMPROVEMENTS	33
4-14.	CURB AND GUTTER	34
4-15.	CROSS GUTTER.....	34
4-16.	BARRIER CURB	34
4-17.	SIDEWALKS	35
4-18.	PEDESTRIAN LANES AND TRAILS.....	36
4-19.	TRENCHING IN EXISTING PAVED ROADWAYS	36
4-20.	TESTING OF MATERIAL.....	36
4-21.	STREET NAME	36
4-22.	STREET SIGN LOCATION	37
4-23.	TRAFFIC SIGNS	38
4-24.	PERMANENT BARRICADE	38
4-25.	FENCES	39
4-26.	PRIVATELY OWNED BRIDGE	39
4-27.	VEHICLE ACCESS AT STREET TERMINATIONS	39
4-28.	TRAFFIC CALMING DEVICES.....	40

4-29.	ROOT BARRIERS	40
SECTION 5 STREET LIGHT DESIGN		
5-1.	STREET LIGHTS REQUIRED	41
5-2.	STREET LIGHTS NOT REQUIRED	41
5-3.	APPLICANT’S RESPONSIBILITY	41
5-4.	UTILITY COMPANY AUTHORIZATION	42
5-5.	GENERAL PLAN DETAILS	42
5-6.	DESIGN STANDARDS	42
5-7.	STREET LIGHT TYPE	42
5-8.	STREET LIGHT DESIGN DETAILS	44
5-9.	LAYOUT PLANNING	46
SECTION 6 SOUND BARRIER DESIGN		
6-1.	LOCATION REQUIREMENTS	48
6-2.	DESIGN	48
6-3.	PLAN REQUIREMENTS	48
6-4.	MAINTENANCE FUNDING.....	48
SECTION 7 TRAFFIC IMPACT ANALYSIS GUIDELINES		
7-1.	INTRODUCTION.....	49
SECTION 8 RESERVED FOR FUTURE USE		
SECTION 9 STORM DRAINAGE DESIGN		
9-1.	CITY POLICY AND REQUIREMENTS	51
9-2.	STORMWATER UTILITY	52
9-3.	DEFINITIONS	52
9-4.	FEDERAL EMERGENCY MANAGEMENT AGENCY (FEMA) FLOOD PROGRAM	54
9-5.	DRAINAGE FEES AND CREDITS.....	54
9-6.	IMPACTS TO EXISTING DRAINAGE	54
9-7.	LOCATION OF FACILITIES AND LAND DEDICATIONS	55
9-8.	DRAINAGE DESIGN CAPACITY.....	56
9-9.	DESIGN SUBMITTALS.....	56
9-10.	DESIGN RUNOFF	57
9-11.	HYDRAULICS	59
9-12.	CLOSED CONDUITS.....	66
9-13.	MANHOLES & JUNCTION BOXES	70
9-14.	INLETS.....	72
9-15.	OVERLAND RELEASE.....	73
9-16.	PIPE STUBS.....	74

9-17.	HEADWALLS AND RACKS.....	74
9-18.	DRAINAGE PUMPS	75
9-19.	DETENTION SYSTEMS.....	75
9-20.	OPEN CHANNELS.....	76
9-21.	OUTFALL PLANS	77
9-22.	SITE REQUIREMENTS.....	78
9-23.	CROSS CULVERT CRITERIA	79
9-24.	DRAINAGE IN RURAL AREAS	80
9-25.	STORM DRAIN SYSTEMS IN PRIVATE STREETS	80
 SECTION 10 GRADING		
10-1.	GENERAL REQUIRMENTS	87
10-2.	PLAN SHEET DETAILS.....	87
10-3.	ROLLING TERRAIN GRADING	88
10-4.	BOUNDARY GRADING	88
10-5.	INTERIOR GRADING	88
10-6.	RETAINING WALLS	89
10-7.	GRADING AT TREES	90
10-8.	CERTIFYING PAD ELEVATIONS	90
10-9.	MAINTENANCE OF ACCESS TO UTILITY FACILITIES	90
 SECTION 11 STORMWATER QUALITY PROTECTION		
11-1.	DEFINITIONS / ACRONYMS.....	91
11-2.	STORMWATER POLLUTION PREVENTION PLAN (SWPPP)	91
11-3.	EROSION AND SEDIMENT CONTROL PLAN (ESCP)	93
11-4.	CONSTRUCTION BEST MANAGEMENT PRACTICES (BMPS).....	94
11-5.	SCHEDULE	96
11-6.	MONITORING AND MAINTENANCE	96
	PART II – NEW DEVELOPMENT CONTROL MEASURES.....	97
 SECTION 12 SURVEY MONUMENTS		
12-1	SURVEY MONUMENT REQUIREMENTS.....	98
 SECTION 13 TRAFFIC SIGNAL DESIGN		
13-1.	DESIGN STANDARDS	100
13-2.	GENERAL PLAN REQUIREMENTS	100
13-3.	PULL BOXES	100
13-4.	SIGNAL INTERCONNECT	100
13-5.	LIGHTING TYPE CONSISTENCY	100

SECTION 1

PURPOSE AND DEFINITIONS

1-1. PURPOSE

The purpose of this Manual is to serve as a guide through the Development permitting process and establish minimums to be used in the design and drawing of plans for public and private works. Design standards may be augmented by City Council action, such as a Specific Plan, and/or by written approval of the Director. This manual is designed to explain the permitting process required to obtain Engineering approval, and ultimate acceptance of projects, for each of the following phases: Planning, Improvement Plans, and Mapping.

This Manual provides standards to be applied to public improvements and private works that will be dedicated to the public and accepted by the City for maintenance and/or operation, as well as improvements to be installed within existing rights-of-way and easements. This is necessary to provide for coordinated development of required facilities to be used by, and for the protection of, the public.

This Manual shall serve to regulate and guide the design and preparation of plans for: construction of streets, highways, alleys, drainage, sanitary sewer, street lighting, water supply facilities and related public improvements, and set guidelines for all private works which involve drainage, grading, erosion control, trees and related improvements.

1-2. RELATIONSHIP TO OTHER CITY-ADOPTED PLANS AND POLICIES

This Manual provides procedures and design standards that generally apply to projects and improvements Citywide in conformance with the Elk Grove Municipal Code (EGMC). Should any conflicts or inconsistencies occur between this manual and the EGMC, the EGMC shall govern. In some cases, such as in areas covered by a specific plan, certain elements of design may be governed by other City-adopted Plans and Policies. Applicants and Consulting Engineers shall refer to the appropriate policy document(s) when preparing engineered plans for review by the City. A list of existing plans and policies is included but not limited to the following:

- Specific & Community Plans – Southeast Policy Area, Laguna Ridge, East Elk Grove, and East Franklin
- Special Planning Areas – as kept on file with Development Services Department
- City of Elk Grove Design Guidelines
- Bicycle, Pedestrian, and Trails Master Plan
- Rural Road Improvement Policy and Standards
- Citywide Storm Drainage Master Plan
- Project-specific Master Infrastructure Plans
- Traffic Impact Analysis Guidelines

1-3. OTHER AGENCY COORDINATION

While this Manual covers certain aspects, such as layout and location of all facilities within the public right-of-way, reference shall be made to the appropriate agency's standards when their facilities are involved and/or the plans include work within an agency's jurisdiction.

Specifically, the design of sanitary sewer facilities and water supply systems shall conform to the requirements set forth in the various local sewer and water agency's standards specifications, improvement standards and standard drawings "latest edition", which have jurisdiction within the City limits.

Other agencies typically involved in reviewing improvements within the City's jurisdiction include, but are not limited to:

- CCSD Parks & Recreation
- CCSD Fire Department
- Elk Grove Water District
- Sacramento County Water Agency
- Sacramento Area Sewer District

1-4. OMISSIONS

Any items or situations not included in this Manual shall be designed in accordance with accepted engineering practice, the City of Elk Grove Municipal Code, City of Elk Grove Standard Construction Specifications, , and the latest editions of the State of California "Highway Design Manual", State Standard Plans and Specifications", "CaMUTCD", and as required by the Director herein defined.

1-5. DEFINITIONS

When the following terms or titles are used in these standards or in any document or instrument where these standards govern, the intent and meaning shall be as herein defined:

- A. Applicant – Shall mean a person, resident, landowner, developer, firm, agency, corporation, partnership, association or their representative, engaged in the land subdivision or development process
- B. CaMUTCD – Shall mean California Manual on Uniform Traffic Control Devices
- C. CCSD – Shall mean Cosumnes Community Services District
- D. City – Shall mean the City of Elk Grove, a municipal corporation. In some instances throughout the Manual, "City" may mean the Public Works Director, Development Services Director and/or their designee(s).
- E. City Code – Shall mean the Elk Grove Municipal Code.

- F. City Council – Shall mean City Council of the City of Elk Grove.
- G. City Engineer – Shall mean the designated Engineer representing the City.
- H. Consulting Engineer – Shall mean any person or persons, firm, partnerships or corporation legally authorized to practice civil, mechanical or electrical engineering in the State of California who prepares or submits improvement plans and specifications to Public Works or Development Services.
- I. Development Services - Shall mean the Development Services Department of the City Elk Grove
- J. Engineering Division – The Engineering Division within the City that is responsible for the review of Public Improvements related to private land development activities.
- K. Director - Shall mean the Director of Public Works of the City of Elk Grove or his/her designee.
- L. Development – Shall mean the act, process, or result of any land grading, utility installation, street or building construction on property.
- M. Improvement Standards – Shall mean all design standards, criteria, and requirements as outlined in this Manual, including all revisions and updates thereto.
- N. Improvement Plan - An engineered plan, prepared by a licensed civil engineer in the State of California, showing the design, sanitary sewers, storm drain, water systems, grading and earthwork, roadways, and all other appurtenant structures, facilities and construction, including engineering calculations, comprising improvements required for a development project or work within the public right-of-way.
- O. Laboratory – Shall mean any testing agency or testing firm which has been approved by the City of Elk Grove Public Works Department.
- P. Manual – Shall mean this Manual, including all revisions and updates thereto.
- Q. Mitigation Monitoring and Reporting Program (MMRP) – An environmental mitigation program administered by the Planning Division of the Development Services in accordance with City Code.
- R. Public Works – Shall mean the Public Works Department of the City of Elk Grove.
- S. Specifications – Shall mean the latest standard construction specifications adopted by the City Council governing the construction of roads, streets, sanitary sewers, storm drainage, concrete structures, water supply, traffic signals, street lighting and other facilities within the City of Elk Grove to be accepted by the City for maintenance and/or operation. Specifications also govern grading, erosion control, drainage, and landscaping.
- T. Standard Drawings – Shall mean the standard drawings adopted by the City.

SECTION 2

GENERAL PROCEDURES AND REQUIREMENTS

2-1. ENGINEER REQUIRED

All plans and specifications for improvements which are to be accepted for maintenance by the City and private on-site drainage and grading shall be prepared by a Consulting Engineer of the appropriate branch of engineering covering the work submitted.

2-2. PLANS REQUIRED

Complete plans for all proposed streets, bikeways, grading, erosion control, drainage facilities, sanitary sewer, street lighting, traffic signals, water distribution systems, including any necessary dedications and easements, shall be submitted to the City for review and approval. Copies of rights-of-entry obtained from adjacent properties, if required, shall be provided to the City prior to approval of plans.

2-3. WORK IN CITY RIGHTS-OF-WAY, EASEMENTS AND WATERWAYS

The following shall govern work performed within City rights-of-way, easements, and waterways:

- A. Possession of a complete set of City-approved improvement plans shall allow a contractor, duly licensed by the State of California, to perform work specified on the plans in City right-of-ways, easements and waterways. The contractor shall be bonded as required and as specified in the City Code.
- B. Possession of a valid encroachment permit issued in accordance with City Code and the City encroachment permit policy, as adopted by the City Council will allow a contractor, duly licensed by the State of California, to perform work specified in the permit in City rights-of-way.

2-4. PRELIMINARY PLAN SUBMITTAL REQUIREMENTS (ENTITLEMENTS)

Projects requiring planning and/or zoning-related permits may require submission of preliminary engineered plans, drawings, or studies in accordance with the current version of the City's Planning Submittal Requirements. Please refer to the City's website (www.elkgrovecity.org) for the current version of the Planning Submittal Requirements.

Specific requirements vary based on planning permit or entitlement type and may include, but not be limited to, the following:

- Site Plan
- Tentative Map
- Preliminary Grading Plan
- Stormwater Quality Conceptual Plan
- Preliminary Drainage Study
- Traffic Impact Analysis

Plans and studies required as part of a development application shall conform to these Improvement Standards and as required by the City.

2-5. IMPROVEMENT PLAN SUBMITTAL REQUIREMENTS

Development Services shall act as the lead department in the submittal process for improvement plans. The submittal package shall be submitted as a whole directly to Development Services, per the requirements of the appropriate Submittal Requirements Form. Please refer to the City of Elk Grove web site (www.elkgrovecity.org) for current Submittal Requirements and Forms. These apply to all types of submittals including civil improvement plans, landscape plans, and grading plans for private and public improvements. Copies of the current Application Forms are also available directly from Development Services.

Once the submittal has been deemed complete by the City, the packets will be distributed by Development Services to the appropriate Departments/Divisions, including but not limited to:

- Building /Addressing
- Landscape Architectural
- Mapping
- Planning Environmental/Planner of the Day (POD)
- Construction Management
- Operations & Maintenance
- Public Works – Traffic Division
- Public Works – Drainage Division

Each department will review the improvement plans and forward comments to the Engineering Division of Development Services. The Applicant shall respond directly to Engineering Division of Development Services to address each department's comments. The City will not approve the plans until all other departments have accepted the plans along with any other agencies requiring approval.

Discretionary projects which have obtained approval of their entitlement(s) by the appropriate approval body may submit improvement plans for review. At the discretion of the City, projects pending approval of their entitlements may submit plans "at-risk" for concurrent review. Unless otherwise approved by the City, "at-risk" plans may only be submitted after Conditions of Approval have been made available by the Planning Division of Development Services and an "at-risk" letter has been provided by the Applicant to the satisfaction of the City.

Should there be required alterations or revisions to the plans as submitted, Development Services will return one copy with the corrections marked or indicated thereon. If the plans submitted are not prepared in accordance with these Improvement Standards or are not in keeping with the standards of the profession, Development Services may return them unmarked and unapproved. Separate submittal of plans to other agencies may be required for approval.

2-6. MAPPING SUBMITTAL REQUIREMENTS

Submittal of all mapping applications shall be made to the City in accordance with the respective Submittal Requirements Form. Please refer to the City of Elk Grove web site (www.elkgrovecity.org) for current Submittal Requirements Forms. This includes, but is not limited to, the following types of applications:

- Final Maps
- Easements
- Right-of-way Vacation / Abandonment
- Lot Mergers
- Certificate of Compliance and Correction
- Boundary Line Adjustments

2-7. RESUBMITTAL REQUIREMENTS

Development Services will indicate the number of plan sets to be resubmitted. The Applicant shall notify Development Services if plans being resubmitted contain revisions or alterations other than those required on previously corrected plans. Revision notations shall not be shown on the plans until after the City has formally approved the plans. Landscape plans, if applicable, are required with or before the second submittal.

2-8. PLAN REVIEW AND INSPECTION FEE

When a submittal package is submitted to the City for review, an initial plan review and inspection fee/deposit is required to initiate City plan review. Fees shall be based on the type of application in accordance with the City's current established fee schedule. For the most current fee schedule, please visit the City of Elk Grove website at: www.elkgrovecity.org.

For Fixed Fee type projects, payment 50% of plan check and inspection fees are required at time of initial submittal. Fixed Fees are based on an Engineering cost estimate of the proposed improvements. The cost estimate shall be submitted to the City for review prior to the Applicant providing their submittal package for review. The remaining balance, which will be based on the signed, final construction contract bid price, shall be due upon plan approval, unless authorized by the City to defer payment prior to the City scheduling a pre-construction meeting. For deposit-based projects, the Applicant shall be responsible for payment of actual costs incurred by the City in providing plan check and inspection services. All deposits will be held against actual time and materials billing for the project. Should the development not be carried to completion, any portion of the required deposit over and above the accumulated costs expended by the City on the development will be refunded to the Applicant. If at any point the deposit falls below the thresholds established in the City's Deposit Replenishment Policy, all work will be stopped until an additional deposit is made in accordance with this policy.

Failure of an Applicant to complete a project does not relieve the Applicant of paying all costs incurred by the City. Applicant is obligated to pay for all outstanding charges.

The City shall be notified of any change of billing address. The Consulting Engineer shall notify the City immediately upon change of owner and/or Applicant.

2-9. PLAN APPROVAL

No plans will be approved nor construction authorized until the City signifies approval by signing the cover sheet of the full set of plans and all other pre-construction requirements have been satisfied, including but not limited to holding a pre-construction conference, payment of any outstanding fees, and providing required advanced notice to City inspection staff. Revisions, corrections or additions shall be resubmitted to the Development Services for approval. At such time as the Consulting Engineer preparing the plans has made the necessary revisions and signed and stamped the original plans, and fees have been paid, as provided under the provisions of the City Code and amendments thereto, a designated representative of the City will sign the plans in the space provided. The plan approval is valid for a period of twelve (12) months. Should construction not commence within the 12-month period, the plans shall be resubmitted for re-approval. The City shall order any Contractor to cease work on any project if said Contractor does not have properly approved plans in his possession.

2-10. APPROVED PLANS REQUIRED

The Consulting Engineer shall deliver the requested number of sets of prints from the approved original plans to the City, which is typically six (6) full size sets and four (4) half size sets as well as one electronic file in PDF format. Additional copies of improvement plans may be required by the Director in certain circumstances and these shall be furnished to the City without cost.

Copies of the final utility letters required by this Section shall be included with the approved plans delivered to the City.

2-11. IMPROVEMENT PLAN REVISIONS DURING CONSTRUCTION

Should changes become necessary during construction, the Consulting Engineer shall first obtain the consent of the City and shall then resubmit the title sheet and the plan sheets affected for approval. The changes on the plans shall be made in the following manner:

- A. The original proposal shall not be eradicated from the plans but shall be lined out.
- B. For changes affecting 25% or more of detail on sheet (plan or profile), the original proposal shall be omitted.
- C. In the event that eradicating the original proposal is necessary to maintain clarity of the plans, approval must first be obtained from the City.
- D. The changes shall be clearly shown on the plans with the changes and approval noted on the revision signature block.
- E. After three (3) or more revisions have been approved, the City may require complete reproduction of the plan set.

- F. The changes shall be identified by the revision number in a triangle delineated on the plans adjacent to the change and on the revision signature block.

Minor changes that do not affect the basic design or contract may be made, with the authorization of the City, upon completion of the work before final acceptance of the completed improvements.

Certification by the Consulting Engineer of the finished pad elevations of subdivision lots shall be required prior to final acceptance of the subdivision improvements. Certification shall be in accordance with Section 10-8 of this Manual.

2-12. RECORD DRAWINGS

SPECIAL NOTE: Water-line connections must be made prior to final paving to prevent utility cuts through the final lift of paving. Sacramento County may not allow final water-line connections until they have received the underground as built information. To insure that water-line connections can be made prior to final paving, Developers must submit Record Drawings of underground work (particularly water utilities) to Sacramento County.

The Applicant shall maintain an accurate record of all approved deviations from the plans before and during construction. Upon completion of work, one set of red-lined plans reflecting all such deviations shall be submitted to the City for review. Following the City's review and approval, the redlined sets shall be converted to Record Drawings. The cover sheet shall include the following statement signed by the engineer in responsible charge: "These record drawings reflect the original City approved design and City approved revisions thereto, along with all field modifications reported by the contractor". Each sheet shall be marked "RECORD DRAWING" and shall contain the Consulting Engineer's original registration stamp and signature.

The following shall be submitted to the City in consideration of improvement acceptance:

- A. Grid coordinate data for plans, maps, data, and exhibits shall be submitted in California State Plane, Zone II, North American Horizontal Datum of 1983 (NAD 83), and National Geodetic Vertical Datum of 1929 (NGVD 29) grid projection in US survey feet. CAD files shall incorporate these grid data.
- B. Electronic plan submittal acceptable to the City containing the following:
- C. Record Drawings of all improvements in a PDF File. The format shall be Adobe Acrobat, most recent or second most recent published software version. The resolution of improvement plan images shall be at least 400 dpi.
- D. A separate copy of the Record Drawing sheets for streetlight and traffic signal improvements in a PDF file. The file shall contain all sheets pertaining to streetlight improvements, including streetlight locations and circuit diagrams. The format shall be Adobe Acrobat, most recent or second most recent published software version. The resolution of improvement plan images shall be at least 400 dpi.

- E. The most up-to-date Computer-Aided Drafting file reflecting the original approved design and any approved revisions that were made electronically. The format shall be AUTOCAD, most recent or second most recent published software version.

2-13. DEVIATION FROM STANDARDS

All requests for approval of exceptions from the design requirements contained within these Improvement Standards shall be submitted in writing to Development Services. Approval for exceptions shall be sought as early as possible in the project development process, particularly where the project concept and/or cost estimate depend on the proposed design exceptions.

Requests for design exceptions shall include the following:

- A. A statement of the specific standard for which a design exception is requested.
- B. A thorough but brief description of the reason for the request for the design exception.
- C. A description of any non-standard safety enhancements to be provided such as median barriers, guardrail updates, etc.
- D. An estimate of the additional cost required to conform to the required standard.
- E. The request must be sealed and signed by a California Registered Civil Engineer.

The approval of all deviations from these standards shall be made by the City Engineer.

2-14. CONFLICTS, ERRORS AND OMISSIONS

Acceptance of improvement plans by the City is based on the assumption that the information contained on the plans and supporting documents is correct and does not subrogate the Consulting Engineer's responsibility for this project. Any and all errors and omissions related to the design are the responsibility of the Consulting Engineer.

Excepted from approval are any features of the plans that are contrary to, in conflict with, or do not conform to any California State Law, City Code or Resolution, conditions of approval, or generally accepted good engineering practice in keeping with the standards of the professions, even though such errors, omissions or conflicts may have been overlooked in the City's review of the plans.

2-15. CHANGE IN CONSULTING ENGINEER

If the Applicant elects to have a registered civil engineer or licensed land surveyor other than the engineer who prepared the plans provide the construction staking, he/she shall provide to the City in writing, the name of the individual or firm one week prior to the staking of the project for construction. The Applicant shall be responsible for:

- verifying all construction,
- the preparation of revised plans for construction changes, and
- the preparation of record drawings upon completion of the construction.

In the Applicant's notification of a change in the firm providing construction staking, he/she shall acknowledge that he/she accepts responsibility for design changes and record drawing information as noted above.

2-16. BORING AND JACKING SAFETY REQUIREMENTS

Any boring or jacking operation involving an opening greater than 30 inches in diameter is subject to the State of California Division of Industrial Safety's tunnel safety requirements. If the design plans require any boring and jacking, the Consulting Engineer shall submit to the State Division of Industrial Safety plans and specifications applicable to the tunnel operation, with a letter requesting tunnel classification, prior to bidding the project. This procedure is also recommended to avoid project delay if there is the possibility of any personnel entering the tunnel, regardless of diameter and length. The letter shall identify the agency responsible for the project and the agency's mailing address. The plans shall identify underground utilities and tanks or areas for storing fuel and toxic gases in the vicinity of the tunnel site and a description of the historical land use in the area. The request for classification shall be submitted allowing ample time for the Division of Industrial Safety's review in order that any special requirements can be included in the project plans and specifications. The Consulting Engineer shall also attend the required pre-construction meeting.

2-17. UTILITIES

- A. All new sidewalk construction adjacent to roadways shown on Figure 1 – Fiber Backbone Network (below) shall install a minimum of 2ea 2-inch diameter and 1ea 4-inch diameter plastic ducts for future use by the City. Each conduit shall include a pull-wire and have a Type 6 Pull Box installed at a maximum spacing of 500 feet.
- B. All known existing utilities are to be shown on the plans. In addition, the Consulting Engineer shall submit prints of the preliminary and approved plans to the utility companies involved. This is necessary for the utilities to properly plan their relocation projects and needed additional facilities. Copies of the transmittal letters to the utility companies shall be provided to the City. In addition, the following note shall appear on the first page of the plans:

"No pavement work will occur within existing public right-of-way prior to completion of any necessary utility pole relocation within the public right-of-way."

- C. Existing and new dry utilities (low and high voltage electrical, gas, telephone, cable, fiber optics and similar) fronting new development shall be placed underground except for very high voltage (69 kV or greater). Relocated power poles for very high voltage, which cannot feasibly be placed underground, shall be placed behind the back of the sidewalk. All lower voltage lines shall be removed from these poles and placed underground. Once placed underground in an area, no new overhead lines shall be installed, even if power poles exist.

- D. Utility manholes and boxes for dry utilities shall not be placed in sidewalks or curb ramps. All dry utility box covers shall be appropriately labeled “Telephone”, “Streetlight”, “Cable”, “Electric”, “Gas”, etc. If the Consulting Engineer approves the installation of a dry utility box in a sidewalk due to extraordinary circumstances, as determined by the City, such box and lid shall be traffic-rated and shall be placed flush with the sidewalk grade.
- E. Hydraulic jetting of utility trenches is not allowed within the City of Elk Grove.
- F. Tree preservation and protection shall be consistent with the City Code.

Figure 1 – Fiber Backbone Network

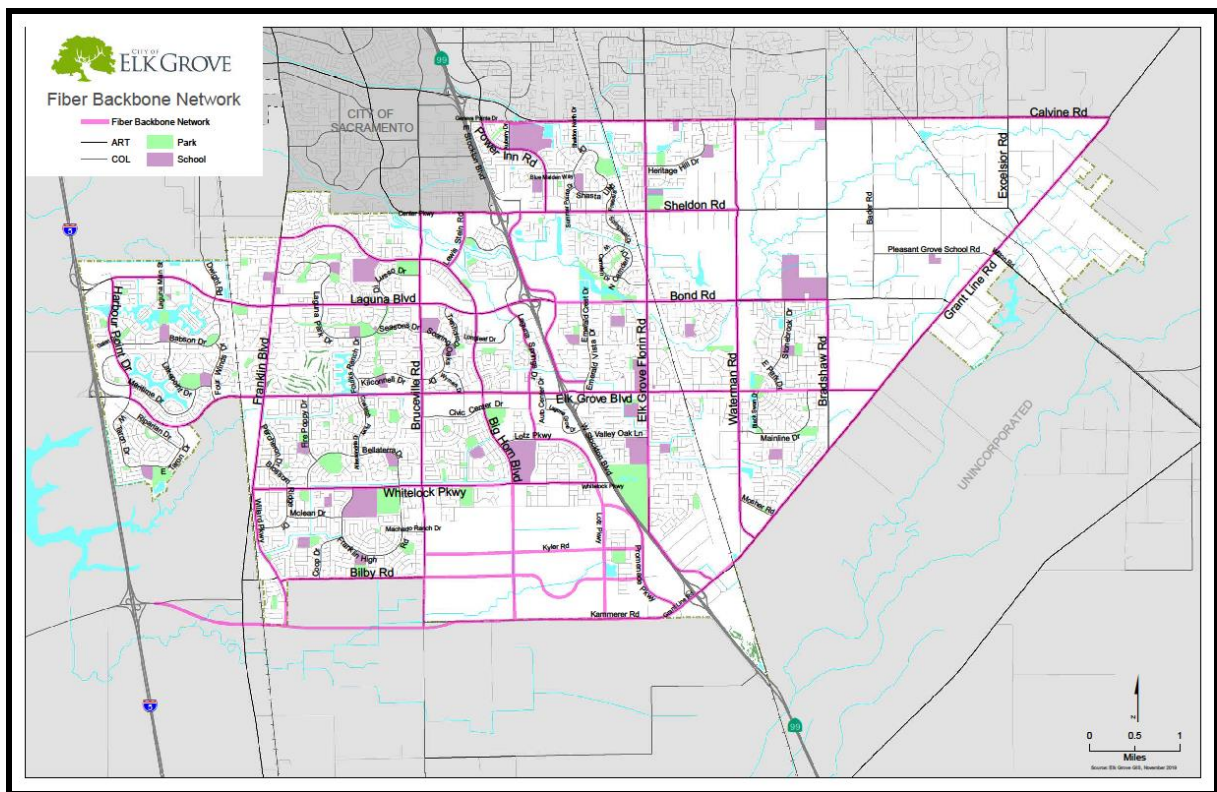

2-18. PARTIAL PLANS

Where the improvement plans submitted cover only a portion of ultimate development, the plans submitted shall be accompanied by the approved tentative plan or study plan of the ultimate development.

2-19. OTHER AGENCY NOTIFICATIONS

Prior to City approval, the Consulting Engineer is responsible for obtaining the approval and necessary permits of other governmental or municipal agencies when their facilities are involved and/or the plans include work within an agency’s jurisdiction.

2-20. INSPECTION REQUIREMENTS

Any improvement which will ultimately be maintained by the City will be inspected during construction by the City. Each phase of construction will be inspected and approved prior to proceeding to subsequent phases.

The City will inspect all grading and drainage during construction, including private stormwater quality improvements.

Any improvement constructed without inspection as provided above, or constructed contrary to the order or instruction of the City, shall be deemed as not complying with the Standard Construction Specifications and this Manual and may not be accepted by the City of Elk Grove for maintenance purposes.

The Applicant shall notify the City when the Contractor first calls for grades and staking and shall provide the City with a copy of all cut sheets.

Within ten (10) days after receiving the request for final inspection, the City shall inspect the work. The Contractor, Consulting Engineer, and/or Applicant will be notified in writing as to any particular defects or deficiencies to be remedied. The Contractor shall proceed to correct any such defects or deficiencies at the earliest possible date. At such time as the work has been completed, a second inspection shall be made by the City to determine if the previously mentioned defects have been repaired, altered, and completed in accordance with the plans. At such time as the City approves the work and accepts the work, the Contractor, Consulting Engineer and/or Applicant will be notified in writing as to the date of final approval and acceptance.

For assessment districts and projects where the City participates in the costs thereof, quantities shall be measured in the presence of the City, Consulting Engineer, and Contractor, and witnessed accordingly.

2-21. COMMERCIAL / PRIVATE PROPERTY INSPECTION REQUIREMENTS

- A. City staff will perform inspections on all improvements within City right-of-way or other public easements, including all stormwater quality improvements, whether public or private.
- B. The City and/or appropriate utility service providers will inspect sewer, water, and drainage connections within the public right-of-way and to the point of service for the respective utilities.

2-22. SPECIAL NOTICES AND PERMITS

The Consulting Engineer shall be responsible for advising the Contractor as follows:

- A. Contractors shall be in receipt of official City approved plans and shall participate in a pre-construction conference with City staff prior to construction.
- B. Contractor shall notify all utility companies involved in the development prior to beginning of work.

- C. Contractor shall notify Underground Service Alert two working days in advance before an excavation.
- D. Contractor shall be responsible for the protection of all existing monuments and/or other survey monuments and shall notify the City of any damaged or removed City, County, State or Bureau monuments.
- E. Contractor shall be responsible for conducting his operation entirely outside of any floodplain boundaries, unless otherwise approved. 100-year floodplain boundaries shall be clearly delineated in the field by the Contractor or Applicant prior to construction.
- F. Contractor shall be responsible for conducting his operation entirely outside of any no grading area. These areas shall be clearly delineated in the field by the Contractor or Applicant prior to construction.
- G. Where work is being performed in an off-site easement, the Contractor shall notify the property owner within two (2) working days prior to commencing work.
- H. Contractor shall not dispose of chlorinated water or any other non-stormwater discharge into the City drainage system unless an exception is granted in accordance with Chapter 15.12 of City Code.

SECTION 3

IMPROVEMENT PLAN REQUIREMENTS

3-1 ELECTRONIC SUBMITTALS

At the discretion of the City, plans prepared on a computer may be submitted in electronic format for review. Only plans prepared using AutoCAD (acceptable versions as determined by the City) will be accepted. Plans may be submitted on an electronic storage device or via e-mail, as required by the City. Electronic plan submittals shall include all that is required in this Manual.

3-2 PAPER SIZE AND SCALE

All improvement plans shall be submitted on 24" X 36" paper unless otherwise accepted by the Director. Only common engineering scales shall be used.

3-3 DRAFTING STANDARD

All line work must be clear, sharp and of appropriate weight. Letters and numerals must be 0.1 inch minimum height, well formed, and sharp. Line work shall not intersect numerals showing profile elevations. Sharp, solid arrowheads shall terminate dimension lines.

3-4 TITLE SHEET

When possible, all improvement plans shall have the following information as a minimum on the cover sheet:

- The entire subdivision or parcel and project
- Assessment district limits (if applicable)
- City limits (if applicable)
- Street names (and widths when practical)
- Adjacent subdivision and/or property information, including names, lot lines and lot numbers and/or Assessor's Parcel Number(s)
- Property lines
- Public easements
- Location map
- Scale of drawings, including scale bar
- Index of sheets
- Legend of symbols
- Signature and revision blocks conforming to the Standard Drawing
- Benchmark information
- MMRP control number
- WDID #

3-5 TITLE BLOCK

Each sheet within the set of drawings shall have an approved title block showing the following.

- Sheet title
- Sheet number
- Date
- Scale
- Consulting Engineer's name, signature and seal. (Signature may be placed across the seal.)
- Project title

The title block shall be either across the bottom or along the right edge of each plan sheet.

3-6 DRAINAGE, SEWER, WATER, SIGNING AND STRIPING AND GRADING LAYOUT

On all subdivision plans, a separate plan is required for each of the following:

- Water
- Signing and Striping, including any required traffic calming features
- Streetlights (unless it is appropriate to include with the signs and striping)
- Grading and erosion control

In addition, the storm drainage, sanitary sewer and water systems shall be shown on the plan and profile sheets. On all other plans, a composite plan layout of each system will be acceptable.

All plans showing the domestic water systems shall include signature blocks and be approved by the responsible water and fire departments. The signature block shall conform to Standard Drawing D-1 and shall be on the cover sheet of the plan set.

3-7 PLAN DETAILS

In addition to the other requirements set forth in this Manual, the following details shall be shown on the plans submitted for approval. This does not in any way exempt the Consulting Engineer preparing plans from the responsibility of preparing neat, accurate and comprehensive plans in keeping with the standards of the profession.

- A. Record Information - All existing and proposed record information shall be shown, including:
- Right-of-way lines
 - Boundaries of lots fronting on the street
 - Easements
 - Both on-site and off-site right-of-way and easement lines shall be properly dimensioned
 - Existing street addresses, where applicable

- All Survey monuments including boundary and all centerline monuments and ties.
- B. **Existing Facilities** - All pertinent existing facilities shall be shown, including but not limited to:
- Pavement delineation and traffic signage
 - Medians
 - Driveways (on both sides of the street along the project frontage)
 - Curbs, specifying type (rolled curbs or vertical curbs)
 - Sidewalks
 - Sidewalk ramps
 - Pavement shoulders
 - Location and size of all underground utilities, including but not limited to water, storm drainage, and sanitary sewer lines
 - Limits of 100-year and 200-year floodplains, where applicable
 - Structures
 - Trees (6" and larger) and other foliage
 - Traffic signals, cabinets, pull boxes and traffic detector loops with detector hand holes
 - Street lights, cabinets, pull boxes, and underground electrical conduits
 - Drainage ditches
 - Utility poles and transformers
 - Fire hydrants
 - Retaining walls
 - Contractor's Surveyor or Engineer's Surveyor shall be responsible for maintaining all survey monuments and shall file corner records and/or a record of survey pursuant to Section 8871 of the Professional Land Surveys Act.
 - Any other features which may affect the design requirements for the project area
- C. **Contours and Elevations** - Existing contours and supporting spot elevations shall be shown on all plans that extend one hundred feet (100') minimum beyond limits of work. See Section 10 for boundary grading requirements.
- D. **Profiles** - The plans shall show the existing profile of all roadway centerline, edges of pavement, gutter flow lines, 100-year hydraulic grade lines (HGL) at critical locations, drainage ditches, existing water, storm drainage and sanitary sewer systems. Designs of proposed public improvements shall include profiles showing centerline elevations at 50-foot intervals and rates of grades, vertical curves and other vertical alignment data as deemed necessary by the City. Designs for vertical curves shall show elevations at 25-foot intervals. Where it exists, City stationing

shall be used for profiles of public streets. The Consulting Engineer shall contact Development Services for such stationing. When clearance between utilities is less than two feet (2') the clearance shall be noted by dimension in the profile.

The plans shall show the existing ground profile for a minimum distance of 200 feet beyond temporary street endings to ensure proper vertical alignment within the proposed improvement limits. The 200-foot minimum requirement may be increased as requested by the City.

- E. **Stationing and Orientation** - The stationing on plan and profile shall read from left to right. Stationing shall increase from south to north or from west to east, except for cul-de-sacs, where stationing shall proceed from the intersection. Plans shall be so arranged that the North arrow points toward the top or upper 180 degrees, insofar as practical.
- F. **Bench Marks** - Location, description, and elevation of benchmarks and datum shall be clearly delineated on the plans. The datum shall be 1929 North American Datum (U.S.G.S. or U.S.C. & G.S.) unless otherwise approved by the City. Consulting Engineers shall contact Development Services for location and elevation of the official benchmark nearest their project.
- G. **California Coordinates System** - The City may require that proposed improvements be tied into the California Coordinates System if monument coordinate points are available within a reasonable distance (200 feet or less) of said improvement as determined by the City.
- H. **Cross Sections** - Cross sections shall be included in the plans where determined necessary by the City. Sections shall include all pertinent structural and topographical features. Section calls shall be identified by a number and letter and the sheet on which the section appears.
- I. **Special Notes** - Special Notes shall be clearly indicated. Notes shall contain a statement regarding obtaining encroachment permits from other agencies when applicable.
- J. **Detail Sheets** - Detail sheets, if necessary, shall delineate special details, structural designs, etc., for which no City standard drawing exists, and when space is not available on the plan and profile sheets.
- K. Plan views of the structure for which details of design are to be provided shall be shown on the detail sheets depicting the location of said structure in relation to street centerlines, stations, bearings, skews, grades, etc. Structural details shall be delineated at a scale that will clearly define all facets of the design.
- L. **Other Plans** - Other plans that shall be incorporated in the improvement plans include, but are not limited to, landscaping and irrigation; retaining and decorative soundwalls; and traffic signals. The layout of meandering sidewalks, soundwalls, pedestrian pass-throughs, etc., shall be shown on the improvement plans along with any grading associated with these improvements in addition to being shown on the landscaping plans.

3-8 REQUIRED NOTES

A list of City required notes shall be included on all improvement plans submitted to the City for approval. A list of current notes is available on the City's website (www.elkgrovecity.org) and may also be obtained from Development Services.

3-9 STANDARD DRAWINGS

Consulting Engineers shall not include the standard drawings included herein on improvement plans, but shall refer to the drawing by number. If a design exception to a standard drawing is intended, the drawing shall be shown with the exception noted. The design exception shall be processed in accordance with this Manual and City-adopted policies.

SECTION 4

STREETS

4-1. DEVELOPER'S PAVEMENT, SIGNAL, AND STREET LIGHT RESPONSIBILITY

- A. Construction of street improvements shall conform to the centerline established by the City.
- B. Where the existing pavement section does not generally meet the current structural section standard and/or the centerline grade and alignment are not satisfactory to the City, the Applicant shall be responsible for the pavement section to the centerline on all streets within, adjacent, and contiguous to the Applicant's project.

The Applicant shall overlay any areas beyond the centerline where the design centerline grade deviates from the existing. The Applicant shall also be responsible for overlaying any low areas where the new pavement meets the existing pavement to maintain a uniform cross slope.

- C. When making a connection to an existing street end, the Applicant shall be responsible for removing and reconstructing the existing roadway to make a satisfactory connection as required by the City.

When making connections to existing pavement, the Applicant shall be responsible for a 1-foot minimum sawcut of the existing pavement along with an additional 1-foot by 1½" deep grinding and paving. Refer to Standard drawing ST-38 for pavement restoration.

- D. The Applicant shall be responsible for all of the structural section and pavement on all streets within, adjacent, and contiguous to the project, including frontage roads, as required by the City. If the street is to be paved under a future City contract, the Director may require a cash deposit for the roadway and related work in lieu of actual construction and the City will include the work in the City contract.
- E. All temporary approaches to existing roadways required as a result of the development shall be at the Developer's expense. The temporary approaches shall be paved with a structural section to be determined individually for each situation.
- F. The Developer shall be responsible for relocating existing traffic signals and street lights, and installing new traffic signals and street lights as necessary for new street and driveway locations. The Developer shall also be responsible for relocating existing traffic signals and street lights as necessary for the installation of new curbs, bus stops and turn-outs, and sidewalks at locations where there are no such facilities existing.
- G. The City may elect to prepare the traffic signal relocation construction plans to be given to the Developer if requested in writing. In lieu of actual plan preparation, the City will provide all pertinent design information to be included by the Developer on their plans within 30 days after being requested in writing and the Developer's

engineer provides an acceptable base plan. The City's design costs shall be reimbursed by the Developer.

- H. For intersections with new traffic signal construction that is located within one half of a mile of an intersection with an existing traffic signal, the work shall include the installation of traffic signal interconnect conduits and conductors to connect the new traffic signal to the nearest existing traffic signal. Should interconnect conduits exist through an intersection where a new signal is to be constructed, the work shall include the connection of the new traffic signal into the existing interconnect system. Such work may include the installation of new interconnect cable from the traffic signal to the nearest existing traffic signal.

The design of the traffic signal interconnect facilities shall be subject to the review and approval by the City of Elk Grove Public Works Department

- I. The Applicant shall be responsible for constructing or modifying curbed median islands where required by these standards, or when required for traffic control as a result of the development, as determined by the Director. If the street is to be paved under a future City contract, the Director may require a cash deposit for the roadway and related work in lieu of actual construction and the City will include the work in the City contract.
- J. The Applicant shall be responsible for bus stops, bus turnouts, and intersection widening as shown on Standard Drawings and in accordance with these Standards.
- K. The Applicant shall be responsible for all drainage facilities (bridges, pipes, culverts, and appurtenances) crossing new streets within, adjacent, and contiguous to the project.
- L. The Applicant shall be responsible for all associated modifications to allow for access for the disabled, including but not limited to: guide-strips, sidewalk ramps, striping, etc.

4-2. CITY COST PARTICIPATION

Costs associated with the design and construction of eligible facilities included in various fee programs, Community Facilities Districts, Assessment Districts, or other funding programs may be reimbursable to the Applicant as set forth in the applicable funding program(s). In order to ensure eligibility for such reimbursements, the Applicant must comply with the current version of the City's Reimbursement Policies and Procedures for Privately Constructed Public Facilities, which is available on the City's website (www.elkgrovecity.org).

Applicants wishing to seek reimbursement from the City shall provide a written request to the City for cost participation if the proposed work is beyond the Applicant's responsibility. This application shall show the items of work, the estimated quantities, reimbursable costs, and justification for the request. Upon review of the Applicant's request, the City will notify the Applicant as to the acceptance and the extent of cost participation. Should an agreement be reached between the Applicant and the City on the methods and level of participation, the parties must enter into, and execute, a formal "cost

sharing/reimbursement” agreement specifying the terms of the agreement prior to starting such work.

Costs associated with design and construction of eligible facilities included in fee programs, Community Facilities Districts, Assessment Districts, or other funding programs may be reimbursable to the Applicant as set forth in the applicable funding program(s). In order to ensure eligibility for such reimbursements, the Applicant must comply with the current version of the City’s Reimbursement Policies and Procedures for Privately Constructed Public Facilities, which is available on the City’s website (www.elkgrovecity.org).

Any portion of work shown on the Consulting Engineer’s plans, for which the City has agreed to cooperate, shall not be segregated by note or legend, but shall be identified as separate items in the Construction Contract between the Applicant and their Contractor. The City will reimburse the Applicant for these reimbursable items after the work has been accepted by the Director and all outstanding fees owed to the City (i.e., plan review and inspection fees) have been paid.

Final quantities will be determined by field measurement, observed jointly by the City Inspector, the Contractor, and the Applicant or his designated agent. Unit prices prepared for fee and bond calculation and authorized in City Code shall be used as a basis for cooperative work. The Director may negotiate unit or lump sum prices for items not usually encountered, or for unusual field conditions.

A. In Lieu Fees

When an in-lieu fee is required, or an allowable option in lieu of constructing improvements, the Consulting Engineer shall provide a written estimate of probable costs for the improvements based on a publicly bid project using prevailing wages assuming the City will construct the improvements. This written estimate shall contain all backup to quantity calculations and utilize current unit prices from publicly bid projects unless otherwise authorized by the City. The written estimate shall be signed and stamped by a licensed civil engineer and submitted to the City for approval. The estimate shall also include escalation using the same escalation method as the Roadway Fee Program.

4-3. STREET DESIGN STANDARDS

Unless required otherwise by the Rural Road Standards or an approved Specific Plan, the minimum street design and geometric standards must conform to Table 1, Street Design Parameters.

TABLE 1
Street Design Parameters

Parameter	Minor Residential ⁽¹⁾	Primary Residential ⁽²⁾	Collector ⁽³⁾	Minor Arterial	Major Arterial
Right-of-Way Width	42 feet	40 feet	50 feet	74 feet +	96 feet +
BOC to BOC Width	32 feet	38 feet	50 feet	74 feet +	96 feet +
Sidewalk Width	5 feet (attached)	5 feet (detached)	5 feet (detached)	8 feet (detached)	8 feet (detached)
Landscape Strip/Corridor Width	None	6 feet	6 feet	25 feet	36 feet
Number of Travel Lanes	2	2	2	4	6+
Travel Lane Width	No Center Stripe	No Center Stripe	12 feet	11 feet (12' inside)	11 feet (12' inside)
Median/Turn Pocket Width	None	None	10 feet	12 feet	12 feet
Bike Lane Width	None	None	5 feet	5 feet	5 feet
On-Street Parking Allowed	Yes	Yes	No	No	No
Design Speed	25 mph	25 mph	35 mph	45 mph	50 mph
Stopping Sight Distance	150 feet	150 feet	250 feet	360 feet	430 feet
Centerline Radius (Min.)	200 feet	350 feet	500 feet	1,500 feet	2,000 feet
EP Radius at Intersections (Min.) ⁽⁴⁾	28 feet	28 feet	33 feet	33 feet	33 feet
Traffic Index (Min.)	6.0 ⁽⁵⁾	6.0 ⁽⁵⁾	7.0	9.0	10.0
Structural Section	4" AC 13" AB	4" AC 13" AB	4" AC 16" AB	5.5" AC 21" AB	6.5" AC 23" AB
Structural Section w/LTSB	4" AC 6" AB 9" LTSB	4" AC 6" AB 9" LTSB	4" AC 6" AB 11" LTSB	5.5" AC 7" AB 13" LTSB	6.5" AC 8" AB 16" LTSB

Notes:

- (1) servicing < 100 residential units
- (2) servicing between 100-400 residential units
- (3) for Residential, Multi-Family, Commercial and Industrial
- (4) when streets intersect with wider streets, the wider street requirements apply

Definitions:

- BOC = Back of Curb
- EP = Edge of Pavement
- LTSB = Lime Treated Subbase

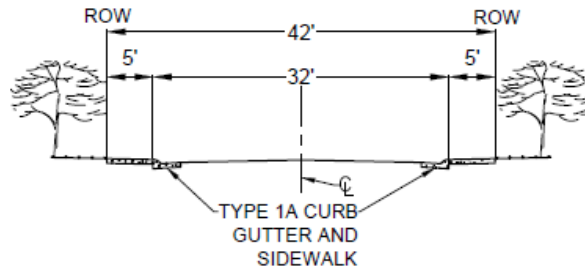

MINOR RESIDENTIAL
42' RIGHT OF WAY (TYPICAL)
NOT TO SCALE

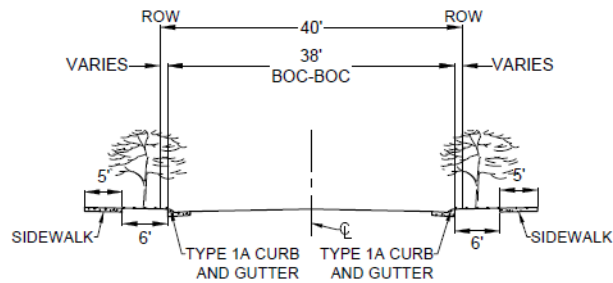

PRIMARY RESIDENTIAL
40' RIGHT OF WAY (TYPICAL)
NOT TO SCALE

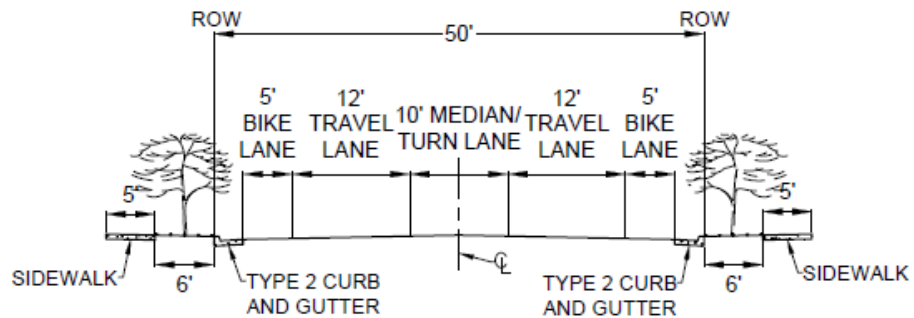

COLLECTOR
50' RIGHT OF WAY (TYPICAL)
NOT TO SCALE

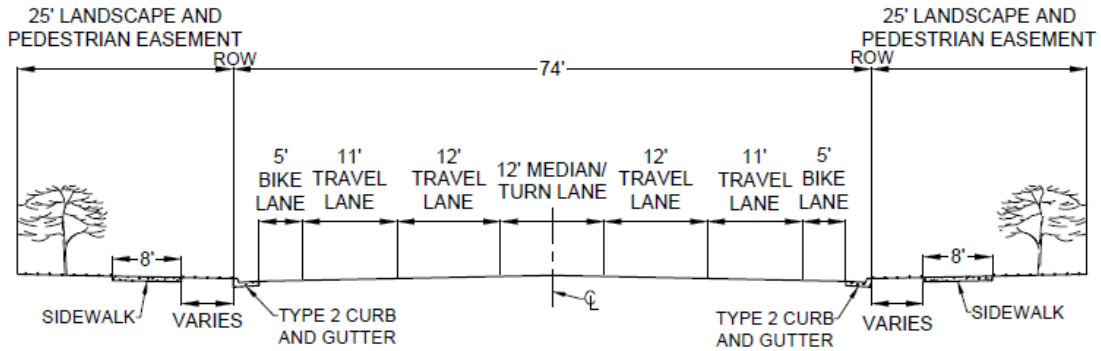

MINOR ARTERIAL
74' RIGHT OF WAY (TYPICAL)
NOT TO SCALE

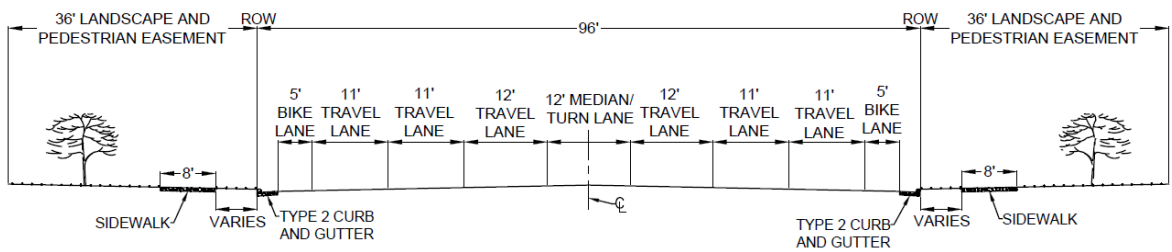

MAJOR ARTERIAL
96' RIGHT OF WAY (TYPICAL)
NOT TO SCALE

4-4. STANDARD PLANS

The City maintains a large library of Standard Drawings. All details must be in accordance with these Standard Drawings unless written deviation is requested from the applicant and approved by the City.

4-5. STRUCTURAL SECTION

The following standards for the design of structural sections shall govern the preparation of plans for proposed improvements.

- A. Structural sections for all asphalt roadways shall conform to Table 1 or shall be designed to conform to the California Department of Transportation Highway Design Manual (Latest Edition), "Topic 608 - Asphalt Concrete Pavement Structural Section Design", as modified from time to time, or other method as approved by the Public Works Director. The gravel equivalent safety factor of 0.2 feet of asphalt concrete shall be used for design. Calculated asphalt thicknesses shall be rounded up to the nearest ½ -inch increment and calculated aggregate base thicknesses shall be rounded up to the nearest 1-inch increment.
- B. Geotextile fabric, meeting the AASHTO M228-96 Geotextile Specification for Class 1 geotextiles, see Table 4.1, shall be placed between the basement soil and the aggregate base material in all streets.

Table 4.1 AASHTO M228-96 Geotextile Specification for Class 1 Geotextile			
Geotextile strength Property Requirements			
Property	ASTM Test Method	Class 1	
		Woven	Nonwoven
Grab Tensile Strength	D 4632	1400 N (315 lbs)	900 N (202 lbs)
Seam Strength	D 4632	1260 N (283 lbs)	810 N (182 lbs)
Trapezoidal Tear Strength	D 4533	500 N (112 lbs)	350 N (78 lbs)
Index Puncture Strength	D 4833	500 N (112 lbs)	350 N (78 lbs)
Mullen Burst Strength	D 3786	3500 N (508 lbs)	1700 N (247 lbs)

- C. If the subgrade has an R-value of 30 or less, the installation of pavement edge drains at least 12" deep shall be required on both sides of the street, located at the back of curb, for all streets unless allowed by Section D below. Drain design to be submitted by Consulting Engineer, for City approval by the Director.
- D. With approval by the Director, the subgrade soil beneath the curb & gutter and pavement section may be lime treated per geotechnical recommendations in lieu of the geotextile fabric and edge drain requirements noted above. When lime treatment is used, the street structural section shall be determined based on a three layer section using a gravel equivalent factor no greater than 1.1 and an R-value no greater

than 50 for the lime treated sub-base layer. However, the thickness of the aggregate base layer shall be no less than six inches under any circumstance.

- E. A soils report indicating the "R" value of the basement (i.e., subgrade) soil, along with calculations for structural pavement sections shall be submitted with any plan indicating construction of roadway.
- F. Portland cement concrete streets may be constructed with the approval of the Director.
- G. The use of alternate road building materials will be allowed if supported by a sound pavement design study prepared by a registered civil (or geotechnical) engineer and approved by the Director. These alternate road building materials may include but not be limited to the following:
 - Pavement stress absorbing interlayers
 - In-situ soil and subgrade stabilizing admixtures
 - Reclaimed Asphalt Pavement (RAP)
 - Rubberized asphalt concrete
 - Roller compacted concrete
- H. In transition areas from one street width to another street width standard, the heavier structural section shall be used in the transition area.

4-6. HORIZONTAL AND VERTICAL STANDARDS

The following standards for the design of profiles shall govern the preparation of plans for proposed improvements.

- A. All minimum vertical sight distances shall be based on Chapter 200 of the Caltrans Highway Design Manual.
- B. The minimum grade on new streets shall be 0.35% except that the minimum curb and gutter grade around intersection corners shall be 0.50%.
- C. The minimum grade of gutter sections constructed on existing streets shall be 0.25%.
- D. Standard cross slope on new streets shall be 2.0%.
- E. The minimum cross slope on street widening shall be 1.5% and the maximum cross slope shall be 3.0%. The cross slope of the widening shall conform to the cross slope of the existing pavement whenever possible.
- F. When two streets intersect, neither street shall have a longitudinal grade greater than 3.0% for a minimum distance of 40 feet measured from the back of curb line of the intersecting street, except in unusually rough terrain, as determined by the Director. At all street intersections, the centerline crown of the lesser roadway width shall meet the surface pavement elevation of the intersecting roadway at a point along the projected lip of gutter of the larger roadway. If both roadways have the same street width, the larger roadway shall be the street with the higher projected

traffic volume with full land development. Crown slope may be reduced to 1.0% within the intersection, if necessary.

- G. The minimum vertical curve length allowable at the intersection of two grades shall be 50 feet. Vertical curves on residential and collector streets may be omitted where the algebraic difference in grades does not exceed 2.0%. Vertical curves on all other streets may be omitted where the algebraic difference in grades does not exceed 1.5%. The minimum vertical curve data to be computed and shown on the plans shall consist of the point of intersection elevation, the tangent gradients, the middle ordinate and the length of curve.
- H. **HORIZONTAL CURVES:** Minimum horizontal curves shall be as shown in Table 1, Street Design Parameters. A minimum tangent length of 200 feet is required between reversing curves on 50-foot back of curb to back of curb and larger streets.

4-7. INTERSECTIONS AND DRIVEWAYS

- A. All streets shall intersect at $90^{\circ} \pm 5^{\circ}$ angle to each other. This angle shall be maintained for a minimum distance equivalent to the right-of-way width measured from the curb return.
- B. Streets shall not be designed to intersect on the inside of a horizontal curve nor on the opposite side of a crest vertical curve if the sight distance will be inadequate for drivers to enter the traffic flow or cross the street safely.
- C. Streets intersecting any 42-foot, 46-foot or 48-foot residential street from opposite sides shall have their centerlines meet, or the offset between intersections shall be a minimum of 150 feet.
- D. Streets intersecting any 50-foot back of curb to back of curb, or 66-foot street from opposite sides shall have their centerlines meet, or the offset between intersections shall be a minimum of 200 feet
- E. Streets intersecting any 72-foot street from opposite sides shall have their centerlines meet, or the offset between intersections shall be a minimum of 300 feet. Pursuant to this section major access driveways shall be considered as streets with respect to offsets.
- F. **ELBOW INTERSECTION:** Elbows shall be required at right angle intersections in accordance with the Standard drawing ST-25.
- G. **DRIVEWAYS:** Driveway installation shall be in accordance with the Standard Drawings as applicable, and the following:
- Driveways entering Class "B" or Class "C" streets shall meet the property line at such a grade and elevation as to permit conversion to a Class "A" street without re-grading the driveway beyond the property line. The maximum driveway slope shall be 10%, except for single family and duplex driveways, and in unusual terrain conditions, when specifically approved by the Director. The maximum

algebraic difference in grade at any grade change within the public right-of-way and a driveway or between a driveway and public roadway shall be 10%.

- Concrete driveways will not be permitted within the right-of-way lines when entering Class "C" streets. (See Standard drawing ST-19.)
- No driveway (including transition tapers) will be allowed within 5 feet of a side property line (See Standard drawing ST-22.) Joint driveways may be required by the Director and a reciprocal access agreement will be required prior to approval of improvement plans.
- Driveways and intersections on arterials and thoroughfares shall be evaluated for right turn pockets. Driveways and intersections which have at least 25 right-turning trips in the peak hour shall have a right turn pocket into the development. Projects with less than 25 right-turning trips in the peak hour at the driveway or intersection shall be evaluated on a case by case basis. Right turn pockets shall have 90' bay taper. Pocket lengths shall be evaluated on a case by case basis based upon traffic volumes and other relevant considerations.
- For all 72-foot streets and wider, driveway throat depths shall be a minimum of 50' from the back of the sidewalk, clear of drive aisle or parking spaces. Longer throat depths may be required based upon traffic volumes generated and the traffic volume on the street the project is accessing. All driveways, except those providing access to single family residential uses, on two lane streets shall have a minimum throat depth of 25 feet.
- The minimum width for a single family residential or duplex driveway shall be 10 feet. The maximum single family residential or duplex driveway width shall be 24 feet. For dwellings that provide three car garages, (side by side garages only) wider driveways may be evaluated and approved on a case by case basis
- All commercial and multiple family developments shall install driveways consistent with the standard drawings. (See Standard drawings ST-20.) Commercial, office and multi-family driveways on collector streets shall have a minimum opening of 24-feet and may be increased, as determined by the Director to 35-feet wide based upon the driveway vehicular volume, street geometrics, street vehicular volumes or other characteristics of the area. Driveways serving significant truck traffic may be increased to a 45-foot wide driveway opening, at the discretion of the Director.
- The standard multiple family and commercial driveway opening width shall be 35 feet on 72-foot, 96-foot, and 118-foot streets and may be increased to 45 feet at the discretion of the Director. Driveways on 72-foot, 96-foot, and 118-foot streets shall have a minimum clear spacing of 200 feet between driveways (See Standard drawing ST-22.).
- A center median up to 10 feet wide may be approved by the Director for certain driveways. The normal driveway width will be increased by the median width.

- Driveways near major intersections shall be located outside of the widened area at expanded intersections and shall be located as shown on Standard drawing ST-22.
- The standard driveway for industrial developments shall be Type A-6 or Type A-7, 45 feet wide, as shown on the Standard drawings ST-20 and ST-21A.
- When driveways are abandoned or relocated, the driveway sections must be removed and replaced with standard curb and gutter, sidewalk, and if applicable, planters.
- When street frontage improvements exist with, Type 1A, or Type 2 curb and gutter, Type A-6 or A-7 driveways shall be installed for all accesses serving more than four single dwelling units.
- Driveways entering levee roads and driveways entering commercial property on all roads shall have a slope not exceeding 5% for a minimum distance of 20 feet, measured from the edge of existing pavement. Driveways normally used by vehicles towing house or boat trailers shall have special requirements to be determined on an individual basis by the Director.
- The nearest edge of driveways shall not be closer than 50 feet to the end of existing or future traffic medians. Medians shall be reconstructed and/or lengthened to conform to this section if necessary, as determined by the Director.
- Visibility requirements for driveways shall be in accordance with the Section 4-8 and Standard drawings ST-26.1 and ST-26.2. Increased visibility requirements may be required for driveways serving a significant amount of truck traffic.
- Major commercial driveways which will serve significant traffic volume, as determined by the Director, shall be considered as intersecting streets and shall conform to the same offset requirements.
- Driveways accessing public streets with no curbs and gutters and sidewalks shall be paved with dust free surfacing (either asphalt concrete or a double chip seal). Driveways accessing public roads with sidewalks and/or curbs and gutters shall be paved with concrete or asphalt concrete. (See Standard drawing ST-19.)
- Private streets must be designed and constructed to public street standards, per the City of Elk Grove General Plan.
- Residential driveways on minor street or collector streets at their intersection with a 50-foot back of curb to back of curb or narrower street shall be located a minimum of 15 feet clear from the corner return. Residential driveways on minor street or collector streets at their intersection with a street wider than 50-foot back of curb to back of curb shall be located a minimum of 50 feet clear from the corner return. Non-residential driveways on a collector street intersecting with a 72-foot street or wider shall be located a minimum of 150 feet clear of the corner return. (See Standard drawing ST-22.)

4-8. SIGHT DISTANCE AND VISIBILITY EASEMENTS AT INTERSECTIONS

For streets having, or intersecting with a street having, an ultimate width of 48 feet or greater (measured from back of curb to back of curb), The minimum stopping sight distance at intersections and non-residential driveways for establishing visibility control areas shall be as shown in Table 1, Street Design Parameters (also see Standard drawing ST-26.1)

For other cases, the following visibility control standards shall apply:

- Streets with an ultimate width of less than 48 feet (measured from back of curb to back of curb) shall be consistent with Standard drawing ST-26.2.
- 90-degree intersection elbows shall be consistent with Standard drawing ST-25.
- Residential driveways shall be consistent with Standard drawing ST-26.2. Residential driveways off of collectors, arterials or thoroughfares may be subject to the minimum sight distance requirements set forth above, as determined by the Director.

Regardless of the street width, driveways serving significant traffic volumes, as determined by the Director, shall be subject to the minimum sight distance requirements for major street intersections.

All existing streets that do not intersect at a $90^{\circ} \pm 5^{\circ}$ angle to one another shall be subject to the minimum sight distance requirements for major street intersections when enforcing the visibility control area.

No signs, plantings, structures, natural growth, fences, walls or any other type of obstruction to a clear view, higher than 3 feet above the nearest pavement surface (or traveled area where no pavement exists) shall be installed or maintained or shall be permitted to be installed or maintained within the visibility control area. Exceptions include tree canopies, signs that provide a minimum clearance of 7 feet measured from the existing grade, or permanent structures existing as of the effective date of these provisions.

Dedication of visibility easements may be required over the visibility control areas to ensure that the required sight distances can be enforced and maintained. Visibility easements for residential driveways are not required unless the Director determines that the dedication is necessary to satisfy special safety considerations. Visibility easements shall be recorded on final maps or by separate instrument if a map is not required.

4-9. INTERSECTION CORNER RADII AND BULB-OUTS

Minimum right-of-way and edge of pavement radii for intersection corner roundings shall be in accordance with the Standard Drawings and Table 1, Street Design Parameters

When two streets of different widths intersect, the radius for the narrower street shall apply, except that when a 48-foot street intersects a wider street, the radius for the wider street shall apply.

All intersection pavement edges on Class "C" streets shall have a minimum radius of 35 feet where widening is not required by Section 4-3(J) (See also Standard drawing ST-18).

All intersection pavement edges on partial streets shall have a minimum radius of 25 feet or greater, as determined by turning requirements at the subject location, on the uncompleted side.

Bulb-outs shall conform to the geometry shown on Standard drawings ST-24 and shall be installed as required by conditions of approval or as deemed necessary by the Director.

4-10. CUL-DE-SAC

Cul-de-sac streets shall be terminated with a bulb, which shall have right-of-way and back of curb radius dimensions conforming to the Standard drawing ST-23 and the following:

No cul-de-sac shall exceed 600 feet in length, measured as the distance from the centerline of the intersecting street to the center of the cul-de-sac bulb.

The minimum T.I. for a cul-de-sac shall be 6.5. Special T.I.'s will be provided to the consultant engineer for industrial cul-de-sacs or where other special conditions exist.

Where there is no vehicular access from the end of a public street, the street must be terminated with a bulb. A Fire Department approved turn-around will be considered as an alternative to a cul-de-sac for private streets where no vehicular access is taken from the end.

Where possible a pedestrian connection should be provided from the bulb end of a cul-de-sac to the nearest neighboring roadway.

4-11. PARTIAL STREET

Partial streets may be permitted by the Director along the boundary of a subdivision or property of the Applicant where the full right-of-way cannot be dedicated or where the complete street cannot be constructed, but will ultimately be constructed with adjacent development.

The minimum right-of-way width shall be 40 feet or one-half of the proposed right-of-way, whichever is greater. Lesser right-of-way widths may be allowed when approved by the City Council in accordance with the State of California Streets and Highways Code.

Partial streets shall be constructed to a complete geometric and structural section and have a minimum paved width specified by the following:

- On 42, 46 and 48-foot streets, the minimum pavement width shall be 26 feet.
- On 50-foot b/c to b/c streets, the pavement shall extend five feet past centerline for a total of 27 feet.
- On 66-foot streets, the pavement shall extend five feet past centerline for a total of 30 feet.

The intersection pavement edges shall have a minimum radius of 25 feet for any corner return that lacks curb & gutter at an intersection of residential and/or collector streets.

The minimum radius of a corner return of an intersection that includes either an Arterial or a Thoroughfare roadway is 35 feet.

When paving partial construction of an ultimate street development, the edges of the current pavement on the uncompleted side are to be protected by use of 2"x6" approved headers, construction grade, or by placing a minimum of 1-foot additional width of aggregate base material beyond the edge of pavement to the grade and depth of the adjacent structural section.

Partial streets shall be terminated with the end of the pavement perpendicular to the street unless otherwise specified below. A 2"x6" redwood header board shall be required at the pavement ending.

Partial streets that terminate adjacent to an intersection or driveway shall be tapered 45 degrees to the street if right-of-way is available.

The end of a partial street that terminates a traveled lane in the direction of travel shall have the travel lane tapered in accordance with the following equations:

Less than 45 mph, $L = WS^2/60$

Greater than or equal to 45 mph, $L = WS$

Where L = Length, W = Width (feet) and S = Design Speed (mph)

The design speed used in determining the taper shall be that given in the table in Section 4-7(F).

The Director may specify alternate pavement tapers for the termination of partial streets.

4-12. BUS STOP

Bus stop turnouts with paved shelter pad areas shall be required at approximately ¼ mile intervals along Arterial and Thoroughfare streets where specified by the Director. Bus stop turnouts may also be required on Collector streets as determined by the Director.

At all intersections of 72-foot, 96-foot, and 118-foot streets with other 72-foot, 96-foot and 118-foot streets, bus stops shall be provided with turnouts that are integrated with standard intersection widening in accordance with the Standard drawings ST-11 through ST-15B.

General principles related to bus stop turnouts include:

- Bus stop turnouts shall be located on the far right hand side of intersections, unless otherwise required by the Director, in accordance with the Standard drawings ST-11 through ST-15B and ST-27.
- Where intersections are too widely spaced to provide satisfactory bus stop intervals, as determined by the Director, mid-block bus stops and turnouts may be required. Sidewalks shall be 6 feet wide at bus stops with a 7-foot by 28-foot

P.C.C. pad to accommodate bus shelters as shown on the Standard drawings ST-27 through ST-28.

- Reinforced Type 2 curbs shall be required at all bus stops and turnouts in accordance with the Standard drawing ST-28.

4-13. SIDEWALK RAMP AND ACCESSIBILITY IMPROVEMENTS

Sidewalk ramps shall be constructed at all street intersections and at other locations where required by the Director, in accordance with the Standard Drawings, as applicable.

All intersection corners shall have dual sidewalk ramps, unless dual ramps are determined by the Director to be undesirable or impractical (e.g., where dual ramps would result in large crosswalk skews, where visibility concerns exist at stop-controlled intersections, or intersections where the major street has a raised median extending through the intersection).

At “T” intersections, ramps are not to be placed to facilitate crossing of the through street unless the Director determines that special conditions exist (e.g., where the intersection is adjacent to land uses having special pedestrian generating characteristics such as parks and schools).

In accordance with the requirements of the Americans with Disabilities Act (ADA), any modification of any portion of an intersection may require access improvements to all corners of that intersection as determined by the Director based on the nature of work being proposed at the intersection. For the purpose of this requirement, modifications include but are not limited to:

- Roadway widening through the intersection
- Widening of a portion of the intersection
- Construction of corner improvements (curbs, gutter, and/or sidewalks) in any portion of the intersection
- Construction of a new traffic signal
- Modification of an existing traffic signal

Resurfacing the pavement with an asphalt concrete overlay in any portion of the intersection

Access improvements to the intersection include, but are not limited to, the construction of sidewalk ramps. Should there be existing sidewalk ramps prior to the modification of the intersection, it shall be the responsibility of the Applicant to survey the existing sidewalk ramps to ensure that they comply with the current requirements of the ADA for existing ramps. Should any existing ramp fail to meet those requirements, that ramp shall be removed and replaced with a sidewalk ramp that conforms to City ADA standards. Refer to Standard drawings AR-2.0 through AR-4.8.

If an intersection is modified, as defined above, and if that intersection has an existing traffic signal, access improvements shall include the installation of ADA compliant

pedestrian push buttons, should they not exist. Those push buttons shall conform to the ADA and City requirements including height, orientation, location relative to sidewalk areas, locations relative to sidewalk ramps and location relative to crosswalks (Refer to Standard drawing T-19). Access improvements for such intersections shall also include the installation of audible pedestrian traffic signals.

Improvements associated with trail and pedestrian crossings at mid-block locations shall be designed in accordance with these Improvement Standards, the *City of Elk Grove Bicycle, Pedestrian, and Trails Master Plan*, and the National Cooperative Highway Research Program (NCHRP).

4-14. CURB AND GUTTER

Curb and gutter shall be installed or replaced adjacent to all developments, excepting Class "C" Streets, in accordance with the Standard drawing ST-31 and the following:

- A. Type 1A Curb and Gutter: 42-foot, 46-foot and 48-foot streets, only along segments where continuous single family residential units are proposed for front-on access, or as required by the Director.
- B. Type 2 Curb and Gutter: All streets not covered under A. above.

4-15. CROSS GUTTER

Cross gutters may be permitted on 42-foot, 46-foot and 48-foot streets with the specific approval of the Director when the intersection cannot reasonably be drained to an underground system. (See Standard drawing ST-32.) No cross gutter will be allowed on 50-foot or greater streets. Cross gutters will also not be allowed on any approach to a signalized intersection.

4-16. BARRIER CURB

Barrier curbs shall be in accordance with Standard drawings ST-31 and ST-33 (Type 3, 4, or 5). Barrier curbs shall be required at all locations where parking will be allowed adjacent to the sidewalk. See Standard drawing ST-33 for planter and barrier curb details (lawn may extend to the back of sidewalk in lieu of planters).

A barrier curb shall be required at the back of sidewalk at all commercial, industrial, and multi-family residential properties and landscape corridors where landscape planters containing soil and/or mulch are adjacent to the sidewalk. A barrier curb is not required at the back of sidewalk adjacent to lawn.

A barrier curb shall be required at bus stops behind a sidewalk where the slope is toward the sidewalk (to prevent sheet flow across the sidewalk). Under sidewalk drains shall be used to remove drainage collected at the back of the barrier curb, as necessary to prevent any flow across the sidewalk. (See Standard drawings ST-34.)

A barrier curb shall be required behind a sidewalk where the slope behind the sidewalk is greater than 6:1 and the slope is away from the sidewalk (for pedestrian safety). Where a retaining wall is allowed, creating a drop-off adjacent to the sidewalk, a minimum 36-inch high barrier fence is required in lieu of the barrier curb at the back of the sidewalk. Lot

grading shall be done so as to not require fencing immediately adjacent to intersections and driveways in violation of the sight distance and visibility requirements of Standard drawing ST-26.2 and Section 4-14.

4-17. SIDEWALKS

Sidewalks shall be in accordance with these Standards and the geometry shown in the Standard Drawings. Sidewalks within landscape corridors adjacent to Collector, Arterial, and Thoroughfare streets shall conform to the Adopted Citywide Design Guidelines and Standard drawing ST-35.

All school and park developments shall have 8-foot attached sidewalks along all frontages.

For standard sidewalks separated from the roadway curbing by a landscaped buffer, no utility pole, guy wire, cabinet, hydrant, sign or other above ground facility shall be located within the sidewalk area, where possible. Where utility poles and other obstructions are situated within the planned sidewalk section, a minimum of 4 feet of clear uninterrupted sidewalk area shall be provided. Where it is necessary to widen the sidewalk beyond its standard width to attain the 4-foot clearance, the widened area shall extend a minimum of 5 feet beyond each side of the obstruction and a 10-foot taper on each side of the widening shall be required. Traffic signal poles may be located with sidewalk areas to allow for pedestrian access to pedestrian push buttons, however four-foot minimum pedestrian clearance around poles must be provided on the sidewalk.

For standard sidewalks that are attached to the roadway curbing (monolithic), all utility poles, guy wires, cabinets, hydrants, signs and other above ground facilities shall be located behind the sidewalk, within the easement for public utilities and public facilities, where possible. If such is not possible, the conflicting facility shall be located such that there is a minimum of four feet clear space for pedestrian use of the sidewalk. Where it is necessary to widen the sidewalk beyond its standard width to attain the 4-foot minimum clearance, the widened area shall extend a minimum of 10 feet beyond each side of the obstruction and a 10-foot taper on each side of the widening shall be provided.

Where sidewalks end within infill areas and a gap in the sidewalk exists, provided that right-of-way is available, temporary sidewalks shall be constructed to fill the gap to the satisfaction of the Director. Otherwise the sidewalk shall be extended beyond the end of the property for a minimum distance of 6 feet or if approved by the Director a cut-off wall may be constructed at the end of the sidewalk and appropriate connection to the existing public street shall be provided for pedestrians traveling beyond the end of the sidewalk.

The meandering sidewalks will be designed to the specifications in Standard drawing ST-35. For Case I, the sidewalk will have at least a 2-foot wide straight path down the center and a 10-foot minimum distance at the back of walk between landscaped areas. A Type 2 curb & gutter shall be required along the entire length of meandering sidewalk. For Case II, the sidewalk will have no abrupt changes in direction and will be constructed using only tangents of any length and inside radii of at least 150 feet. Type 2 curb & gutter shall be required at all locations where the sidewalk is separated from the curb. The Director may approve other configurations of meandering sidewalks to save existing trees or for special design applications.

4-18. PEDESTRIAN LANES AND TRAILS

Pedestrian lanes and trails within a development shall conform to the current version of the City's Bicycle, Pedestrian, and Trails Master Plan and these Standards.

Bollards placed as trail entrance barriers shall conform to Standard drawings L-21 and L-22.

4-19. TRENCHING IN EXISTING PAVED ROADWAYS

Crossings, other than perpendicular crossings of existing roadways, and all trenching in high traffic locations shall provide for select backfill material and increased structural section depth over the standard for that particular roadway. Boring may be required on 72-foot, 96-foot, and 118-foot streets where, in the opinion of the Director, high peak hour traffic volumes or other unusual conditions exist. The Applicant shall be required to coordinate trenching work schedules to avoid cutting new pavement in instances where repaving is planned by the City.

No pavement cuts or trenching will be permitted on any street that has been constructed within the last five years or has been overlaid within the last three years without written special approval of the Director. Special pavement restoration will be required for cuts made in streets that have been constructed or overlaid within a period of five or three years, respectively, prior to the time of work. See Standard drawings ST-1 through ST-10.

4-20. TESTING OF MATERIAL

Testing of materials to be utilized in work performed under the Standard Construction Specifications shall be performed in accordance with the methods of the Laboratory of the State of California, Department of Transportation. Signed copies of the test results, as required, shall be submitted to the Director. Test results shall show clearly the name of the individual and firm performing the tests, as well as the name of the project, the date of sampling, and the date of testing. Tests performed by the City will be charged to the Applicant as part of inspection billing.

The tests indicated in the Standard Construction Specifications will be the minimum required. In large developments, or those developments presenting special problems, a more comprehensive and extensive testing program may be required. Such conditions will be evaluated and an appropriate testing program prescribed on an individual basis. Two copies of any Federal Housing Administration required soils tests shall be submitted with proposed plans.

4-21. STREET NAME

All roads and streets within a development shall be named by the Applicant subject to the approval of the Director. No duplication of names already in use or previously proposed will be permitted. Sound-alike names or names with more than 13 spaces are not acceptable. Street names at intersections shall be continued on both sides of the intersecting streets unless approved by the Director.

Street name signs shall be furnished and erected by the Applicant. Street name signs shall conform to the requirements of the Standard Construction Specifications and these Improvement Standards.

Street names and street name sign locations shall appear on plans submitted for approval. Sign details shall be as shown on the Standard drawings T-3 and T-4.

Block numbering shall be required on all street name signs.

Private roads shall have street name signs installed in accordance with Section 4- 26(B) below. Street name signs for private roads may be the same as for public streets (see Standard drawing T-3) except the words City of Elk Grove must be omitted. Also, a separate additional sign must be placed on the same post saying "Not a City Road" which shall be 9 inches wide, 8 inches high, and have 1-3/4 inch high white letter on a green background.

4-22. STREET SIGN LOCATION

Street sign locations shall conform to the following:

- A. Two street name sign installations (with four sign plates on each post) are required at each intersection where one or both of the intersecting streets has a right-of-way width of 72 feet or greater. At a four-way intersection, the installations shall be located on both far right-hand corners of the intersection relative to the street having the greater right-of-way width or relative to the street with greater traffic volume if right-of-way widths are equal.

At a "T" intersection, the first installation shall be located on the far right-hand corner of the intersection, relative to the through street, and the second installation shall be located adjacent to the through street at a point in line with the centerline of the terminating street. One sign plate shall be omitted from the standard four-plate installation at the "T" intersection sign locations where an approach street does not exist.

- B. One street name sign installation (with four sign plates on each post) is required at each intersection where both intersecting streets have a right-of-way width of less than 72 feet. At a four-way intersection, the installation shall be located on one of the far right-hand corners of the intersection relative to the street having the greater right-of-way width or relative to the street with greater traffic volume if the right-of-way widths are equal. At a "T" intersection, the installation shall be located on the far right-hand corner relative to the through street.
- C. For highways with frontage roads, the street name sign installations shall be located in the divider strip between the frontage road and the main traveled lanes of the highway. All other requirements shall be as outlined above, except that only one sign will be required (in the divider strip in line with the centerline of the minor street) when there is no opening in the divider strip for access to the main highway.
- D. Standard drawings T-5A, T-6A, and T-6B show placement details for street name signs. On streets having a right-of-way width of 72 feet or greater, the street name

sign installations are to be located adjacent to the street with greater traffic volume at the end of the curb return. On streets with right-of-way widths less than 84 feet, the street name sign installations are to be located at the midpoint of the curb return.

- E. Street name signs shall be placed on streetlight poles wherever possible, in accordance with Standard drawings T-5B.
- F. At signalized intersections, street name signs shall be placed on all four corners of four-legged intersections and at three locations on "T" intersections. In addition, internally illuminated street name signs are to be installed on their own clamp-on steel mast arms, 9'-3" in length, 3-5/8' in diameter, mounted at the 27-foot level.

4-23. TRAFFIC SIGNS

All cul-de-sac and dead-end (stub) streets greater than 300 feet in length and all cul-de-sac and dead-end (stub) streets less than 300 feet in length where the curb at the centerline of the end of the street is not visible from the standard driver's eye position at the entering intersection shall be posted with a standard 24" x 24" "Dead End" (W14-1) sign. The bottom of the sign shall be a minimum of 7 feet above the sidewalk. The standard location for the W14-1 sign is on the right hand side at the tangent point of the corner rounding, 6 inches (minimum) from the back of sidewalk. Consideration shall be given to property lines and street light locations when determining the final location of the sign.

All Fire Department approved turn-arounds on street ends shall be posted with a standard 24" x 24" "End" (W31) sign, and a standard 18" x 18" red Type N marker. The red Type N marker shall be mounted below the W31 sign, on the same post. The top of the red Type N marker shall be a minimum of 4 feet above the sidewalk. The standard location for the W31 / red Type N installation is in the head on position, facing traffic, approximately 3 feet to the right of the prolongation of the street centerline, 6 inches (minimum) from the back of sidewalk.

All roads and streets within a development and new street frontage improvements shall include necessary traffic signs and pavement striping and shall be installed by the Applicant. Applicant may request City forces to install traffic signs and striping at Applicant expense. The Applicant shall not proceed to open the roads or traffic lanes until required traffic controls are in place and traffic safety is ensured. Traffic signing and striping shall conform to the City of Elk Grove Standard Specifications. A traffic signing and striping plan, if applicable, shall be included in the plans submitted for approval by the Director.

4-24. PERMANENT BARRICADE

Where improvements are temporarily terminated on a street proposed to be extended in the future, the improvements shall include a permanent type barricade at the end of the street extending completely across the right-of-way to prohibit access and to serve as a warning to the public. The barricade shall be constructed, erected, painted, and signed in accordance with Standard drawing ST-41 through ST-43. When necessary, barricades may be lengthened by making the 2" x 12" plank continuous with splicing at the posts.

Gates may be required where streets stub into public park areas or like areas.

Timber barricades with SW-44 signs and Type "L" markers in accordance with the Standard drawing ST-42 shall be required where partial street widening terminates at the far end of the widening in the direction of traffic. If the ground beyond the pavement constriction is free of fixed objects and relatively flat, the Director may approve the placement of delineators on 6-foot spacing as shown on the Standard Drawing in lieu of a timber barricade and signs.

Sidewalk barricades shall be constructed at the end of sidewalks where pedestrians cannot safely continue beyond the end of the sidewalk. Sidewalk barricades shall conform to Standard drawing ST-43. Where sidewalks improvements are terminated, an A.C. sidewalk conform shall be constructed in accordance with the Standard drawing ST-36. A permanent barricade shall also be constructed at the end of A.C. sidewalk conform if the conform abuts a drainage ditch, a fill slope steeper than 1:20 or other surface that would pose a hazard to pedestrians.

4-25. FENCES

The location for fences or walls along public streets shall conform to the requirements of the City of Elk Grove Zoning Code and these Standards (Refer to Section 6, 'Sound Barrier Design"). Fences or walls shall not encroach upon visibility easements required by Section 4-8 and Standard drawings ST-26.1 and ST-26.2. All fences and walls are subject to the visibility requirements of the City of Elk Grove Municipal Code (Title 12).

Fences and walls may require modification to accommodate street light poles and/or foundations.

When a barrier fence is required by the conditions described in Section 4-20, "Barrier Curb," the barrier fence shall be three feet high, shall be chain link type or another type required by the Director, shall be placed at the back of sidewalk, and shall conform to the visibility requirements described herein.

4-26. PRIVATELY OWNED BRIDGE

A bridge intended for the sole use of the occupants of a multi-family type development or any bridge on a private road shall be designed to withstand the greater of an H-20 load and the loading conditions for fire trucks and garbage trucks. Other design features of the bridge, including but not limited to widths, railings, clearances and materials shall be in conformance with City and State Standards. A soil report prepared by a qualified soil engineer shall be required Along with design calculations signed by the Consulting Engineer including the registration number. Maintenance and operation of privately owned bridges shall be the responsibility of the private property owner.

4-27. VEHICLE ACCESS AT STREET TERMINATIONS

Vehicular access shall not be permitted from the end of a stubbed street. To obtain vehicular access, the street must be extended through the property or properly terminated with a standard cul-de-sac bulb. In cases where no access is provided at the

end of the street, the Director may approve a modified cul-de-sac (See Section 4-11 of these standards).

4-28. TRAFFIC CALMING DEVICES

Traffic Circles and Speed Lumps (*Pending further input and drawings*)

4-29. ROOT BARRIERS

For requirements regarding tree root barriers, see Section 23.54.040(C)(2)(d) of the City of Elk Grove Municipal Code.

SECTION 5
STREET LIGHT DESIGN

5-1. STREET LIGHTS REQUIRED

Street lights shall be required for all lots and parcels being developed or constructed upon unless excepted by Section 5-2. In addition, street lights may be required for lots and parcels containing existing structures which are being improved or altered, depending on the nature and extent of the work. Illustrations of street lights generally required are shown in the Standard drawings SL-1 to SL-47.

All Street lights must be powered by an metered service as approved by the Utility Company.

5-2. STREET LIGHTS NOT REQUIRED

Street lights shall not be required under the following circumstances:

- A. Single family residential subdivisions having an average lot street frontage of more than 125 feet will not be required to install a street light system along the streets but shall, as a minimum, be required to install street lights at all intersections, cul-de-sacs, and other locations described herein or deemed by the Director to be essential for safety.
- B. For planned residential, commercial, and industrial developments where the internal streets are not offered for dedication, a street lighting system will not be required for the internal non-dedicated streets, but shall be provided by the Applicant on the external public street frontage.

5-3. APPLICANT'S RESPONSIBILITY

Existing street lights which must be relocated or repositioned because of the construction of new streets or driveways into a development shall be the responsibility of the Applicant.

A new service enclosure with a step-down transformer, required because of the modification, replacement, or relocation of an existing utility service pedestal, shall be the responsibility of the Applicant. The Applicant shall also be responsible to ensure that power shall remain to existing street lights during the period of any such modification, replacement or relocation of an existing utility service pedestal.

It shall be the responsibility of the Applicant to ensure that the power shall remain to the existing street light system until the new street light system to replace it is completed and functioning correctly.

5-4. UTILITY COMPANY AUTHORIZATION

A written notice from the serving utility company, stating that line clearances and service have been checked and are adequate, shall be submitted to the Director for all developments.

5-5. GENERAL PLAN DETAILS

The plans shall show and identify all street lights to be installed, all existing lights in the immediate vicinity of the project, all conduit and conductor runs, service points, trees, and all applicable provisions and details specified in these standards.

On subdivision plans, the street lights shall be shown separately. In addition to the above, the following shall be required on the street light portion of subdivision plans, even though duplications may be involved:

- A vicinity map or equivalent
- Utility poles and public utility easements
- Names of adjacent subdivisions
- Intersecting property lines of adjacent properties
- A “Symbols” legend conforming to Standard drawing SL-1
- A north arrow and appropriate scale (1” =10’ to 1” =100’)
- All existing street lights on both sides of any streets
- All new tree installations shall be more than 10’ from street lights

5-6. DESIGN STANDARDS

Street lighting shall be designed in conformance with these specifications, the current edition of the City of Elk Grove Standard Construction Specifications, and the “American National Standard Practice for Roadway Lighting” of the American National Standards Institute, except that the average horizontal maintained foot candles for the various street classifications shall be as shown on Standard drawing SL-2. Data and calculations, including a photometric plan, supporting the satisfaction of the above requirements shall be submitted for review, or the predetermined design standards included herein shall apply.

5-7. STREET LIGHT TYPE

- A. Lighting Type Areas - Street light poles and fixtures shall conform to the designated type depending on the location within Elk Grove (See Standard drawing SL-19).
 - 1. Laguna West (LW) – Selected areas west of the Union Pacific Railroad alignment (approximately 300 feet west of Franklin Road); north of and including Elk Grove Blvd; south of and including Laguna Blvd; and east of Harbour Point Drive.

2. Old Town (OT) – Elk Grove Boulevard between Elk Grove-Florin Road and Waterman Road
3. Zone 2 – Area south of Elk Grove Boulevard; east of Bruceville Road; north of Kammerer and west of Route 99; excluding the Auto Mall area bounded by Laguna Grove Drive and Elk Grove Boulevard.
4. Common [non-decorative] (CT) – All other areas within Elk Grove.

Street lighting designs shall reference the type of light shown in the Standard Drawings and the City's Approved Equipment List for the project location.

B. Decorative Street Lights

1. Decorative streetlights must be approved during the planning process in the City General Plan or specific plan.
2. When decorative type streetlights are designated by type in these standards or in an approved City plan not yet incorporated into these standards, the Applicant shall supply additional complete streetlight assemblies (electrolier, luminaire, glassware, etc.) to the City for future street light replacement. The minimum number of replacement street lights (spares), by series and type, to be supplied to the City shall be 2% of the lights being installed with any fractional percent rounded up to the next whole number. Developments with less than 10 streetlights in total shall provide 1 spare. A note shall be included on the street light plan sheet indicating the requirement for spares as detailed above.
3. The Applicant shall be required to submit design calculations for the foundation, and pole spacing, including photometric calculations and plots from an appropriate computer program, if not already provided in these standards.

C. Equipment Type

Materials and equipment shall be purchased as required to meet these standards:

1. City's Approved Equipment List: The City has determined that for ensuring aesthetics and durability, minimizing inventory costs, and expediting repairs, standardization is in its' best interest and maintains an approved equipment list of specific manufactures and models to be used in particular zones.
2. Substitutions to City's Approved Equipment List: Substitutions will not be considered for a particular project. If a distributor or manufacturer has a streetlight product with the exact same visual appearance specified for a zone; it may submit the item to the City for evaluation. The City may take up to 90 days typically to consider a new streetlight manufacturer. The streetlight assembly will be evaluated against the criteria established by the Director. If the streetlight meets all the criteria and is evaluated

essentially the same in appearance, quality, and ease of servicing requirements, it may be added to these specifications at the Director's discretion.

5-8. STREET LIGHT DESIGN DETAILS

Design details for street lights shall conform to appropriate Standard Drawings and as follows:

- A. Intersections – Intersections shall have at least one street light
- B. Cul-de-sacs – All cul-de-sacs shall have a street light within the bulb unless a photometric plan demonstrates it is not necessary to meet illumination .
- C. Pedestrian Lanes – Street lights shall be placed at both ends of pedestrian lanes.
- D. Spacing – Maximum street light spacing, measured along the street centerline, shall conform to Standard drawings, except on arterial and thoroughfare streets with a 1,000-foot or smaller radius horizontal curve, in which case the maximum spacing is 170 feet. Note that light spacing for 84-foot, 108-foot, and 130-foot streets, the spacing dimension is based on one-side of the street and two lights are placed at each longitudinal location (either with poles on opposite sides of the street or tandem poles in the median). Spacing on all other streets is based on a staggered arrangement, and is measured between poles on alternating sides of the street. Maximum spacing may be adjusted as long as illumination criteria are shown to be satisfied on a photometric plan and any additional supporting data, with approval of the - Director.
- E. Street Light Poles – All street light poles shall be of galvanized steel except as provided for by Item F below. All pole construction and materials shall conform to the standards outlined in the Standard Construction Specifications, Section 49-2.04, "Standards, Steel Pedestals and Posts", and the Standard Drawings referenced therein. Pole materials shall be identified on the plans or in the special provisions.

Identification numbers are assigned by the City at acceptance of the improvement plans. The identification number of each pole shall be labeled on the pole prior to construction acceptance by the City. Labels shall be 2" letters and/or numbers and shall be applied vertically on the pole from top to bottom. The bottom of the lowest letter and/or number shall be ten feet (10') above the ground surface. Pole identification numbers shall face 45 degrees to oncoming motor vehicle traffic..

- F. Street Lights on Existing Utility-Owned Poles – Where there are permanent existing (or necessary planned) utility-owned poles adjacent to the roadway, the street lights may be installed upon the utility pole in lieu of the poles required on an exception basis if approved by the Director. Should the utility pole option be requested and authorized, the following shall apply:

1. In the Sacramento Municipal Utility District (SMUD) service area, the Applicant shall arrange to install City-owned/utility-maintained street lights on existing utility poles in accordance with SMUD Rate SL CODM.
 2. Spacing of lights shall be varied to meet locations of existing utility poles, but shall not exceed the maximum spacing specified by Standard drawings. Street light mounting heights shall be as shown on the Standard drawings. All luminaries shall have wattages relating to the street classification requirements shown on Standard drawings.
- G. Luminaires - All street lighting luminaires shall be light emitting diodes (LED) unless otherwise directed by the City. The type of street light and the appropriate wattage shall be specified on the plans. All luminaries shall conform to the standards outlined in the Standard Construction Specifications, Section 49-6.01, "Light emitting Diode (LED) Luminaires". Light distribution shall be American national Standards Institute (ANSI) Type III, unless otherwise specified by the City, and luminaries shall be cut off-type unless specified otherwise by the Director.
- H. Service - All street light systems shall have underground service provided through a utility company approved metered service pedestal. Service voltage shall be shown on the plans. Service voltage shall be 120 volts, except service voltage may be 277 volts when 120 volt service is not available. A step-down transformer shall be provided when service voltage is not 120 volts. Service points shall be provided within a Public Utility Easement immediately adjacent to the right-of-way, or within the right-of-way, and at a point which is as reasonably near as possible to the serving utility power source.
- I. Pull-boxes - All pull-boxes, including the size, shall be shown and identified on the plans. Pull-boxes shall be installed at all locations where more than two conduit runs intersect, where conduit runs are more than 250 feet long, where shown on City Standard Drawings, at critical angle points, at property lines at the end of the required conduit run to the property line (see Section 5-8 L, "Conduit"), behind each light when No. 4 A.W. G. conductors are used, and at such locations ordered by the Director. Normally a No. 3-1/2 pull-box will be allowed when three or fewer conduits of 1-1/4" or smaller size are involved or at the end of the required conduit run to the property line (See Section 5-8 L, "Conduit").
- J. Conductors - All conductors, including quantity and size, shall be identified on the plans. Unless otherwise specified, conductors shall be single conductor, solid or stranded copper, sized in accordance with these standards and the National Electrical Code.

The minimum conductor size from the service point to the service enclosure shall be No. 8 A.W.G. The size of each conductor from the service enclosure to the luminaries shall be such that the voltage drop along each circuit will not exceed 7% for 2-wire and 6% for 3-wire systems of the service voltage to the farthest luminaire. The service voltage to be used is 120 volts. Calculations shall be submitted substantiating the design criteria for every circuit. Calculations shall

also be submitted showing the total load in amperes of each circuit at the service enclosure.

- K. Photo Cell – All street lights must be controlled by a photo cell. Multiple street lights may be controlled by a single photo cell receptacle provided on the nearest suitable luminaire to the service enclosure for multiple service systems.
- L. Conduit – All conduit runs, including the size, shall be shown and identified on the plans. The conduit size shall be determined using Standard drawings SL-15 as a guideline, with the minimum size being 1-1/2” diameter conduit.
 - 1. The design may include more than two circuits in a conduit if the conductors for each circuit (2-wire) or set of circuits (3-wire) are identified by conductor insulation which is a solid color or a basic color with a permanent colored strip. The identification strip shall be continuous over the entire length of the conductor.
 - 2. New development shall install 2” minimum diameter conduit, or larger as required, with one No. 10 A.W.G. stranded pull-wire from the last light on each end of the system to the adjacent property line, where the adjacent property has no existing street lighting system.
- M. Electrical Equipment and Work – Control and switching equipment and fusing of all circuits shall meet the requirements of the National Electrical Code, the Basic Electrical Regulations, Title 24, Part 3, of the California Administrative Code, the rules of the National Board of Fire Underwriters, and the City of Elk Grove.

5-9. LAYOUT PLANNING

Layout planning is the determination of street light locations between control points. Control points are proposed street light locations at street intersections in accordance with Section 5-8, and appropriate Standard drawings; and existing street lights. The purpose of layout planning is to establish an overall uniform street light system meeting minimum requirements. On 84-foot, 108-foot, and 130-foot streets, spacing dimensions resulting from layout planning shall apply to distances between street lights on one side of the street. On all other streets, layout planning dimensions shall apply to both sides of the street. The procedure for layout planning is outlined as follows:

- A. Identify the nearest intersections each way from the street light locations being planned. Determine the location of the street lights at the intersections in conformance with the design standards in Section 5-8 above.
- B. Identify any existing street lights situated between the intersections.
- C. Determine the distance between the adjacent designed intersection street lights and/or adjacent existing street lights, whichever are nearest to the street light locations being planned.
- D. Divide the distance into equal spaces between lights not to exceed the maximum spacing requirements specified in Section 5-8 above.

- E. Compare the light locations to intersecting property lines, driveways, pedestrian lanes, and other obstructions as follows:
 - 1. If the location falls close to a property line and it can be adjusted to the property line while staying within the maximum spacing allowed, then the adjustment shall be made.
 - 2. Generally, street lights shall be situated at intersecting property lines for residential lots and parcels with minimal frontage (75 feet or less). The light spacing may have to be unbalanced, with additional lights being added to attain this and still comply with the maximum spacing allowed.
 - 3. Street light locations shall be adjusted to miss driveways, existing utility poles, trees, tree wells, and other obstructions by at least five feet.

- F. Street light locations on streets wider than 80 feet shall be adjusted, when possible, to obtain a more uniform light distribution if there are existing street lights on the opposite side of the street in accordance with Section 5-8 D.

SECTION 6

SOUND BARRIER DESIGN

6-1. LOCATION REQUIREMENTS

Sound barriers may be required along the rear and side property lines of residential developments adjacent to freeways, major highways and other ground level noise elements in order to achieve the noise objectives of the City of Elk Grove Noise Element, Noise Ordinance, or as required by the project conditions of approval. If the residential development abuts a City-owned landscape corridor or public right-of-way, the entire sound barrier, including footings, shall be located on the publicly owned side of the property line, unless otherwise required by a condition of development. In cases where the City does not own or control the adjoining property, the sound barrier shall be located on the residential development side of the property line.

6-2. DESIGN

The sound barrier shall be designed to obtain a 60 LDN at the affected property line or as required by the Director. There are existing soundwall systems that have been approved by the City. Information on the systems is available through the Director.

The Director may approve new sound barriers upon request. The request shall include plan details and calculations prepared and signed by an appropriate Consulting Engineer.

Sound barriers shall be designed for a minimum longevity of 30 years.

Sound barriers constructed along freeways, or at the back of sidewalk along the outside of curved major streets, shall incorporate a vehicular barrier-type design element to minimize the potential for vehicles penetrating the wall. Other locations that represent a higher potential for run-off-road accidents shall be required to incorporate a Caltrans Type 50 (or equivalent) barrier-type design element.

Open cells in hollow-type sound barriers shall be grouted on post-tensioned wall systems as required by the Director.

6-3. PLAN REQUIREMENTS

All construction details for sound barriers, including the locations and limits, shall be shown on the site improvement plans.

6-4. MAINTENANCE FUNDING

For all sound barriers to be located within a City owned parcel and/or public right-of-way, the Applicant shall provide a list of quantities and descriptions of the sound barrier and any accessory improvements to be maintained by the City. This information will be used by the City to determine the appropriate maintenance funding mechanism (i.e. – tax zone allocation within a special tax district) that may be applied to the project. No sound barriers shall be accepted by the City for maintenance until an appropriate funding mechanism has been established to the satisfaction of the Director. The funding mechanism shall include an annual escalator, such as the CPI.

SECTION 7

TRAFFIC IMPACT ANALYSIS GUIDELINES

7-1. INTRODUCTION

Traffic Impact Analysis Guidelines shall conform to the requirements set forth in the City of Elk Grove's General Plan or most recent General Plan Update.

SECTION 8

RESERVED FOR FUTURE USE

SECTION 9

STORM DRAINAGE DESIGN

9-1. CITY POLICY AND REQUIREMENTS

- A. The planning, design and construction of drainage facilities and other related appurtenances to be owned, operated and maintained by the City of Elk Grove shall comply with these standards herein referred to as the “Standards”.
- B. These design and construction standards are intended to provide minimum standards for design, construction and repair of all drainage facilities/infrastructure within the City of Elk Grove.
- C. Designs shall be consistent with City plans including the General Plan, specific plans, master plans, and capital improvement plans/programs. Specific requirements for the improvement and construction of drainage facilities are set forth, in order of precedence, in the following documents:
 - City of Elk Grove Municipal Codes
 - City of Elk Grove Floodplain Management Policies
 - City of Elk Grove Improvement Standards (this document)
 - City of Elk Grove Standard Construction Specifications
- D. The storm drainage system design shall be based on a drainage study that describes the improvements necessary to mitigate any adverse impacts of changed runoff caused by the project. The design of a new storm drain system shall include consideration of the downstream creek or storm drain. The consulting engineer shall show that the existing storm water system can convey the proposed drainage without adverse flooding, erosion or other water quality impacts to upstream, downstream or adjacent facilities or areas; or that such facilities or areas are being improved or protected to the point where the drainage can be conveyed without adverse impacts. Improvements shall not cause a net loss of storage, nor an increase in velocity, of drainage water within the 100-year floodplain.
- E. All submitted studies, plans, and calculations shall be signed and stamped by a Registered Civil Engineer prior to approval and all work shall be in accordance with these design standards and good engineering practice.
- F. The Director shall decide all questions of interpretation of “good engineering practice,” guided by the standards and manuals of the discipline in question.
- G. All public drainage facilities shall be located within the City’s right-of-way, within a parcel owned by the City (fee title parcel), or within an easement, unless otherwise approved by the Director. Adequate right-of-way and/or easements shall be required to provide access for installing, repairing, maintaining, improving, operating, constructing, and reconstructing of drainage facilities. Any area designated for public drainage facilities, including overland flow conveyance routes, not confined to existing public right-of-ways shall be dedicated as a fee title parcel to

the City. In certain cases, the Director may approve alternate forms of dedication. The City will not accept any conservation or other conditional easement on drainage courses to be conveyed to the City.

- H. Areas defined by FEMA as 100-year floodplain limit shall be dedicated to the City as a floodway/floodplain easement.
- I. All new structures shall be protected from the 100-year (1 %) flood event. Certified pad elevations, per Section 10-8 of these Standards, must be submitted with the application for building permit, if not already on file with the City. All finished floor elevations shall be set at least one and one-half feet (1.5') above all sources of 100-yr flooding, unless otherwise required pursuant to Elk Grove's Municipal Code. If the elevation of the 100-year (1%) flood event is not available, it must be calculated by a Registered Civil Engineer, to the satisfaction of the Director.
- J. Prior to approval of improvement plans for projects that impact protected environmental resources, the applicant shall provide copies of all permits required by outside regulatory agencies.
- K. Private storm drain systems shall be clearly noted on the plans and maintenance responsibilities shall be described in a document recorded on the property.
- L. Storm water quality treatment facilities shall be provided for new and redevelopment projects in accordance with Section 11 of these Standards.

9-2. STORMWATER UTILITY

The City maintains public drainage facilities within the City of Elk Grove Storm Water Utility service area. Prior to issuance of building permit, each building and parcel within the City will become part of the Stormwater Utility.

9-3. DEFINITIONS

The following terms, abbreviations or definitions shall apply and the intent and meaning shall be interpreted as stated herein wherever they are encountered in these Standards or in any documents or instruments referenced by these standards unless otherwise approved by the Director.

- ASTMAmerican Society for Testing and Materials.
- Base Flood.....100-year (1% annually) flood event pursuant to the City of Elk Grove Floodplain Management ordinance or any source of 100-year flooding as determined by Public Works.
- Certified Pad ElevationAs defined in the Grading Section of these Standards
- DirectorDirector of Public Works of the City of Elk Grove or his/her designee.

CLOMA/LOMA.....	Conditional Letter of Map Amendment/ Letter of Map Amendment.
CLOMR/LOMR.....	Conditional Letter of Map Revision/ Letter of Map Revision.
County	The unincorporated County of Sacramento
Design Storm	The design runoff
Drainage Easement.....	A strip of land dedicated, condemned or reserved for drainage use.
Drainage Manual.....	The Sacramento City/County Drainage Manual consisting of five volumes dated December 1996 as revised or updated. Volume 2 contains the Hydrology Standards with graphs and charts cited in these standards.
Freeboard.....	The vertical distance from the design feature (top of a channel or bottom of bridge, etc.) to the water surface elevation at the design condition.
Federal Flood Zone.....	An area at risk of flooding as determined by the FEMA Flood Insurance Rate Maps
FIRM.....	Flood Insurance Rate Map
FEMA	Federal Emergency Management Agency.
Interim Facility	A temporary facility that is constructed and maintained by the Applicant or their designee.
Local Flood Zone.....	An area possessing a flood risk in the base flood, not defined on the FEMA FIRMs.
NFIP.....	National Flood Insurance Program.
One Hundred-Year Storm.....	A hydrograph created using the Sacramento Method indicating runoff over time for a storm with a one-percent statistical probability of annual recurrence.
Overland Release Path	An alignment that allows the passage of floodwater through a development without damaging structures.
Reimbursement Agreement.....	An agreement between the City of Elk Grove and Applicant identifying eligible reimbursement costs.
Right-of-Way.....	A strip of land dedicated, condemned or reserved
SCDWR.....	Sacramento County Department of Water Resources.
SCWA.....	Sacramento County Water Agency, a political subdivision of the State of California

Specifications.....	City of Elk Grove Standard Construction Specifications, latest version.
Standards	These storm drain design standards.
Ten-Year Storm	A hydrograph created using the Sacramento Method indicating runoff over time for a storm with a ten-percent statistical probability of annual recurrence.
Trunk Drainage	Mainline drainage from an area 30.00 acres or greater.
Volume 2.....	Volume 2, <i>Hydrology Standards</i> , of the Sacramento City/County Drainage Manual.

9-4. FEDERAL EMERGENCY MANAGEMENT AGENCY (FEMA) FLOOD PROGRAM

- A. The City of Elk Grove is a participant in the National Flood Insurance Program and all development in the City shall comply with the regulations of the Federal Emergency Management Agency (FEMA) and the City’s Floodplain Management ordinance. Amendments or revisions of FEMA flood maps shall be required for all development located in a Special Flood Hazard Area. Petitions for a Conditional Letter of Map Amendment (CLOMA) or Conditional Letter of Map Revision (CLOMR) shall be submitted to Public Works and FEMA and approved by both entities before improvement plan approval. Any required fees shall be paid directly to FEMA by the applicant.
- B. Petitions for a Letter of Map Amendment (LOMA) or Letter of Map Revision (LOMR), including any fee required by FEMA, shall be submitted and approved by Public Works and FEMA before building permit issuance.
- C. Fill for the removal of land from the FEMA 100-year floodplain of a watercourse, where building pads will be created, must comply with the FEMA standards.
- D. These regulations do not preclude the City from requiring additional standards to protect the public from projected flood runoff.

9-5. DRAINAGE FEES AND CREDITS

All developments in the City are subject to payment of a drainage impact fee based on the Drainage Capital Improvement Plan. Reimbursement agreements, if applicable, with the City/County shall be signed by the Applicant, and notarized, before approval of improvement plans.

9-6. IMPACTS TO EXISTING DRAINAGE

All drainage must enter and leave the project area at its existing line and grade, unless otherwise approved by the Director. Concentration of flows on adjacent properties is not allowed without appropriate mitigation, including but not limited to:

- 1. Energy dissipation.

2. Erosion control.
3. Acquisition of offsite easements and construction of offsite drainage facilities.

No net increase of peak flows is allowed. And no net adverse impact for volume, quality or duration is allowed. All impacts must be mitigated in the project area or lands acquired for mitigation by the project.

9-7. LOCATION OF FACILITIES AND LAND DEDICATIONS

- A. All storm drain facilities must be in the road right-of-way or parcel owned by the City in fee. Such parcels must be a minimum of 25 feet wide, and sufficiently wide to accommodate normal construction equipment, and shall be easily accessible to such equipment as necessary to construct, operate, maintain and reconstruct the facility. These parcels shall be dedicated to the City of Elk Grove, and such parcels shall not split along property lines.
- B. Where improvements outfall onto an adjacent property (such as day-lighting ditch profiles) dedication in fee to the City is required.
- C. In the event necessary permanent offsite parcels or easements cannot be acquired through negotiation, the Applicant may request that the City consider condemning necessary rights-of-way. The person, firm, or corporation requesting such condemnation shall be required to enter into a written agreement to pay all costs and expenses of the condemnation.
- D. Acquisition and maintenance of temporary construction easements outside of the limits of the subdivision shall be the sub-divider's responsibility.
- E. Drainage parcels, right-of-ways, or easements (if authorized) for drainage facilities, shall meet the following criteria:
 1. Minimum width of the parcel/right-of-way shall be twenty-five feet (25').

For closed conduits, dedications shall have a minimum width equal to the greater of twenty-five feet (25') or the required trench width plus two feet (2') of additional width for every foot of depth as measured from the bottom of the pipe to finished grade with accommodation of a minimum set back distance from the conduit to the edge of the parcel/right-of-way of ten feet (10').

2. Parcels or drainage easements for open channels shall have sufficient width to contain the ultimate channel; as well as, fencing and a twenty-foot (20') service road. Additional width shall be provided to allow equipment to safely negotiate the service road for the purposes of construction, operations and maintenance activities. Exceptions may be made on a case-by-case basis depending on the layout of adjoining roadways and recreational paths, with approval from the Director. See also Section 9-22 "Site Requirements" of these Standards.

9-8. DRAINAGE DESIGN CAPACITY

- A. All drainage systems (including open channel roadside ditches) shall be designed to accommodate all planned development of the entire upstream watershed. Closed conduit systems shall be designed to accommodate the appropriate design storm event flows as determined using the methods prescribed in Section 9-10.
- B. All other open channel drainage systems shall be designed to carry the 100-year frequency design storm, using the worst case duration and providing for at least 1 foot of freeboard.

9-9. DESIGN SUBMITTALS

- A. A reconnaissance level or suitability level drainage study may have been required and prepared as part of a development application. As part of the design of a drainage system, a comprehensive drainage study must be prepared for review and acceptance by the City. The comprehensive drainage study shall include but is not limited to: definition with mapping of the existing watersheds; a detailed pre- and post-project hydrologic and hydraulic analysis of the project and project impacts; definition of the local controlling 100-year frequency water levels existing and with project; and the proposed method of flow conveyance with adequate supporting calculations. The study shall include any proposed improvements to mitigate the impacts of increased runoff from the project and any change in runoff including quality, quantity, volume, and duration. The study shall incorporate the City of Elk Grove Drainage Capital Improvement Plan; be consistent with the ultimate upstream development in the General Plan and any specific, area, or master plans; and shall conform to the City of Elk Grove Improvement Standards. It shall demonstrate that the proposed methods of flow conveyance mitigate the potential project impacts. The study shall further demonstrate that the lots on the proposed Final Map shall be outside the 100-year frequency floodplain after improvements are constructed in accordance with the policies in the City Flood Drainage Prevention Ordinance (Ordinance 14-2017). The Study must be completed and stamped by a Professional Engineer, and determined by the City to be comprehensive, accurate, and adequate.
- B. The drainage study submitted shall include, as a minimum, the following information and computations:
 - Report cover with address, APN, control number and name of project as contained in planning documents.
 - Purpose, objectives, and established criteria for project study.
 - Table of contents and List of Appendices and Figures.
 - Topographic map showing existing and proposed ground elevations.
 - Existing conditions, hydraulic features, environmental constraints, and easements.
 - Hydrologic and hydraulic methods utilized in the modeling.
 - Electronic copy of modeling files (if applicable),

- A shed map including on-site and off-site watershed boundaries draining onto the site. It shall also include land uses, total and sub-shed areas in acres, plus proposed and existing pipe network nodes labeled as they are in the electronic model.
- Quantity of flow (cfs) to each drainage inlet structure with corresponding area and land uses that generates the quantity.
- Quantity of flow (cfs) in each pipe.
- Flow line elevation of each manhole or junction structure.
- Top of structure rim elevation.
- Location of downstream outlet and hydraulic grade line at this location.
- Hydraulic grade line of the systems.
- Pipe size, material type, class, length and slope.
- Channel dimensions, flow and water surface profile computations.
- Overland Release hydraulic computations for street and non-street releases.
- Analysis of permits required including type, processing time, and expected restrictions.

The applicant shall obtain applicable California Department of Fish and Wildlife, U.S. Army Corps of Engineers, and other required state and federal permits. The conditions of such permits must be reviewed and conditions considered acceptable by the City, before the permit is issued.

C. Improvement Plans must contain the additional features

- Pipelines plans and profiles with hydraulic grade line information
- Open channel plans and profiles
- Phasing plans if all improvements are not constructed in the same time
- An overflow release map showing surface elevations and flow paths
- Notes concerning agreements and dedications

9-10. DESIGN RUNOFF

The required design methods, their appropriate applications, and design tools are summarized in Table 9-1. Use of design methods for runoff calculations in the City of Elk Grove is described in Volume 2 Hydrology Standards of the City/County Drainage Manual. Other design tools, including hydrodynamic model and analysis software (e.g. XPSWMM), may be used subject to approval of the City. SACCALC is a Windows based software, available for free download, for assistance with these calculations. Design criteria concerning the approach for new and infill projects are summarized in Table 9-1A.

A. In drainage areas that contain multiple zoning, the runoff shall be computed from the following formula:

i. $Q_{\text{Design}} = Q_r + (Q_m - Q_r) A_m/A_t + (Q_c - Q_r) A_c/A_t$

- ii. Where: Q_r =Flow from residential curve using total area of watershed.
 Q_m =Flow from multiple family formula using total area of watershed.
 Q_c =Flow from commercial curve using total area of watershed.
 A_m =Area of multiple family zoning.
 A_c =Area of commercial zoning.
 A_t =Area in total.

B. At sag points where the total change in grade exceeds 4% within 200 feet of a drop inlet, the design Q at that inlet shall be increased to 0.7 cfs/acre. The runoff to be used in drainage channel and channel/bridge design for watersheds exceeding the capacity of a 72" pipe, typically over 160 acres, shall be determined using the Sacramento Method, Volume 2 Hydrology Standards.

Table 9-1 Minimum Design Runoff Flows			
Application	Hydrology Calculation	Method	Design Tools
Design of street drainage, storm sewers, and culverts (driveway)	Flow from Charts	Nolte	Design Charts (SD-1A to SD 1C)
*Special Design Case for street drainage, storm sewers and culverts	Peak Flow for 100-year Volume	Sacramento	Design Charts, HEC-1 and SACCALC
Design of overland release, culverts, and bridges**	Peak Flow for 100-year Volume	Sacramento	Design Charts, HEC-1 and SACCALC

* Special design cases include: streets designated for emergency evacuation, high use public areas, areas with potential loss of life, areas with potential high property damages, areas with limited overland release, and areas lower than surrounding elevations

** Overland release flows may be determined from Figures 2-11 and 2-18 thru 2-23 of the Volume 2 Hydrology Standards for shed areas less than 160 acres.

Table 9-1A Design Criteria by Project Type			
Condition	Hydrologic Calculation	Design HGL	Constraints
New Projects including Connecting and Infill Projects	Nolte Method Zone 2	For 10-year, 6 inches below gutter flow line at Drainage Inlet	Finished floor of any building shall be at least 1.5 feet above 100-year water level

Computation of runoff shall be performed in the appropriate manner prescribed below.

Use the Sacramento Nolte Method as outlined on City of Elk Grove hydrologic design criteria is described in Volume 2, Hydrology Standards, of the City/County Drainage Manual. Elk Grove is in the Zone 2 Rainfall Zone for the Sacramento Nolte Method. SACCALC is a Windows based software, available for free download, for assistance with these calculations.

9-11. HYDRAULICS

A. Hydraulic Grade Line

1. Hydraulic grade line calculations for pipe storm drain systems shall begin at the worst case existing ultimate 10-year channel or basin water surface elevation. For the design storm, the hydraulic grade line shall be a minimum one-half foot (0.5') below the elevation of all inlet grates, or curb opening flow lines and a minimum one foot (1') below the elevation of manhole cover. The hydraulic grade line must be checked for the 100-year channel or basin water surface elevation, in order to determine the extent of flooding and the 100-yr water surface elevation throughout the area served by the basin.
2. The hydraulic grade line shall be shown on the plans.
3. For open channel systems, the hydraulic grade line shall be shown for the 10-year and 100-year storm events. In adjacent unimproved areas with no current development plans, the future gutter flow line is assumed one and one-half feet (1.5') lower than the natural ground elevation, for purposes of pipe hydraulics calculations. This also applies to in-fill development, where the elevation of the hydraulic grade line is not known.
4. In order to analyze the drainage system to determine if design flows can be accommodated without causing flooding at some locations or causing flows to exit the system at locations where this is unacceptable, the consulting engineer shall analyze the hydraulic gradient. A water surface profile calculation must be performed by the Consulting Engineer for the entire system. The starting

elevation for all hydraulic grade line calculations must be clearly noted on all plans and calculations. The source of this elevation must also be indicated (Master Plan, FEMA, etc.). If it is not readily available it must be calculated. If it is assumed, the basis of the assumption must be noted.

B. Friction Losses

Friction losses can be calculated two ways. These methods cannot be interchanged for design of the pipe system. One method shall be used throughout the analysis. The first method uses a conservative Manning's "n" value to account for minor losses.

1. Method 1

A water surface profile calculation must be performed by the Consulting Engineer for all open channels, closed conduits and culverts.

The minimum 'n' values to be used in the Manning's formula shall conform to the following:

Precast Concrete Pipe	0.015
High Density Polyethylene Pipe	0.015
Polyvinylchloride Pipe	0.015
Concrete Box Culvert (within a closed conduit system)	0.016
Ribbed Metal Pipe	0.015
Concrete Cast-In-Place Pipe	0.015
Pavement Surfaces	0.016
Open Channel Fully Lined	0.018
Corrugated Metal Pipe 2-2/3" x 1/2" Corrugations	0.024
Corrugated Metal Pipe 3" x 1" or 5" x 1" Corrugations	0.028
Open Channel with Lined Bottom, Clean Sides	0.035
Earth Channel with Clean and Uniform Sides	0.060
Earth Channel with natural bottom and sides	0.080

Using Method 1 does not require the analysis of other minor losses. Pipes and culverts that are designed with inlet control shall account for losses associated with inlet control.

2. Method 2 – Minor Losses

Calculation of minor losses more accurately models the system. Energy losses from pipe friction shall be determined by the following:

$$S_f = [Qn/1.486 AR^{2/3}]^2$$

Where: S_f = friction slope, ft/ft
Q = flow rate, ft³/s
n = Manning's coefficient
A = area, ft²
R = hydraulic radius

The head loss due to friction is determined by the formula:

$$H_f = S_f L$$

Where: H_f = friction head loss, ft
 L = length of outflow pipe, ft

The minimum “n” value used in Manning’s formula shall conform to the following:

Precast Concrete Pipe	0.012
High Density Polyethylene Pipe	0.012
Polyvinylchloride Pipe	0.012
Concrete Box Culvert (within a closed conduit system)	0.013
Ribbed Metal Pipe	0.013
Concrete Cast-In-Place Pipe	0.014
Pavement Surfaces	0.016
Open Channel Fully Lined	0.018
Corrugated Metal Pipe 2-2/3” x 1/2” Corrugations	0.024
Corrugated Metal Pipe 3” x 1” or 5” x 1” Corrugations	0.028
Open Channel with Lined Bottom, Clean Sides	0.035
Earth Channel (Clean, Uniform Sides) or Natural Channel	0.060
Earth Channel with natural bottom and sides	0.080

D. Velocity Head Losses

Analysis methods must account for all minor losses.

Minor head loss is usually written as:

$$H_L = K_c (V^2/2g)$$

Where: H_L is the minor head loss
 K_c is the sum of minor loss coefficients
 $V^2/2g$ is the velocity head

The loss coefficient and the form of the equation are different depending on the type of loss, whether flow is open channel or pressure flow, and at times, whether flow is sub-critical or supercritical. Full discussion and values of coefficients are given in several references (*Chow Open Channel Hydraulics*; Brater and King *Handbook of Hydraulics*; Rouse *Fluid Mechanics for Hydraulic Engineers*; Hendrickson *Hydraulics of Culverts*). The following are minor head loss formulas for hydraulic structures commonly found in storm drain systems and open channels.

E. Entrance Losses

Entrance losses to box culverts and pipes of various materials can be estimated by using the entrance loss coefficients listed in Table 9-3 in conjunction with the minor head loss equation, once outlet control has been established.

F. Manhole and Junction Losses

Junctions are locations where two or more pipes join together to form another pipe or channel.

Multiple pipes or channels coming together at a junction shall flow together smoothly to avoid high head losses. Items that promote turbulent flow and high losses include a large angle between the two (>60°), a large vertical difference between the two (greater than 6 inches (6") between the two inverts), and absence of a semicircular channel or benching at the bottom of the junction box in the case of pipes. Special problems arise when smaller pipes join a larger one at a junction.

1. Straight Through Manhole

In a straight through manhole where there is no change in pipe size, the minor loss shall be calculated by:

$$H_m = 0.05 (V^2/2g)$$

2. Incoming Opposing Flows

Design of opposing flows or 90 degree angles must be avoided. The head loss at a junction, H_{j1} , for two almost equal and opposing flows meeting head-on with the outlet direction perpendicular to both incoming directions is considered as the total velocity head of outgoing flow.

$$H_{j1} = V^2/2g$$

3. Changes in Direction of Flow

When main storm drainpipes or lateral lines meet in a junction, velocity is reduced within the chamber and specific head increases to develop the velocity needed in the outlet pipe. As a bend becomes sharper (approaching 90°), the more severe the energy loss becomes. When the outlet conduit is sized, determine the velocity and compute head loss in the chamber by the minor head loss formula in conjunction with the following:

<u>K</u>	<u>Degree of Turn (In Junction)</u>
0.19	15
0.35	30
0.47	45
0.56	60
0.64	75
0.70	90 and greater

Any degree of turn greater than 90 degrees requires the approval of the Director.

For a graphic solution to other degree of turns, refer to drawing SD-5. For culverts the Consulting Engineer must determine if the culvert works with inlet or outlet control for the peak flow of the given design frequency.

**Table 9-3
Entrance Loss Coefficients for Culverts (HDS 5 – latest edition) Outlet
Control, Full or Partly Full Entrance Head Loss.**

$$H_e = k_e (V^2/2g)$$

Type of Structure and Design of Entrance	Coefficient k_e
<u>Pipe Concrete</u>	
Projecting from fill, socket end (groove-end)	0.2
Projecting from fill, sq. cut end	0.5
Headwall or headwall and wing walls	
• Socket end of pipe (groove-end)	0.2
• Square Edge	0.5
• Rounded (radius = 1/12D)	0.2
• Mitered to conform to fill slope	0.7
• *End-section conforming to fill slope	0.5
• Beveled edges, 33.78 or 458	0.2
Bevels--Side- or slope-tapered inlet	0.2
<u>Pipe, or Pipe-Arch, Corrugated Metal</u>	
Projecting from fill (no headwall)	0.9
Headwall or headwall and wing walls square-edge	0.5
Mitered to conform to fill slope, paved or unpaved slope	0.7
*End-section conforming to fill slope	0.5
Beveled edges, 33.78 or 458 bevels	0.2
Bevels--Side- or slope-tapered inlet	0.2
<u>Box, Reinforced Concrete</u>	
Headwall parallel to embankment (no wing walls)	
• Square-edged on 3 edges	0.5
• Rounded on 3 edges to radius of 1/12 barrel dimension, or beveled edges on 3 sides	0.2
Wing walls at 308 to 758 to barrel	
• Square-edged at crown	0.4
• Crown edge rounded to radius of 1/2 barrel dimension, or beveled top edge.	0.2
Wing walls at 108 to 258 to barrel	
• Square-edged at crown	0.5
Wing walls parallel (extension of sides)	
• Square-edged at crown	0.7
• Side - or slope-tapered inlet	0.2

*Note: "End-section conforming to fill slope," made of either metal, concrete or HDPE are the sections commonly available from manufacturers. From limited hydraulic tests they are equivalent in operation to a headwall in both *inlet* and *outlet* control. Some end sections, incorporating a *closed* taper in their design, have a superior hydraulic performance.

HDS -5 (U.S. DOT "Hydraulic Design of Highway Culverts Series No. 5, Latest edition)

The following equation may be used to determine the loss in head in cases where it may be necessary to split or branch the flow into another drain.

Figure 9-1

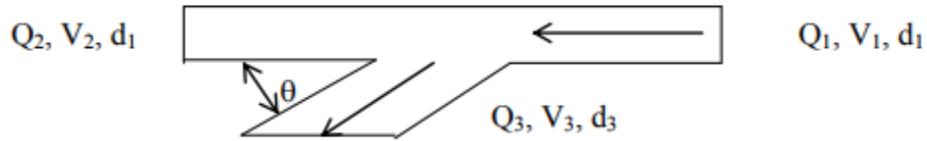

$$H_{br} = cV_1^2/2g$$

Divergence Angle - θ	$Q_3/Q_1 = 0.3$	$Q_3/Q_1 = 0.5$	$Q_3/Q_1 = 0.7$
90°	$c = 0.76$	0.74	0.80
60°	$c = 0.59$	0.54	0.52
45°	$c = 0.35$	0.32	0.30

4. Several Entering Flows

The computation of losses in a junction with several entering flows utilizes the principle of conservation of energy, involving both position energy (elevation of water surface) and momentum energy (mass times velocity head). Thus, for a junction with several entering flows, the energy content of the inflows is equal to the energy content of the outflows plus additional energy required by the collision and turbulence of flows passing through the junction. In addition, when two nearly equal flows enter the junction from opposing directions, head loss is considered as the total velocity head of the outgoing flow.

For example, the total junction losses at the sketched intersection are as follows (Figure 9-2):

Figure 9-2

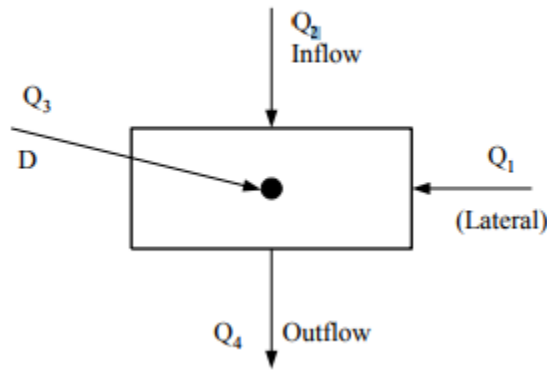

$$H_{j2} = [(Q_4 V_4^2) - (Q_1 V_1^2) - (Q_2 V_2^2) + (K Q_1 V_1^2)] / (2g Q_4)$$

Where: H_{j2} = junction losses, ft
 Q = discharges, cfs
 V = horizontal velocities ft/s
 V_3 = is assumed to be zero
 K = bend loss factor

Subscript nomenclature for the equation is as follows:

Q_1 = 90 ° lateral, cfs
 Q_2 = straight through inflow, cfs
 Q_3 = vertical dropped-in flow, from an inlet, cfs
 Q_4 = main outfall = total computed discharge, cfs
 V_1, V_2, V_3, V_4 are the horizontal velocities of foregoing flows, respectively in feet per second

Also assume:

$$H_b = K (V^2)/2g \text{ for change in direction.}$$

No velocity head of an incoming line is greater than the velocity head of the outgoing line.

Water surface of inflow and outflow pipes in junction to be level.

When losses are computed for any junction condition for the same or a lesser number of inflows, the above equation shall be used with zero quantities for those conditions not present. If more directions or quantities are at the junction, additional terms shall be inserted with consideration given to the relative magnitudes of flow and the coefficient of velocity head for directions other than straight through.

G. Bend Loss

Bend losses shall be calculated from the following equations:

$$H_b = K_b (V^2/2g)$$

In which: $K_b = 0.20 (\Delta/90^\circ)^{0.5}$

Where: Δ = Central angle of bend in degrees.

Bend losses shall be included for all closed conduits, those flowing partially full as well as those flowing full.

H. Trash-Rack Head Loss

The head loss through a stationary trash-rack is commonly determined from the following equation:

$$H_{TR} = K_{TR} (V_n^2/2g)$$

$$K_{TR} = 1.45 - 0.45 A_n/A_g - (A_n/A_g)^2$$

Where: K_{TR} = Trash-rack coefficient

A_n = Net area through bars, in ft²

A_g = Gross area of trash-rack and supports (water area without trash-rack in place), in ft²

V_n = Average velocity through the rack openings (Q/A_n), in ft/sec

For design, assume that the rack is clogged, thereby reducing the value of A_n by 50%.

9-12. CLOSED CONDUITS

The specific type of pipe or alternate pipe to be used in the development shall be shown on the profile sheets. The minimum inside diameter for pipes used in the public right of way shall be no less than twelve inches (12"). No storm drain conduit shall have a diameter less than that of the conduit immediately upstream of it.

A. Material

Publicly maintained drainage systems shall be constructed of the following materials and installed consistent with the latest edition of City of Elk Grove's Standard Construction Specifications:

1. Reinforced Concrete Pipe

Class of pipe shall be based upon depth as detailed in the Standard Drawings. Pipe shall conform to ASTM C76, latest revision. The consultant shall specify on the plans that the assembly of joints shall be in accordance with the pipe manufacturer's recommendations and the requirements of ASTM C443.

2. Concrete Cast-In-Place-Pipe

a.) Where Concrete Cast-In-Place-Pipe is to be used, a soil report is required for the project that addresses placement of Concrete Cast-In-Place-Pipe.

- b.) The Consulting Engineer shall provide details on the plans for connection of the concrete cast-in-place-pipe to the different piping materials being used.

3. Polyvinyl Chloride Pipe

Polyvinyl Chloride (PVC) Pipe may be used conforming to the Construction Specifications. Use of polyvinyl chloride downstream of the last manhole or junction structure to outfalls to channels or detention basins is not allowed.

4. High Density Polyethylene Pipe

- a) HDPE shall not be used in existing or future roadways or for driveway culverts. It may only be used for trunk lines outside roadways.
- b) Use of High Density Polyethylene Pipe downstream of the last manhole or junction structure to open channels, detention facilities or to a daylight condition is not allowed.

5. Metal Pipe

- a.) Metal pipe shall be corrugated steel, corrugated aluminum, corrugated aluminized steel Type II, ribbed steel, ribbed aluminized steel Type II or ribbed aluminum.
- b.) Metal pipe shall be designed for a minimum maintenance free service life of fifty (50) years in accordance with the methods specified in Section 854.3 and 854.4 of the California Department of Transportation Highway Design Manual. To assure that the service life is achieved, alternative metal pipe may require added thickness and/or protective coatings. The Consulting Engineer shall provide certified copies of the laboratory report giving the results of pH and resistivity tests. The report shall also include a map showing the location of each site and depth where samples were taken.
- c.) Unless otherwise specified by the Director, a minimum of two soil samples shall be taken for the first 1,000 lineal feet of pipe or fraction thereof on a project with a minimum of one additional sample being required for each additional 1,000 lineal feet of pipe or fraction thereof. The samples shall be taken along the approximate alignment and at the approximate depth of the pipe to be installed. Priority in sampling shall be given to trunk facilities.

B. Cover Requirements

At locations where the minimum cover requirements cannot feasibly be obtained, the conduit shall be provided with a concrete cover or other methods of pipe protection as approved by the Director. Cover shall be measured from the top of a rigid Portland cement concrete pavement or the bottom of a flexible asphalt concrete pavement structural section.

- 1. Minimum Cover - The minimum cover requirements shall be per Table 9-4 and measured from the top of pipe to top of subgrade (bottom of A.B.).

2. Maximum Cover - Maximum height of cover shall be per Tables 9-4a and b.

C. Temporary Construction Vehicle Loading

1. A note shall be made on the plans stating the minimum cover requirements during construction for temporary heavy construction vehicle loading, such as scraper or truck haul routes.
2. For flexible pipes, place at least four feet (4') of cover over the top of the pipe.
3. For rigid pipes, place at least three feet (3') of cover over the top of the pipe.

D. Trench Requirements

1. Trenches shall be excavated with full depth and vertical sides whenever possible.
2. The minimum trench width shall not be less than the outside diameter of the pipe barrel plus sixteen inches (16"), measured at the top of the pipe. Where conditions require side sloping of trenches, the minimum vertical trench shall be from the bottom of the trench to one foot (1') over the top of the pipe.
3. In fill areas, or in areas with poor soil conditions where it is anticipated that a good, firm, vertical-walled trench cannot be constructed, the consulting engineer shall design the pipe structural requirements in accordance with good engineering practice. A note shall be placed on the plans directing the contractor to place the proper strength pipe if trench conditions encountered differ from those stated in the design trench plans.

E. Spacing Requirements

When multiple adjacent pipe lines are used, they shall be spaced so that the sides of the pipes shall be no closer than two feet (2'). For parallel pipes larger than forty-eight inch (48") the spacing shall be no closer than one half (1/2) the nominal diameter. This is to permit adequate compaction of backfill material. Special bedding and backfill considerations shall be taken when depths of parallel pipes vary.

F. Alignment Requirements

1. The preferred location of storm drainage pipes in new streets shall be typically six feet (6') north or west of and parallel to the centerline of the street. In special situations, and if necessary to meet State required water separation standards, pipelines may be placed in alternative locations, including under curb and gutter, as approved by the Director.
2. All new storm drain mains shall be placed a minimum of one hundred feet (100') from existing and proposed water wells. Encroachments less than one hundred feet (100') require approval of Director and the water purveyor prior to plan approval.

3. Avoid unnecessary meandering and angular changes of pipelines. Angular changes, when necessary, shall not exceed 90 degrees unless approved by the Director. No angular changes in direction are allowed for concrete cast-in-place-pipe other than on a radius.
4. Pipeline Radius Criteria: All pipe placed on curves shall meet manufacturer's recommendations for curved alignment. All curves, radii, length of pipe joints, and types of pipe shall be shown on the plans. The minimum radius of curvature for concrete cast-in-place-pipe shall be determined by the formula $R = 30D$ where R = radius of curvature, and D = nominal internal pipe diameter, with R and D expressed in the same units.
5. Pipelines shall be laid straight in both horizontal and vertical planes between manholes unless otherwise approved by the Director.
6. Where storm drain pipelines of different diameter join, the invert elevations shall be adjusted to maintain a uniform energy gradient.

G. Velocity

1. The minimum full flow velocity shall be no less than two (2) feet per second. The maximum velocity, at maximum pipe system capacity, shall be less than the critical velocity.
2. For velocities larger than ten (10) ft/second, special provisions shall be taken to prevent pipe displacement, and/or manhole lid surcharge.

H. Pipe Inlets and Outlets

1. Headwalls, flared end section and other structures at inlets shall be designed to increase hydraulic efficiency, prevent erosion adjacent to the conduit and provide a counterweight to prevent flotation. Headwalls or flared end sections shall be used at both intake and discharge ends of culverts and pipes.
2. Standard headwalls shall be installed at pipe outlets per standard drawings of the latest edition of the Standard Construction Specifications.
3. The vertical face of the headwall shall be set back a sufficient distance from the channel side slope to accommodate flap-gates (when needed) in a fully opened position without encroachment of the flap past the channel side slope face.
4. All pipe and culvert entrance and outlet locations must be provided a concrete apron with a minimum length of five (5) pipe diameters for erosion control and maintenance purposes.
5. Pipe inlets greater than 24 inches shall have a trash rack installed. Pipe Outlets greater than 36 inches, not in an area enclosed with a fence, shall have a trash rack installed for access control.

6. Energy dissipators must be utilized at outlets at the end of the concrete apron. All energy dissipation shall be designed considering outlet velocities and hydraulic jumps. Rip-rap shall not be placed on the outlet apron. See Standard drawings SD-26 and SD-27

I. Water and Soil Tight System

1. All storm drain pipe, manholes, and fitting connections, including drain inlet laterals shall be water and soil tight and tested in conformance with the City's Standard Construction Specifications.
2. A note shall be placed on the improvement plans stating these requirements and that the contractor is responsible for providing equipment and labor for performing tests and making measurements when directed to do so by the City's inspector.

J. Bored and Jacked Pipe

All casing pipes shall be sealed at both ends in such a manner as to provide water resistant seal.

K. Backfill Seepage

A concrete filled cutoff barrier shall be utilized at inlets and outlets where water may periodically penetrate pipe backfill material.

9-13. MANHOLES & JUNCTION BOXES

Requirements for manholes are as follows:

- A. Standard pre-cast concrete or saddle type manholes shall be used except where special manholes or junction boxes are required. The design of special manholes and junction boxes must be submitted to the Director for approval. Cast-in-place manholes shall conform to the Standard Drawings.
- B. All manholes shall be a minimum 48 inches inside diameter unless approved on an exception basis by the Director. In no case shall junction boxes or manholes be allowed which are smaller than twenty-four inches (24") inside dimension.
- C. Manholes shall be sized to provide a minimum of nine inches (9") wall spacing between annular cutout edges of pipe openings.
- D. Manholes shall be located at junction points, angle points greater than 15 degrees, and changes in pipe size or materials. On curved pipes with radii of 200-feet to 400-feet, manholes shall be placed at the beginning and end of curve and on 300-foot maximum intervals along the curve. On curves with radii exceeding 400-feet, manholes shall be placed at the beginning and end of curves and on 400 foot maximum intervals along the curve for pipes twenty-four inches (24") and less in diameter and 500-foot maximum intervals along the curve for pipes greater than twenty-four inches (24") in diameter. Manhole spacing on curves with radii less than 200-feet shall be determined on an individual basis. Exceptions to these calculated

manhole placements shall be allowed if the resulting manholes are within 100 feet of existing or proposed manholes.

- E. Spacing of manhole, junction boxes (or inlets of such size as to be accessible for maintenance) shall not exceed 400-feet for drains fifteen inches (15") and smaller in diameter, 500-feet for drains between eighteen inches (18") and thirty-six inches (36") in diameter, and 600-feet for pipes greater than thirty-six inches (36") in diameter.
- F. All manholes and junction boxes other than inlets shall have standard manhole frames and covers as shown in the Specifications. Manhole and junction box covers shall be marked "STORM DRAIN" in raised lettering. Manholes shall not be allowed in the gutter or sidewalk.
- G. A reinforced flat top forty-eight inch (48") diameter (no cone) concrete lid as shown in the Construction Specifications shall be required when any pipe would enter the manhole above any portion of the base of a manhole cone. Maximum twenty-four inch (24") diameter riser (chimney) height shall be less than or equal to eighteen inches (18").
- H. Use grated manhole covers (Drawing SD-11) to pick up minor drainage in non-traffic areas only if debris clogging is not a concern.
- I. Improvement plans shall include a special detail for all manholes at junction points where there is a change in pipe direction for pipe diameters exceeding forty-eight inches (48").
- J. Resilient connectors, in conformance with Section 39-2.02 of the Specifications, are required between pre-cast manhole/box and pipe, and between pre-cast drop inlet and pipe. Water stops are required for pipe to cast-in-place manhole/drop inlet connections. Use non-shrinking/non-expansive grout for making connections of pipe and water stop to structure walls.
- K. Stations of manholes/boxes shown on project drawings apply at center line of shaft.
- L. Manhole/box lids shall be bolted to frame where lids are prone to surcharging when the storm drain system is at maximum capacity. A pressure manhole design may be required by the Director.
- M. Storm drain manholes/boxes shall be tested in conformance with the Standard Construction Specifications.
- N. There shall be no sumps in manholes outside of the public right-of-way. Manholes and junction boxes located outside of paved areas shall have rim set 0.5 feet above ground surface.
- O. Drop inlets shall not be used as junction boxes, unless approved by the Director.
- P. Junction boxes shall be constructed of pre-cast or cast in place reinforced concrete with minimum wall thickness of six inches (6"). The Consulting Engineer shall submit calculations indicating the junction box is designed to withstand H-20 loading.

- Q. The inside vertical dimension of junction boxes shall be such as to provide a minimum of three-inch (3") clearance on the outside diameter of the largest pipe in each face. Junction boxes shall have a minimum horizontal inside dimension of forty-eight inches (48"). All junction boxes shall be rectangular unless otherwise approved by the Director.
- R. Pipes adjacent to junctions shall have tight, impermeable joints subject to testing requirements of Section 39-4.02 of the Specifications.
- S. Junction boxes larger than ten feet (10') in any dimension shall have two manhole access points.

9-14. INLETS

- A. Always use grated inlets when the longitudinal slope of the street exceeds 4% where due to the high velocities it is difficult to direct the flows into the curb opening.
- B. All inlet design curves in these Standards assume clean inlets. The Consulting Engineer shall assume a 50% clogging factor when determining the number and location of inlets.
- C. Additional inlets are required at sump locations per Section 9-11A of these Standards.
- D. Type B inlets are typically used for streets with concrete curbs and gutters. See Figure 9-3, for flow capacity.
- E. Type J Inlets are to be used when inlet invert exceeds 5' below gutter flow line.
- F. Type F inlets may be used in roadside ditches, swales, unimproved medians, and outside of the road right-of-way. Figure 9-4 provides design capacity for one two-foot wide window of a Type F inlet, clear of debris.
- G. Curb opening catch basins with grating(s) and debris skimmers may be used in locations where additional inlet capacity, beyond a single Type B inlet, is needed, or as where directed by the Director. The inlet width may vary from seven feet (7') to twenty-eight feet (28'). The H dimension is the gutter depression depth and shall be a standard two inches (2"). When more than one grate is required, use Drawing SD-16 for support assembly. Assure that the lateral is sized to serve the increased inlet capacity. Flow capacity of inlets is calculated using the methods found in the Federal Highway Administration (FHWA) Urban Drainage Design Manual Hydraulic Engineering Circular No. 22.
- H. Inlets in Class "A" and "B" streets shall be placed at lot lines in residential subdivisions and at the curb return of intersections. Inlets shall be placed so that the length of flow does not exceed 500 feet, unless otherwise approved by the Director. Inlets at curb returns shall be constructed so that they are not in conflict with the Americans with Disabilities Act requirements for ramps. No face plates are allowed on inlets at the curb returns.

- I. Type F inlets shall be designed based on Figure 9-4. The chart assumes clean openings, so some clogging shall be accounted for by adding a grated lid or increasing the window opening(s).
- J. Inlet markings must be provided in the concrete at each drop inlet per Section 11-15 of these Improvement Standards.

9-15. OVERLAND RELEASE

Piped storm drain systems are not designed to convey peak flow from infrequent high intensity storm events. When the pipes and inlets are clogged or overwhelmed, surface runoff will pond in low areas and flow overland along designed overland release routes. The improvement plans shall include overland release routing and the consulting engineer shall provide supporting calculations. Risk of flood damage shall be reduced by insuring that the 100-year storm runoff ponds and flows through the proposed development with appropriate freeboard protecting existing and proposed structures, pursuant to Section 9-1 of these Standards. Hydraulic and erosion control calculations for overland release flows must be provided with the design.

- A. For the purposes of determining overland release flows, the 100-year runoff shall be determined using the Sacramento Method. For purposes of overland flow design, the designer may assume the storm drain pipes are flowing full into 100-year downstream water surface condition, or may actually calculate the flow conditions using the 100-year storm event with a 10-year HGL as the starting water elevation for the downstream channel.
- B. All arterial streets and selected collector streets (when determined by the Director), shall be designed with at least one traffic lane in each direction completely above the 100-year HGL elevation.
- C. The 100-year HGL elevation of overland flows on streets shall not exceed the back of sidewalk elevation by more than six inches (6") on streets with vertical curbing and eight inches (8") on streets with rolled curbing.
- D. Where the overland release path leaves the paved right-of-way, concrete improvements shall be constructed as a mow strip, gutter or other permanent flow line. Decorative use of stamped concrete is encouraged. The use of grouted paving stones or cobbles is acceptable as long as they are placed on top of a two (2) inch minimum concrete base, are solid grouted, and do not protrude into the invert elevation/flow line. The outlet of the overland release flows must be similarly armored with a concrete apron. Additionally, energy dissipation features must be placed at the end of the apron and/or formed within the apron concrete.
- E. Streets, publicly-owned parking lots, pedestrian areas, pedestrian walkways, utility routes and other open space areas may be considered compatible uses for the overland release routing. Appropriate barricades for traffic safety and signage as required by the City shall be placed as needed for release paths exiting the right-of-way.

9-16. PIPE STUBS

The criteria for pipe stubs shall be as follows:

- A. A headwall or flared end and trash rack shall be required where the upstream pipe ends at a park or open field, and the site shall be graded toward the inlet.
- B. Temporary pipe stubs shall be as deep as possible to provide for future extension, and raised to grade using a Type F, Type H, or Type I inlet or other appropriate catchments. Type H Inlets shall be sized two (2) sizes larger than the connecting pipe or pipe stub.

9-17. HEADWALLS AND RACKS

The requirements for headwalls, wing-walls, end walls, trash racks, access control racks and railings are as follows:

- A. All headwalls, wing-walls and end walls shall be considered individually and in general shall be designed in accordance with the Standards and Specifications of the California Department of Transportation.
- B. Erosion control is of high importance where storm drain pipes discharge to natural channels. Energy dissipating structures shall be detailed on the improvement plans. Pipe and culvert entrance and outlet locations shall be provided a concrete apron with minimum lengths as required in Sections 9-12 (H) and 9-23 for erosion control and maintenance purposes.
- C. Trash racks shall be provided on inlets to pipes entering an underground conduit system. Trash racks shall be designed such that the ratio of trash rack open area to drain opening is at a minimum four to one (4:1).
- D. Access control racks shall be required on pipe outlets forty-two inches (42") or larger, unless access is restricted by fencing and omission is approved by the Director. The Director may require racks at smaller pipe outlets in locations that are deemed to warrant supplemental access control. Racks shall not be installed on open-ended culverts, unless required by the Director.
- E. Both trash and access control racks shall hinge at the top to allow them to open should debris and hydraulic forces provide pressure.
- F. Racks on pipe outfalls 37 to 66-inch diameter shall be constructed as two separate hinged sections. For pipe outfalls greater than 66-inch diameter, the racks shall be split into three sections.
- G. Public safety may require metal beam guardrail, chain link fencing, or other protective railing as approved by the City, at the top of culverts, headwalls, box culverts, and steep side slopes. Installation shall be in accordance with the Specifications.
- H. Slopes around headwalls, wing walls, end walls, trash racks and other concrete structures shall be protected from erosion appropriately.

9-18. DRAINAGE PUMPS

Drainage pumping stations shall be designed in accordance with the latest edition of the Hydraulic Institute Standards and as specified by the Director. A pump station shall include the following minimum features:

- A. A standby backup pump.
- B. An automated debris removal system at the inlet.
- C. A diesel powered generator with automated start and stop and a 3 hour supply of fuel shall be part of the station.
- D. A low flow pump shall be required to accompany any drainage pump station.
- E. Automated control systems linked to a SCADA system.
- F. Standardization of models and manufacturers of equipment in existing City-operated stations.

9-19. DETENTION SYSTEMS

Detention basins can be used for peak flow attenuation, detention, and retention and/or storm water treatment. Flood control detention system designs must be performed for all detention/retention basins, temporary or permanent.

- A. Detention basin volume requirements shall be determined based on a 100-year, 24-hour storm. For the 100-year 24-hour volume, the basin must have 2 feet of freeboard. The total volume required for the basin shall be based on hydrologic routing computations detailed by the Hydrology Standards of the Sacramento City/County Drainage Manual. Basin routing curves shall be included in the design calculations submitted.
- B. Detention basins shall have gravity inflow and outlet facilities providing terminal drainage capable of emptying a full basin within 72 hours. Detention basins with pump station outflow may also be considered with the approval of the Director. Downstream limitations must also be considered in sizing the pumping facility.
- C. Side slopes of the basin and any berm shall be no more steep than 4:1. Shape shall be irregular and slopes shall vary around the basin to give it a more natural appearance, up to approximately 10:1 slopes. Bottom of the basin must slope towards outlet at a minimum 2% slope if vegetated or 0.5% if paved.
- D. The bottom of the basin shall be a minimum of 2 feet above the highest ground water elevation and be based on the recommendation of a licensed engineering geologist or soils engineer.
- E. The basin shall have a 20-foot wide access road around the entire perimeter of the basin with a concrete access ramp into the basin. A concrete apron shall be constructed at the bottom of the basin for maintenance equipment staging.

- F. If a water quality structure is included in the basin design, the volume of the water quality portion of the basin shall be in addition to the volume required for detention. The water quality element of the basin must be designed according to the above referenced design standards and the Storm Water Quality Design Manual for the Sacramento and South Placer Region. See Chapter 11.
- G. Approved detention basins shall require submittal of a "User Manual" for each detention basin prior to acceptance by the City. This manual shall include an 11"x17" sheet showing details of the detention basin including: inlets, outlets, ramps, elevation, and a vicinity map showing the access route from the arterial and the 10- and 100-year elevations.

9-20. OPEN CHANNELS

All runoff for new development must normally be conveyed in closed conduits. Utilization of open channels may be authorized by the Director whenever one or more of the following applies:

- 1. The design flow rate exceeds the capacity of a seventy-two inch (72") pipe.
- 2. The outfall is at an elevation such that minimum cover cannot be obtained over the pipe.
- 3. Government policies require that the channel remain natural. A parallel facility for runoff conveyance may be considered. If an agreement is needed between a State and Federal Agency, such agreement must be approved by the Director prior to its submittal to other agencies.

Open channels are to be designed pursuant to the drainage study provided by the Consulting Engineer and to the satisfaction of the Director. Each project has unique hydraulic constraints and storm water quality requirements; therefore, the following shall be deemed guidelines.

- A. Open channels may consist of vegetated earth channels. Concrete lining may also be used.
- B. Criteria for open channels shall be as follows:
 - 1. Open channel design shall include a water surface profile analysis using the Army Corps of Engineers HEC-RAS computer program, UNET program or other steady or unsteady state hydraulic program, approved by the Director.
 - 2. Open channels shall be designed to convey the 100-year flood event with a minimum one foot (1') of freeboard. Greater freeboard may be required depending on the sensitivity of the model, obstructions, and surrounding property.
 - 3. The minimum velocity for open channels is 1.5 ft/s. The maximum velocity for the 100-year flood event shall be as follows:
 - a.) Earth channels, six (6) ft/s

- b.) Lined channels, ten (10) ft/s
 - c.) Bottom-lined channels, eight (8) ft/s
4. Super elevating the outside bank on bends may be required to maintain specified freeboard.
 5. The centerline curve radius of an open channel shall be equal to the greater of twice the bottom width or thirty-five feet (35’).
 6. Earth channels and the side slopes of bottom lined channels shall be vegetated with native grasses or other permanent vegetative cover. All vegetation shall be approved by the Director. Vegetation shall be established prior to the wet season (October 1). Hydro-seeding conducted during the wet season (October 1 – April 30) shall include additional appropriate soil stabilization materials to prevent erosion, in accordance with Section 11 of the Improvement Standards. A note shall be added to improvement plans stating, “Vegetated open channels shall not be accepted by the City until 70% of the vegetation is established.” No trees shall be planted below the 10-year hydraulic grade line.
 7. Channels, deeper than two feet (2’), shall be constructed to a typical cross section with 3 horizontal to 1 vertical (3:1) or flatter side slopes. Exceptions require a soils report and the approval of the Director.
 8. All channels deeper than 2 feet shall have a minimum bottom width of six feet (6’).
 9. Permanent erosion protection shall be placed at the top of the cut or bank to prevent erosion (see Standard Drawings). At locations where overland flows enter the channel, appropriate erosion control and energy dissipation methods shall be incorporated into the design.
 10. For all channels, either improved or natural, the following items shall be shown on improvement plans in addition to information heretofore required:
 - a.) Typical sections and cross-sections.
 - b.) Profile of the existing channel and top of bank profile including enough of the existing channel each side of the development to establish an average profile grade through the development.
 - c.) Ten and one-hundred year water surface elevations.
 - d.) Road crossings with road profile indicating overland release.

9-21. OUTFALL PLANS

Requirements for outfall plans are as follows:

- A. All permanent and temporary drainage outfalls shall be shown in both plan and profile on the improvement plans for a distance until a definite “daylight” condition is established.
- B. The profiles shall include ditch flow-line and left and right top of bank elevations.

- C. When improvements have more than one unit or phase, the drainage outfall shall be shown as extending to the property boundary and beyond, if required, although it may not be constructed with the current unit development.

9-22. SITE REQUIREMENTS

- A. FENCING - Fencing shall, unless approved otherwise by the Director, be required around all City drainage facilities. The specific design and materials used are subject to the approval of the Director. The minimum requirements for fencing are as follows.
 - 1. Fencing shall be six foot (6') chain link or "decorative" style, located six inches (6") inside of right of way or easement.
 - 2. Pedestrian gates shall be four feet (4') wide.
 - 3. Vehicle gates shall be two eight foot (8') gates with a total opening of sixteen feet (16') wide. They shall be set a minimum of twenty feet (20') back from the edge of pavement to allow for a safe parking area off of the traveled way while opening and closing the gates. Gates must swing away from road right-of-way. A concrete driveway shall be provided at vertical curb locations. Asphalt concrete paving shall be provided between the traveled way and drive gate. Design the paving per Section 9-22 B4 of these Standards.
 - 4. Signs may be required as considered appropriate by the Director. As a minimum, the vehicle gate access shall be marked "City of Elk Grove Drainage Facility – No Motorized Vehicles - No Parking". Signage statements, sizes, layout, and colors shall be approved by the Director.
 - 5. Fencing and gates components shall be composed of unpainted galvanized steel. Other materials such as aluminum, or other approved durable and corrosion-resistant materials may be used if decorative fencing is required for the area. Weld joints shall be cleaned and covered with a zinc-based coating.
- B. ACCESS ROADS - Every drainage ditch, basin, channel, and underground pipeline outside the right-of-way shall have an access road for maintenance, normally located at or above the 100-year flood elevation. An area with a minimum width of 20 feet shall be set aside for access.
 - 1. A twenty foot (20') service road shall be provided having a sixteen foot (16') improved surface and two foot (2') shoulders on each side. Curve radii shall be a minimum of forty-two feet (42'). Turnouts shall be placed as dictated by horizontal sight distance and shall be no greater than one-thousand feet (1000'). Turn-around shall be placed at all dead ends.
 - 2. For ditches less than 8 foot wide from bank to bank at the top of the ditch, a narrower 14 foot service road with a 10 foot improved surface and 2 foot shoulders with lesser turn radii and no turn-outs may be authorized.

3. For roads with no outlet, a turn-around shall be constructed with a minimum 40 foot outer radius at the end of the road.
 4. Improved surfaces of the service road shall be a minimum six inches of AB. The center 10 feet of a 20 foot service road shall be paved, with a minimum of 2 inches of AC on 5 inches of AB. Existing sub grade shall be compacted to 85% and AB shall be compacted to 90%.
- C. RAMPS - Access ramps are required to the bottom of open channels and basins that are more than 4 feet below the service road to allow access for emergency and maintenance equipment. Each segment of a channel shall be accessible. Ramps shall be located in pairs where possible to allow entrance and exit of equipment.
1. The minimum width shall be twelve feet (12') at a maximum slope of 10%. See Drawing SD-25.
 2. Ramps shall be constructed of concrete; minimum 4 inches thick with appropriate base (may be colored to blend with the surroundings). Attention to both aesthetics and serviceability is required. Materials with characteristics similar to concrete may be substituted on an exception basis if authorized by the Director.
 3. Details of the ramps shall be shown on the improvement plans.

9-23. CROSS CULVERT CRITERIA

The following standards apply when the 100-year water surface elevation is not freely spanned by a bridge:

- A. Cross culverts for minor sheds shall be designed in accordance with procedures outlined in the U.S. Department of Transportation "Hydraulic Design of Highway Culverts," Hydraulic Design Series No. 5, latest edition. For shed areas greater than 160 acres, use HEC-RAS or other software approved by the Director.
- B. Cross culverts shall be checked against 100-year runoff to assure that no adverse effect will occur upstream or downstream.
- C. Cross culvert profile shall be determined by an examination of the overall profile of the channel for a minimum distance of 500-feet on each side of the installation, assuring that freeboard requirements are met, and inlet or outlet control shall be determined.
- D. Where no overland release is possible, cross culverts shall be oversized by at least 25%.
- E. Where roads are not to be overtopped, for public safety or physical constraints, the box culvert soffit shall have one-foot (1') of freeboard over the 100-year water surface elevation.
- F. Culverts shall include a headwall or flared end section at both the upstream and downstream end. A concrete apron shall be provided at the inlet and outlet of a

culvert, with the minimum length of the lesser of 20 (twenty) feet or five (5) pipe diameters.

9-24. DRAINAGE IN RURAL AREAS

Closed conduit pipelines, not open drainage ditches, shall be utilized for runoff collection and conveyance along public right-of-ways, except in rural residential areas zoned for agricultural/residential lots at least 2 acres in size. Non-roadside ditches shall use the criteria for open channels and may require private easements to be recorded for cross lot drainage.

When appropriate, open roadside ditches shall use the criteria for design of Class "C" streets and the following requirements:

- A. Roadside ditches shall be sized to convey design runoff. Analysis of 100-year flows shall be considered per Section 9-1. Analysis shall include culverts. The 10-year and 100-year hydraulic grade lines shall be shown on the profile. A minimum grade of 0.3% or a minimum velocity of 1 ft/second shall be secured.
- B. Roadside ditches shall use 4:1 or flatter side slopes. Roadside ditches, including slopes, shall be completely contained within the right-of way. See also Section 4 of these standards.
- C. Driveway culverts shall be designed to pass the greater of the 10-year design runoff, the roadside ditch capacity, or a 12 inch minimum diameter. Culverts shall be constructed out of CMP or RCP pipe. Driveway side slopes shall be 3:1 or flatter. Culverts shall be installed with either a six inch (6") thick concrete collar and headwall; or shall extend at least 1 foot beyond the driveway side slope and include a flared end section at the upstream and downstream ends.

9-25. STORM DRAIN SYSTEMS IN PRIVATE STREETS

- A. Private storm drain systems that connect to City maintained drainage facilities shall have a manhole immediately upstream of the connection within the public easement or right-of-way.
- B. It shall be made clear on the plans which facilities are privately owned and appropriate signage shall be erected to inform the public.
- C. Private storm drain pipes serving more than two parcels shall be built per these Improvement Standards.

**Table 9-4
Minimum Pipe Cover Requirements**

Pipe Material Type and Location	Minimum Cover Requirement
High Density Polyethylene (HDPE) – non traffic areas	Twenty-four (24”) – top of pipe to top of grade
Corrugated Metal	Span/8 but not less than twelve inches (12”)
Spiral Rib – Steel	Span/3 but not less than twelve inches (12”)
Spiral Rib – Aluminum with spans less than or equal to 72”	Span/2 but not less than twelve inches (12”)
Spiral Rib – Aluminum with spans greater than 72”	Span/3 but not less than thirty inches (30”)
Reinforced Concrete in unpaved areas	1/8 the diameter or rise (the greater of) but not less than twelve inches (12”)
Reinforced Concrete under flexible pavements (Class IV and V)	1/8 the diameter or rise (the greater of) but not less than twelve inches (12”)
Reinforced Concrete under flexible pavements (Class I, II, and III)	1/8 the diameter or rise (the greater of) but not less than twenty-four inches (24”)
Reinforced Concrete under rigid pavements	A nine-inch (9”) space between top of pipe and bottom of slab consisting of compacted granular fill shall be maintained at a minimum.
Cast-in-Place-Concrete-Pipes in paved areas	The structural section (AC & AB) plus twenty-four inches (24”)
Cast-in-Place-Concrete-Pipes in unpaved areas	Twenty-four inches (24”)
Polyvinyl Chloride – C900 and C905	Twelve inches (12”)
Polyvinyl Chloride – D2241 and D3034	Twenty-four inches (24”)

Note: All depths shown are for a minimum trench width equal to the outside diameter of the pipe plus sixteen inches (16”) measured at the top of the pipe.

**Table 9-4a Maximum Pipe Cover Requirements - Concrete and Plastic Pipe
Measured to bottom of trench in feet**

DIA.	RCP					Cast in Place	PVC	HDPE			
	Class										
	I	II	III	IV	V						
12	Not Permitted	8	12	30	No Limit	No Limit	14	49			
15		10	15	35			14	45			
18		11	16	38			14	43			
21		12	17	39			14				
24		12	18	39			14	43			
27		13	19	39			14				
30		14	19	38			Not Permitted	34			
33		14	20	38							
36		13	17	27				69	45		
42		14	18	29				62	38	46	
48		15	19	30				60	30	41	
54		16	20	31				58	26		
60		14	16	21				31	57	24	48
66		15	17	22				32	56	21	
72	15	18	23	33	56	21					

Note: All depths shown are for a minimum trench width equal to the outside diameter of the pipe plus sixteen inches (16") measured at the top of the pipe.

**Table 9-4b Maximum Pipe Cover Requirements - Metal Pipes
Measured to bottom of trench in feet**

DIA.	CMP **					Ribbed Steel Pipe			Ribbed Aluminum Pipe							
	Thickness - inches					Thickness - inches			Thickness - inches							
	0.064	0.079	0.109	0.138	0.168	0.064	0.079	0.109	0.060	0.075	0.105	0.135				
12	99	No Limits														
15	99															
18	99															
21	99	99														
24	93	99														
30	74	93											99			
36	62	78	99	99				36	50	67	21	29	49	64		
42	53	66	93	99				30	40	56	17	24	40	51		
48	46	58	81	99				26	35	48	14	21	34	44		
54	47	52	72	93	99	21	31	41	13	18	30	37				
60	43	53	65	84	99	20	28	38	12	17	26	34				
66	39	48	68	76	93	19	26	34				15	25	31		
72	35	42	62	70	85							25	32	14	23	28
												22	30	21	26	
									22	28	20	25				

- Note
- 1) All depths shown are for a minimum trench width equal to the outside diameter of the pipe plus sixteen inches (16") measured at the top of the pipe.
 - 2) ** Normal pipe corrugation profile is 2 2/3" x 1/2". The corrugation of the pipes within the shaded box area shall have profile of 3" x 1" or 5" x 1".
 - 3) When flow velocity exceeds five (5) feet per second, the next thicker gauge shall be used for CMP pipe.

**FIGURE 9-3
TYPE B INLET FLOWS**

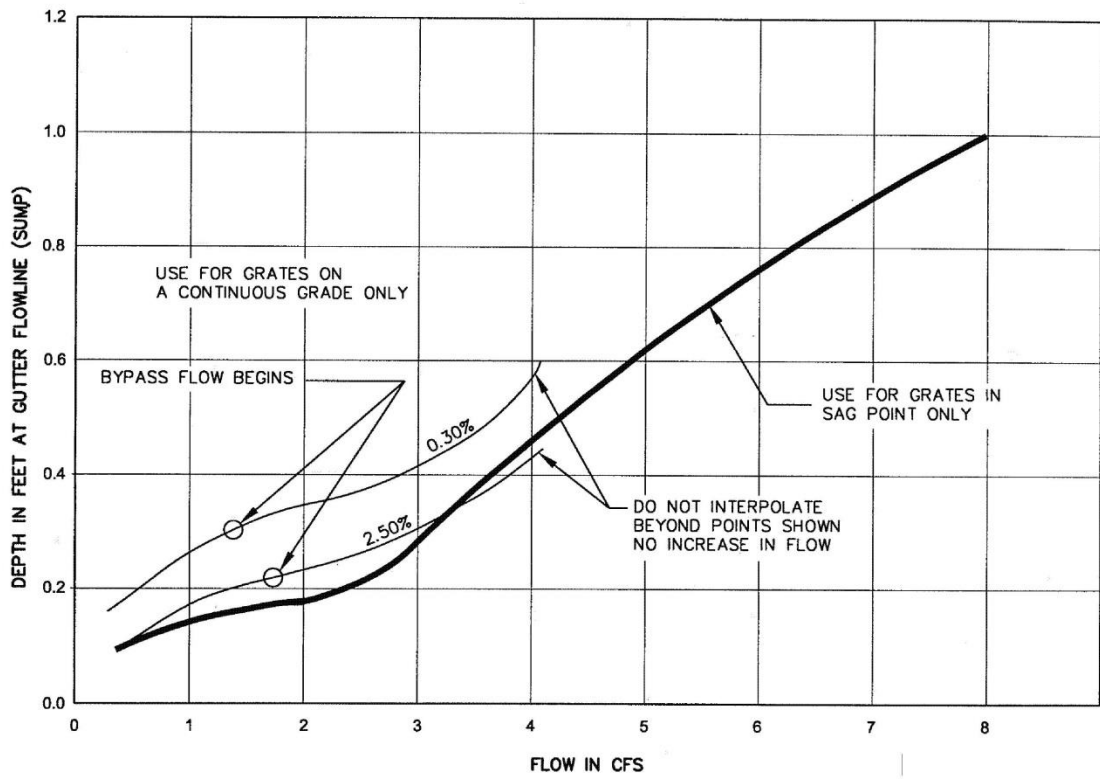

**FIGURE 9-4
 TYPE F INLET FLOWS**

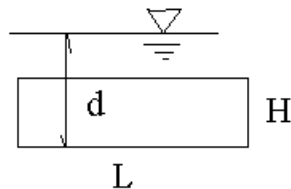
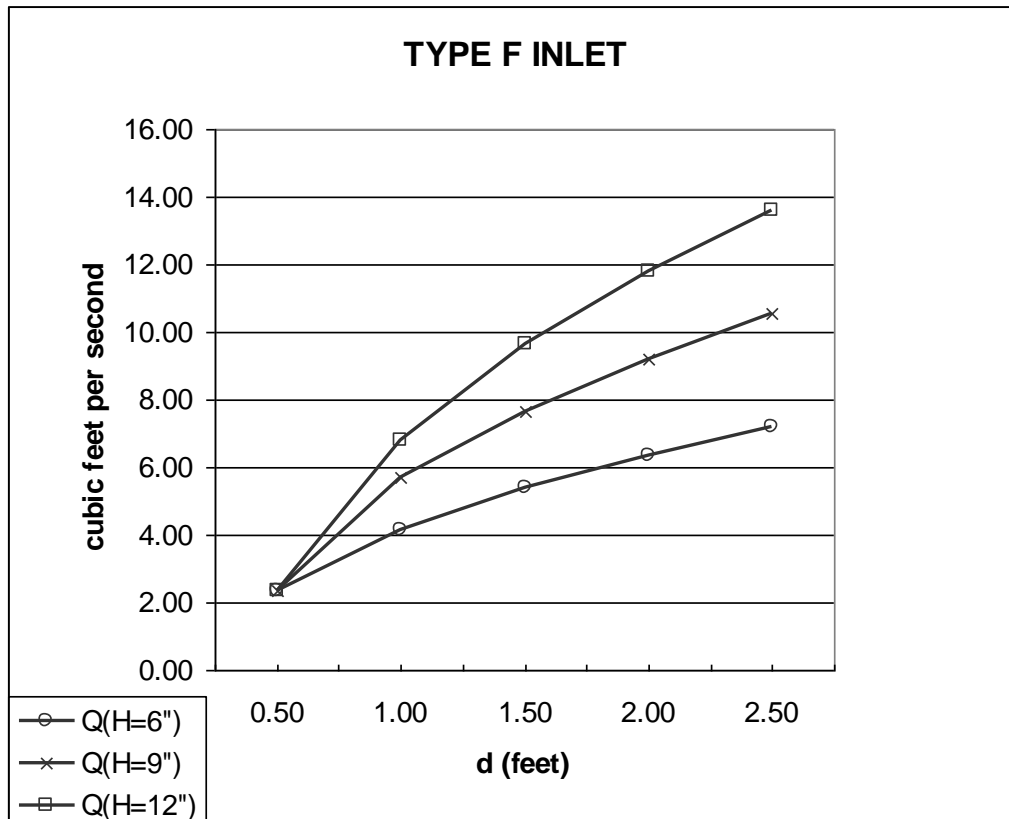

$$Q_{\text{weir}} = 3.33L d^{1.5} \quad (d < H)$$

$$Q_{\text{weir}} = 0.60(2gd)^{0.50} \quad (d > H)$$

Figure 9-5

The US Department of Transportation recommends, in Hydraulic Engineering Circular Number 22, the use of the following equation when the depth at the gutter is less than one fortieth (1/40) the width of flow. It is a variation of the Manning's formula because the hydraulic radius does not adequately describe the gutter cross section. The compound gutter and rolled curb are considered negligible and are ignored.

$$Q = \frac{K_C}{n} S_x^{1.67} T^{2.67} S_L^{0.5}$$

Where: Q = flow rate (ft³/sec)

K_C = 0.56 (English units)

n = Manning's coefficient (use 0.016 for paved street)

T = width of flow or spread (ft)

S_x = cross slope, typically 0.020 (ft/ft)

S_L = longitudinal slope (ft/ft)

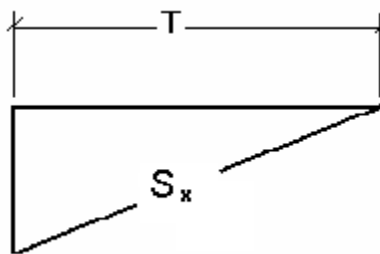

Depth at gutter = TS_x

SECTION 10

GRADING

10-1. GENERAL REQUIRMENTS

Grading during the wet season (typically October to April) shall be limited and phased for erosion control purposes.

10-2. PLAN SHEET DETAILS

In addition to the requirements of Section 3, the following items shall be included on grading plans:

- A. Slope symbols for 3:1 slopes or steeper, where grade difference exceeds one foot
- B. Ridge and/or valley delineation
- C. Typical lot grading details
- D. Proposed spot and/or pad elevations
- E. Flow directional arrows (off-site, around perimeter of development when adjacent to developed areas) and perimeter elevations at the property line
- F. Existing spot elevations and/or contour lines on-site and off-site around perimeter of development. Where the existing terrain is not relatively flat, contour lines shall be mandatory. The spot elevations or contour lines shall be extended off-site for a minimum distance of 50 feet (flat terrain – 100 feet minimum) when adjacent to undeveloped areas.
- G. Existing vegetation including trees (variety, size and elevation at base of all trees nine inches or larger)
- H. Retaining wall details (symbols, construction details, limits, and top and bottom of wall elevations)
- I. Back of sidewalk or curb elevations
- J. Location and grate elevation of storm drain inlets
- K. Typical sections across side yard property lines where the difference in finish pad elevations exceeds two feet. Delineated on the section shall be the side yard drainage swale and minimum distance between the proposed building and the side yard property line.
- L. Names of adjacent subdivisions
- M. Off-site intersecting property lines
- N. Signature block for certification of pad elevations by Consulting Engineer for subdivision projects

- O. For all export projects:
 - 1. Location and plan of spoils disposal
 - 2. Spoils slopes of 3:2 or flatter
 - 3. Finish spoils heights of 3 feet or less
 - 4. No spoils within 5 feet of property lines
 - 5. Spoils shall not block drainage
 - 6. Spoils shall be leveled prior to acceptance of project
- P. Erosion control details as required in Section 11.
- Q. Overland release grades and details.

10-3. ROLLING TERRAIN GRADING

Grading or rolling terrain shall be accomplished in a manner whereby the profile of the rolling terrain is maintained as close to that which exists as practically possible. Interior cuts and fills shall be no greater than 5 feet.

10-4. BOUNDARY GRADING

Special attention shall be given to grading adjacent to the exterior perimeter property line of a development. All adverse effects to off-site properties adjacent to new developments shall be reduced to an absolute minimum. Fills and cuts adjacent to the exterior perimeter property line shall be designed in accordance with the following:

- A. Fills – Fills in excess of 2 feet shall not be allowed unless permitted by project conditions of approval. When fills are unavoidable, they shall conform to Standard drawing G-1. If possible, fill slopes shall be constructed off-site, with the property line being situated at the top of the fill. A right of entry shall be required for all off-site fills prior to plan approval. A note shall be placed on the plans listing the name of the grantor of the right of entry and the date obtained.
- B. Cuts – Cuts shall be constructed in accordance with Standard drawing G-2, except that the slope setback from the property line to the slope hinge point shall be a minimum of 2 feet for all slopes steeper than 5:1.
- C. Fences – When fences are required, they shall be placed within one foot of the property line. Where the adjacent property is City owned or public right-of-way, the wall shall be placed on the private property side of the boundary. The height of a fence shall be measured from the highest ground adjacent to the fence, regardless of the side that is developing.

10-5. INTERIOR GRADING

Grading at interior property lines within a subdivision shall conform to Standard drawing G-2 and the following:

- A. Property Lines – Property lines shall be situated at the top of fill and cut slopes. Grading shall be such that surface runoff will not be allowed to sheet flow down the slopes steeper than 5:1. Property lines shall be situated at the top sides of retaining walls with a minimum setback of 1.0 foot from the property line to the retaining wall. See Standard drawing G-3.
- B. Slopes – The maximum earth slopes allowed shall be 2:1 (horizontal to vertical) and the minimum shall be 1%. Minimum asphalt concrete surface slopes shall be 1% and minimum Portland cement concrete slopes shall be 0.25.
- C. Cross Lot Surface Flow – Grading of residential or duplex lots shall be such that surface flow shall be restricted to a maximum of one lot flowing across another lot. Developments with situations that mandate grading which allows more than one lot to drain across another lot shall be required to provide a pipe system to maintain the one-lot rule.
- D. Lots on the low side of streets and at sag points shall be graded in such a manner as to preclude flooding of the building pad area in the event of malfunction or overloading of the street drainage system. All building pad grades shall be a minimum of 1 foot above the overland release elevation.
- E. Commercial developments shall not be allowed to “sheet drain” more than twenty-five feet of site frontage to a public street. Area outside the 25-foot strip shall be graded to drain into an on-site drainage system.

10-6. RETAINING WALLS

Retaining walls shall be in accordance with the following:

- A. Redwood retaining walls for interior property lines shall conform to Standard drawing G-3 as a minimum design. Construction details of redwood retaining walls on the plans shall not be required when reference to Standard drawing G-3 is made. When fences are to be constructed atop redwood retaining walls, 4" x 6" posts at 4' centers shall extend above the retaining wall and act as fence posts.
- B. Masonry or concrete retaining walls for boundary or phase lines shall conform to Standard drawing G-4 as a minimum design. Construction details of masonry or concrete retaining walls on the plans shall not be required when reference is made to Standard drawing G-4.
- C. Design calculations stamped and signed by the Consulting Engineer shall be required for all walls exceeding 24 inches in height (excluding footing height) or when a fence greater than 6 feet high is an integral part of the wall.
- D. All retaining walls within 8 feet of boundary, phase, or right-of-way lines shall be either concrete or masonry.
- E. Grading shall be such that on-site-runoff will not flow over retaining walls.

- F. Where pads on adjacent lots are 10' apart or less and the difference in elevation exceeds 2.5 feet, a retaining wall will be required as per Standard drawings G-3 or G-4.

10-7. GRADING AT TREES

The City of Elk Grove desires to preserve the existing trees within the City whenever reasonably possible. The regulations governing these preservation objectives are in Chapter 19.12, Tree Preservation and Protection, of the Elk Grove Municipal Code.

10-8. CERTIFYING PAD ELEVATIONS

Upon completion of the grading and prior to acceptance of the subdivision improvements by the City, the Consulting Engineer shall verify the final pad elevations. The elevations shall be verified at the center and the corner of each pad. Elevation deviations more than 0.10 feet shall be noted on the plans.

A signature block, certifying that final graded elevations in the field are the same as those shown on the plans, shall be included on the subdivision grading plans. The Consulting Engineer shall sign the signature block, certifying to the above, and shall provide three sets of record (as-built) grading plans to the Director.

10-9. MAINTENANCE OF ACCESS TO UTILITY FACILITIES

Continuous, suitable access shall be maintained during all stages of construction of any facility owned or operated by a utility/district providing essential services, i.e., sanitary sewer, water, drainage, electricity, gas, telephone, etc.

SECTION 11

STORMWATER QUALITY PROTECTION

11-1. DEFINITIONS / ACRONYMS

BMP	Best Management Practice
CGP	General Permit for Storm Water Discharges Associated with Construction Activity (Construction General Permit)
ESCP	Erosion and Sediment Control Plan
FORECASTED RAIN	a 30% or better chance of rain as forecasted by the National Oceanic & Atmospheric Association (www.noaa.org)
MS4	Municipal Separate Storm Sewer System
NOI	Notice of Intent
NPDES	National Pollutant Discharge Elimination System
RWQCB	Regional Water Quality Control Board
SWPPP	Storm Water Pollution Prevention Plan (Project SWPPP's must be site specific)
SWRCB	State Water Resources Control Board
Wet Season	October 1st through April 30th annually
WPCP	Water Pollution Control Program (Project WPCP's must be site specific)

PART I – CONSTRUCTION PRACTICES

11-2. STORMWATER POLLUTION PREVENTION PLAN (SWPPP)

Applicants meeting the project area disturbance threshold of one (1) acre or more of disturbed area shall obtain coverage under the SWRCB General Permit for Storm Water Discharges Associated with Construction Activity (Construction General Permit (CGP)), prior to commencing construction activities. Coverage must be obtained by filing an NOI with a vicinity map and the appropriate fee with the SWRCB. Projects smaller than one (1) acre of disturbed soil area shall prepare a Water Pollution Control Plan (WPCP).

- A. The CGP requires development and implementation of a SWPPP. The CGP emphasizes the use of appropriately selected, correctly installed and maintained pollution reduction BMPs. This approach provides the flexibility necessary to establish BMPs which can effectively address source control of pollutants during changing construction activities.
- B. All dischargers shall prepare and implement a SWPPP prior to disturbing a site. The SWPPP must be implemented at the appropriate level to protect water quality at all times throughout the life of the project. Non-stormwater BMPs must be implemented and maintained year round. The SWPPP shall remain on the site while

the site is under construction, commencing with the initial mobilization and ending with the termination of coverage under the CGP.

- C. The SWPPP has six major objectives: (1) identify all pollutant sources, including sources of sediment that may affect the quality of storm water discharges associated with construction activity (storm water discharges) from the construction site, and (2) identify non-storm water discharges, and (3) identify, construct, implement in accordance with a time schedule, and maintain Best Management Practices (BMPs) to reduce or eliminate pollutants in storm water discharges and authorized non-storm water discharges from the construction site during construction, and (4) develop a maintenance schedule for BMPs installed during construction designed to reduce or eliminate pollutants after construction is completed (post-construction BMPs), and (5) identify a sampling and analysis strategy and sampling schedule for discharges from construction activity which discharge directly into water bodies listed on Attachment 3 of the Permit (Clean Water Act Section 303(d) [303(d)] Water Bodies listed for Sedimentation) and (6) for all construction activity, identify a sampling and analysis strategy and sampling schedule for discharges that have been discovered through visual monitoring to be potentially contaminated by pollutants not visually detectable in the runoff.
- D. Minimum required elements of a SWPPP include:
1. A vicinity map showing nearby roadways, the construction site perimeter, and the geographic features and general topography surrounding the site.
 2. Site description addressing the elements and characteristics specific to the site with a detailed, site-specific listing of the potential sources of storm water pollution.
 3. A site map showing the construction project in detail, including the existing and planned paved areas and buildings; general topography both before and after construction; drainage patterns across the project area; and anticipated storm water discharge locations (i.e., the receiving water, a conduit to receiving water, and/or drain inlets)
 4. Erosion and Sediment Control Plan with descriptions of BMPs to be employed.
 5. BMPs for construction waste handling and disposal.
 6. Implementation of approved local plans.
 7. Proposed post-construction controls, including description of local post-construction erosion and sediment control requirements.
 8. Non-stormwater management.
 9. The name and telephone number of the qualified person responsible for implementing the SWPPP and certification/signature by the landowner or an authorized representative

- E. SWPPP's will be modified and amended to reflect any amendments to the Permit, or any changes in construction or operations that may affect the discharge of pollutants from the construction site to surface waters, groundwaters, or the municipal separate storm sewer system (MS4). SWPPP's will also be amended if they are in violation of any condition of the Permit or has not achieved the general objective of reducing pollutants in storm water discharges. SWPPP's shall be readily available on-site for the duration of the project.
- F. Prior to approval of Improvement Plans, a copy of the NOI for coverage under the CGP with assigned WDID number shall be submitted to the City. Prior to commencing construction, the SWPPP, with its ESCP, will be submitted and reviewed by the City for adequacy. The City shall use the accepted SWPPP in conducting its inspections and monitoring under the City's NPDES permit requirements.

11-3. EROSION AND SEDIMENT CONTROL PLAN (ESCP)

All projects must have adequate and effective combinations of erosion and sediment control BMPs properly implemented, installed, and maintained.

- A. Improvement Plans shall include an Erosion and Sediment Control Plan, which shall be prepared and approved per the requirements of Chapter 16.44 of Title 16 of the City Municipal Code, Land Grading and Erosion Control Ordinance. These plans may be incorporated into the Grading Plans or on separate sheets for clarity.
- B. The ESCP shall be designed to ensure that the following minimum requirements are effectively implemented at applicable construction sites:
 - 1. Sediments generated at the project site shall be controlled using adequate source control and/or structural BMPs;
 - 2. Construction-related materials and wastes shall be retained at the project site to avoid discharge to the MS4 and waters of the state;
 - 3. Unauthorized non-storm water runoff shall be contained at the project site; and
 - 4. Erosion from slopes and channels shall be controlled by implementing an effective combination of erosion and sediment control BMPs such as limiting grading during the wet season; inspecting graded areas during rain events; planting and maintenance of vegetation on slope; and covering erosion-susceptible slopes.
 - 5. The locations for construction BMPs need only be general in nature on improvement plans subject to more specific locations being noted in the SWPPP at the pre-construction conference.
- C. Specific locations for construction access, washouts, waste disposal sites, signage, portable toilets, and other BMP-related facilities must be provided as a supplement to the Erosion and Sediment Control Plan at the preconstruction meeting. During the pre-construction meeting, for projects involving greater than 1.0 acre, the

Applicant/contractor shall provide the City with a SWPPP supplementing the initial ESCP, showing the locations of BMPs and BMP-related facilities whose location is dependent on construction execution planning such as the access points, disposal points, and washouts.

11-4. CONSTRUCTION BEST MANAGEMENT PRACTICES (BMPs)

All projects shall employ appropriate temporary and permanent BMPs during construction. Construction disturbing more than 1 acre shall include BMPs in the SWPPP and Erosion and Sediment Control Plans. Smaller projects shall select and utilize BMPs as necessary to adequately control erosion, sediment, tracking, non-storm water management, materials and waste.

The City of Elk Grove uses the California Storm Water Quality Association's (CASQA) Construction Storm Water Best Management Practice Handbook as its selection guide for selecting temporary BMPs. BMPs used for construction activities shall be selected and employed in accordance with CASQA guidelines. Drawings in these standards may also be used for employment of BMPs. Equivalent BMP guidelines generally accepted by California agencies and in general use within the State may also be used, but must be so identified and justified in the ESCP.

NOTE: The following paragraphs describe selected City of Elk Grove minimum requirements in the employment of BMPs. These requirements are not to be considered comprehensive and must be supplemented as needed to be in full compliance with CGP.

- A. Tracking Control - Access points to the construction site shall have a stabilized construction access. A stabilized access consisting of a pad of coarse aggregate underlain with filter cloth located where traffic enters or leaves a construction site to minimize tracking of sediment from a construction site onto paved streets is required. (Drawing SQ-1). This practice may be supplemented by an entrance/outlet tire wash area. Placement of stabilized construction access points shall be clearly defined on the improvement plans. Streets adjacent to construction access points shall be swept as needed, to remove dirt and sediment tracked into the roadway.
- B. Preservation of Existing Vegetation - Maintain areas of existing vegetation, utilizing stable vegetated areas to help reduce the amount of sediment in sheet flow runoff and to minimize the extent of disturbed area. Examples of how existing vegetation can be preserved include:
 - 1. Buffer strips adjacent to wetlands and other sensitive areas in conjunction with sediment controls (fiber roll or silt fence).
 - 2. As perimeter protection along property lines, in conjunction with sediment controls (fiber roll or silt fence).
 - 3. Maximize undeveloped portions of a job site.

Areas of vegetation to be preserved shall be clearly marked on plans and fenced or flagged in the field. Traffic and stockpiles shall be located away from vegetated areas. Irrigation and maintenance requirements shall be specified on the plans.

C. Erosion Control

1. Inactive Disturbed Soil - Inactive disturbed soil areas, and associated earthen concentrated flow lines and conveyances, not being worked or scheduled to be worked for an extended period of time during the wet season, must be stabilized.
 - a) During the wet season, inactive disturbed soil areas must be stabilized within 15 calendar days of cessation of work or prior to a forecasted rain event, whichever comes first.
 - b) Residential lots that have not yet been landscaped shall have the at least the first 18 feet behind the sidewalk (first 7.5 feet for side yards) stabilized by hydroseeding or other method.
2. Slope protection - All slopes greater than 10:1 shall be protected through the use of effective erosion controls.
3. Practices - Such practices may include preserving existing vegetation, Silt Fencing (SQ-5), Straw Mulch, Geotextiles, Erosion Control Blankets/Mats (SQ-9A and SQ-9B), Velocity Dissipation Devices, and Hydroseeding. Hydroseeding, if used, shall be implemented in advance of the time when there is risk of erosion. Hydroseeding applied after September 15 and before April 30 shall be further protected with straw mulch, soil binder, or an erosion control blanket/mat.

D. Sediment Control - Sediment control BMPs shall be used to settle and trap sediments before they reach the municipal storm sewer system.

1. Roadway Subgrades and Depressions - Subgrades and depressions during construction shall be protected from discharging pollutants during overflow.
2. Perimeters - Sediment control BMPs shall be placed and maintained along the project perimeter where drainage flows from the project and at all inlets to the municipal storm drainage system for the duration of active construction.
3. Practices - BMPs may include the use of Fiber Rolls (SQ-4), Silt Fencing (SQ-5), Inlet Barriers, and Sediment Traps (SQ-3).
4. Drain Inlet Protection - Storm drain inlets shall be protected against intake of construction site sediment, debris and solid waste.
 - a) Place drainage inlet protection BMPs at storm drain inlets. BMPs shall include Inlet Sediment Control Barriers (SQ-7), and Inlet Filter Bags (SQ-8). Inlet sediment control devices are placed on

the upstream side of drainage inlets. For inlets in gutter low points, inlet sediment control devices shall be installed on both sides of the inlet.

- b) Inlet sediment control devices shall remain in place until soil disturbing activities are completed and adjacent areas are stabilized with permanent erosion control.
- c) Filter bags and frames shall be placed such that low flow surface water does not bypass the filter bag.

E. Wind Erosion Control

Each construction site shall employ proper and adequate wind erosion and dust control BMPs such as applying water and other dust palliatives.

F. Non-Stormwater Management

Each construction site shall provide designated paint, concrete, solid and liquid waste disposal locations and washout locations as necessary. Plans shall indicate locations and designs as appropriate.

1. Concrete washouts will be designed for project sites where concrete is used as a construction material, and concrete trucks and other concrete-coating equipment are washed on site, including mortar and stucco operations. Plans shall include locations of directional signage for drivers as well as the details and locations of the washout facility. Above grade washouts must be lined and bermed.
2. Each construction site shall provide proper, water tight, storage of construction materials with secondary containment for hazardous liquids. Sites shall have an emergency response plan and proper spill kits and containment materials.
3. Each construction site shall provide proper and adequate water tight solid waste containers.

11-5. SCHEDULE

A BMP installation schedule shall be included in the SWPPP and/or on the included erosion and sediment control plans. The schedule shall include the BMPs for both the wet season and the dry season.

11-6. MONITORING AND MAINTENANCE

A critical element of stormwater quality protection during construction is maintaining BMP facilities and monitoring BMPs in place regularly. Designs must include, in the SWPPP or on the plans, the specific requirements for monitoring the effectiveness of BMPs before, during and after storm events and during routine dry weather operations.

Maintenance requirements will be in the design documents and must ensure the following:

- A. BMP facilities are functioning as designed.
- B. BMP facilities and practices are preventing pollutants from entering the City municipal storm drain system, creeks and channels.
- C. BMP facilities are not causing street or property flooding.
- D. All BMPS's are routinely inspected, maintained and documented in the site SWPPP.

PART II – NEW DEVELOPMENT CONTROL MEASURES

The City of Elk Grove is a partner in the Sacramento Stormwater Quality Partnership. Stormwater Quality Protection facilities shall conform to the requirements established by this multi-jurisdictional program.

SECTION 12

SURVEY MONUMENTS

12-1 SURVEY MONUMENT REQUIREMENTS

A. The Consulting Engineer shall place monuments at the following locations within subdivision improvements and all roadway improvements:

1. At the intersection of all street centerlines.
2. At the beginning and end of all curves on street centerlines.
3. At the subdivision boundary corners designated by the Director and other such locations so as to enable any lot or portion of the improvement to be retraced or located.

The monuments shall be as follows:

1. Subdivision boundary monuments, except those in street pavement shall be not less than two-inch (2") O.D. galvanized iron pipe, 30 inches in length, capped and tagged.
2. Subdivision boundary monuments in street pavement shall be not less than one-inch (1") O.D. galvanized iron pipe, 18 inches in length, capped and tagged. Top of pipe shall be driven flush with the surface pavement.
3. Centerline and street intersection monuments shall be 2 ½" brass disc in well castings (monument wells) per the City of Elk Grove Standard drawing ST-40. Centerline monuments for each subdivision shall include at least two monument wells that are intervisible and at least 500 feet apart, with other centerline monuments on two-lane streets being iron pipe as described in the preceding paragraph or six-inch boat spikes with a washer bearing the license number of the responsible surveyor/engineer.

All centerline monuments shall be referenced to permanent objects and ties shall be furnished to the Director for general public use. Final approval of the subdivision will not be made until such ties have been furnished to the Director.

B. Survey monuments shall be placed by the Consulting Engineer at all the following locations within the improvement, and off-site, due to deed dependency, as required by the City:

1. Section corners
2. Quarter corners
3. Center of sections.

A monument for a section corner, quarter corner, or center of section shall be a 2½" brass disc in well castings per the City of Elk Grove Standard Drawings.

Where such points lie outside of the ultimate City right-of-way, monuments for section corners, quarter corners, and centers of section, may alternatively be class "B" concrete, poured in place, with minimum dimensions of 8 inches by 8 inches by 24 inches. Ferrous material shall be placed in the monument to make it locatable with a magnetic locator. A metal survey disc shall be installed by the Consulting Engineer before the concrete has acquired its initial set and shall be firmly embedded in the concrete.

- C. The Consulting Engineer shall show the location and character of all survey monuments within the construction area and place a note on all construction plans stating the Contractor is responsible for the protection of all existing monuments and other survey markers in accordance with Section 8771 of the Land Surveyor's Act.

SECTION 13

TRAFFIC SIGNAL DESIGN

13-1. DESIGN STANDARDS

Traffic signals, intersection safety lighting and electrical systems shall be designed in accordance with Part 4 of the California Manual on Uniform Traffic Control Devices for Streets and Highways, Sections 9-06 thru 9-13 of the California Traffic Manual, California Signal and Lighting Design Guide, the applicable State Plans, and the applicable provisions of Section 86, "Signal, Lighting and Electrical Systems", of the State Specifications.

13-2. GENERAL PLAN REQUIREMENTS

The traffic signal/safety lighting plans shall include pertinent traffic signal notes, in addition to all designed features, for the project.

13-3. PULL BOXES

Pull boxes for traffic signal shall be designed to locate outside all access ramp areas. Such requirements shall be stipulated on the traffic signal/safety light plans as a special note.

13-4. SIGNAL INTERCONNECT

All traffic signals shall be connected to the City's Traffic Management Center (TMC) via signal interconnect to the nearest traffic signal. The signals shall be connected using a 20 pair signal interconnect cable (SIC) and be placed in a conduit that is at least 2.5" internal diameter. Conduit and SIC shall meet all requirements in the most recent version of the State Standard Plans.

For new traffic signal construction, SIC shall be installed in the cabinet in such a way to allow communication between the City's Traffic Management Center and the signal using a modem from the City's pre-qualified signal component list. The City shall be consulted prior to design and will provide the most current pre-qualified list.

13-5. LIGHTING TYPE CONSISTENCY

For those areas requiring decorative street lights in Section 5, interior signalized intersections shall be designed to reflect the decorative type of the development.

A. Zone 2

1. Safety Lighting - All luminaire arms and fixtures mounted on traffic signal poles at intersections in the Zone 2 area shall be designed in accordance with designated requirements unique to the area.
2. Coating - All traffic signal poles, mast arms, luminaire arms, and internally illuminated street name sign support arms at intersections in the Zone 2 area shall be required with a stock color black super-durable TGIC polyester powder coat finish prior to installation. Such requirements shall be stipulated on the traffic signal/safety lighting plans as a special note.

B. Common Type (CT)

1. Safety Lighting - Standard safety lighting shall be used in areas designated for common type street lights.
2. Finish - Standard galvanized steel poles, mast arms and luminaire arms shall be used.